

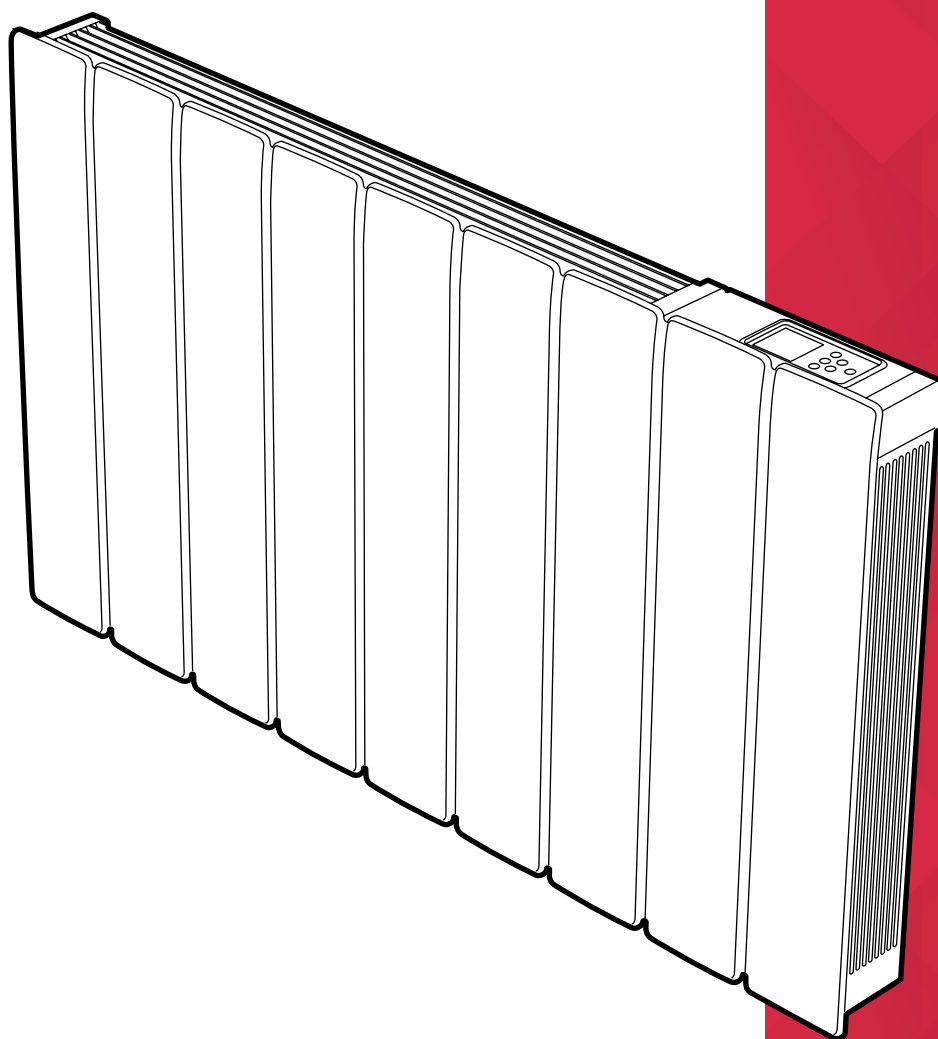

INSTRUCTION MANUAL

Installation and Operating



Dimplex Monterey (MFPE)

Models: MFP050E / MFP075E / MFP100E
MFP150E / MFP200E

These instructions should be read carefully and retained for future use. Note also the information presented on the appliance.



IMPORTANT

THESE INSTRUCTIONS SHOULD BE READ CAREFULLY AND RETAINED FOR FUTURE REFERENCE. **Note also the information presented on the appliance**

CAUTION: FAILURE TO FOLLOW THESE INSTRUCTIONS MAY CAUSE INJURY AND/OR DAMAGE AND MAY INVALIDATE YOUR GUARANTEE

IMPORTANT SAFETY ADVICE

When using electrical heaters, basic precautions should always be followed to reduce the risk of fire, electrical shock, and injury to persons, including the following:

IMPORTANT: The wall bracket supplied with the heater must be used.

IMPORTANT: All packaging should be disposed of in an appropriate manner.

OVERHEATING WARNING

WARNING: In order to avoid overheating, do not cover or obstruct the heater. Do not place material or garments on the heater, or obstruct the air circulation around the heater, for instance by curtains or furniture, as this could cause overheating and a fire risk. NEVER cover or obstruct in any way the heat outlet slots at the top of the heater or the air inlet slots in the base of the heater.



WARNING: THE SURFACES ON THIS HEATER CAN BE HOT. The heater carries a warning 'DO NOT COVER' to alert the user to the risk of fire that exists if the heater is accidentally covered. DO NOT place combustible items through the heater grille.

CAUTION: Some parts of this product can become very hot and cause burns. Particular attention has to be given where children and vulnerable people are present.

For your safety this heater is fitted with a thermal cut-out. In the event that the product overheats for some reason, the cut-out prevents excessive temperatures on the product by cutting the power to the heater. Once the heater has cooled down, it will reset automatically, it will continue to cycle on and off automatically until the reason for overheating is removed. The display screen may flash red to indicate the product has overheated. To reset the display, remove the obstruction and hold Enter for 10 seconds.

SUITABLE APPLICATIONS

WARNING: This heater is suitable for normal domestic household purposes and should not be used in any other type of environment. This product should only be used in the country where it was purchased from by a recognised commercial retailer.

Do not use outdoors.

SERVICING AND REPAIRS

WARNING: Servicing and product repairs should only be undertaken by the manufacturers approved service agent or a similarly trained or qualified person, using only exact manufacturer approved spare parts.

PLEASE NOTE: Household dust, lit cigarettes, candles and oil burners, combined with the convection effect of electric heaters can cause significant soot deposits to build up on the surface directly above and to the sides of the heater. This is not a fault of the heater. Extensive burning of candles or smoking in the operating environment of this product can produce heavy discolouration within a few months of use.

OPERATING WARNINGS

IMPORTANT: Remember to observe all safety warnings and precautions when operating the heater on the automatic or timer modes, either attended or unattended since a fire risk exists when the heater is accidentally covered or displaced.

CAUTION: Do not use if the heater's mains power lead is damaged. If the supply cord is damaged it must be replaced by the installer or an approved Dimplex service partner.

ELECTRICAL INSTALLATION

WARNING: The electrical installation of this heater must be carried out by a suitably qualified or trained electrician, and be in strict accordance with the current wiring Regulations BS 7671. The supply must be connected via a switched fused spur with a fuse rated suitably for the appliances flex. Failure to follow these instructions will mean that the manufacturer's instructions have not been adhered to. **THERE ARE NO EXCEPTIONS.**

WARNING: Minimum clearances and IP zone requirements must be adhered to in accordance with the current wiring regulations.

The wires in this mains lead are coloured in accordance with the following code:

GREEN AND YELLOW: EARTH

BLUE: NEUTRAL

BROWN: LIVE

- This heater must be earthed
- Not suitable for connection via a plug top
- Do not locate the heater immediately below a fixed electrical point i.e. socket outlet.

The heater is fitted with a length of flexible cable type H05VV-F size 3 x 1.0mm² for 500W to 2kW models for connection to the fixed wiring of the premises through a suitable connection box positioned adjacent to the heater. A means for disconnection must be incorporated in the fixed wiring of the premises in accordance with the current wiring regulations. The supply circuit to the heater must incorporate a double pole isolating switch having a contact separation of at least 3mm. Products that are supplied without a plug are for installation into the fixed wiring of the property, via a suitable double pole switched fused spur with a fuse rated suitably for the appliances flex. Typical fuse ratings for 230V equipment - Up to 700W = 3A, over 700W = 13A.

In installation the supply cord must be cut to the appropriate length for the electrical connection point. Excess cable should not be inserted and stored behind the heater.

WARNING: This heater must not be connected to the electricity supply via an external switching device (such as a timer) or a circuit that is regularly switched on and off by the utility supplier. Failure to follow this warning could result in the heater's thermal cut-off being inadvertently reset and could create a fire hazard. Cables/flexes that are supplied pre-fitted to the product must NOT be extended.

CHILD SAFETY

WARNING: This appliance is not intended for use by persons (including children) with reduced physical, sensory or mental capabilities, or lack of experience and knowledge, unless they have been given supervision or instruction concerning use of appliance by a person responsible for their safety.

This appliance can be used by children from 8 years and above and persons with reduced physical, sensory or mental capabilities or lack of experience and knowledge if they have been given supervision or instruction concerning use of the appliance. Children shall not play with the appliance. Cleaning and user maintenance shall not be made by children without supervision. Children of less than 3 years should be kept away unless continuously supervised.

Children aged from 3 years and less than 8 years shall only switch on/off the appliance provided that it has been placed or installed in its intended normal operating position and they have been given supervision or instruction concerning use of the appliance in a safe way and understand the hazards involved. Children aged from 3 years and less than 8 years shall not plug in, regulate and clean the appliance or perform user maintenance. This product contains a replaceable battery.

WARNING: KEEP BATTERIES OUT OF REACH OF CHILDREN.

WARNING: Packaging should be disposed off responsibly as the EPS could be a potential choking hazard for children

Energy Related Product Directive

This product meets the Ecodesign requirements for an electric fixed local space heater. Commission Regulation (EU) 2015/1188.

Type of heat output/ room temperature control	
With electronic room temperature control	Yes
Electronic room temperature control plus week timer	Yes
With open window detection	Yes
With adaptive start control	Yes

Contact details

Glen Dimplex Heating and Ventilation

Millbrook House, Grange Drive, Hedge End, Southampton, SO30 2DF

Tel: 0344 879 3588

Technical Details

Model Identifier(s):		MFP050E	MFP070E	MFP100E	MFP150E	MFP200E
Nominal heat output	P _{nom}	0.5kW	0.75kW	1 kW	1.5kW	2.0kW
Height (mm)		536	536	536	536	536
Width (mm)		503	503	671	741	911
Depth (mm)		104	104	104	104	104
Minimum heat output (indicative)	P _{min}	N.A	N.A	N.A	N.A	N.A
Maximum continuous heat output	P _{max,c}	0.5	0.75	1	1.5	2
Auxiliary Electricity Consumption						
At nominal heat output	e _{lmax}	0.00	0.00	0.00	0.00	0.00
At minimum heat output	e _{lmin}	0.00	0.00	0.00	0.00	0.00
In standby mode	e _{lSB}	<0.0005	<0.0005	<0.0005	<0.0005	<0.0005
With open window detection		Yes				
With adaptive start control		Yes				

All Models

Controls	Digitally controlled, Electronic Thermostat accurate to (± 0.2 oC) Timer modes: 7 Day Programmable User Timer, Out All Day, Home All Day, Away Mode Continuous heat modes: Eco, Manual, Frost Protect, Setback
Controller UI	<ul style="list-style-type: none">• Open window detection, Adaptive-start• Advance time period• Adjustable max setpoint range (7-30°C)• Bluetooth for software updates• Child Lock & Landlord Lock (PIN-based)
Construction	<ul style="list-style-type: none">• Durable epoxy-polyester powder coated steel casing with louvered upward facing grille• Advanced controls with capacitive sense technology for total flexibility of heating
Colour/ Finish	Metal Chassis, Air Outlet Grille & Control Moulding - Traffic White (RAL 9016)
Element	Compact, finned, mineral filled sheathed element
Installation	Wall bracket
Safety	<ul style="list-style-type: none">• Thermal cut-out. Auto reset type• Overheat detection
IP Rating	IP24
Battery	3.3V coin cell battery to backup real time clock. Battery life >5 years.
Supply	1.3 metres fitted, 3 core for fused spur installation, 1/N/PE -230-240 V, 50Hz Class I, with earth wire
Approvals	UKCA, CE and BEAB
Warranty	2 years
Country of Origin	United Kingdom
Manufacturer	Glen Dimplex Heating & Ventilation (Glen Dimplex UK Ltd.)

General Information

Please read the instructions closely before first using the product, there is also a quick-start guide on page 10 if you need a reminder of how to use the basic functions in the future. The heater is designed for wall mounting using the wall bracket supplied. It should only be operated when in the upright position as shown - see **Fig.3** and **Fig.4**. All models are splash proof to IP24. Before connecting the heater check that the supply voltage is the same as that stated on the heater.

Wall Mounting Instructions



WARNING:
This product is heavy and care should be taken in installation

IMPORTANT - The wall bracket supplied with the heater must be used and the heater must be installed in the correct orientation. The fixings should be used to secure the bracket to the particular wall on which the heater will be installed. The heater should be positioned observing the minimum clearances stated around the heater - see **Fig. 2**, **Fig. 3** and **Fig. 4**.

MODEL	A	B	C	D	E
MFP050E	390mm	150mm	503mm	536mm	104mm
MFP075E	390mm	150mm	503mm	536mm	104mm
MFP100E	560mm	150mm	671mm	536mm	104mm
MFP150E	630mm	150mm	741mm	536mm	104mm
MFP200E	800mm	150mm	911mm	536mm	104mm

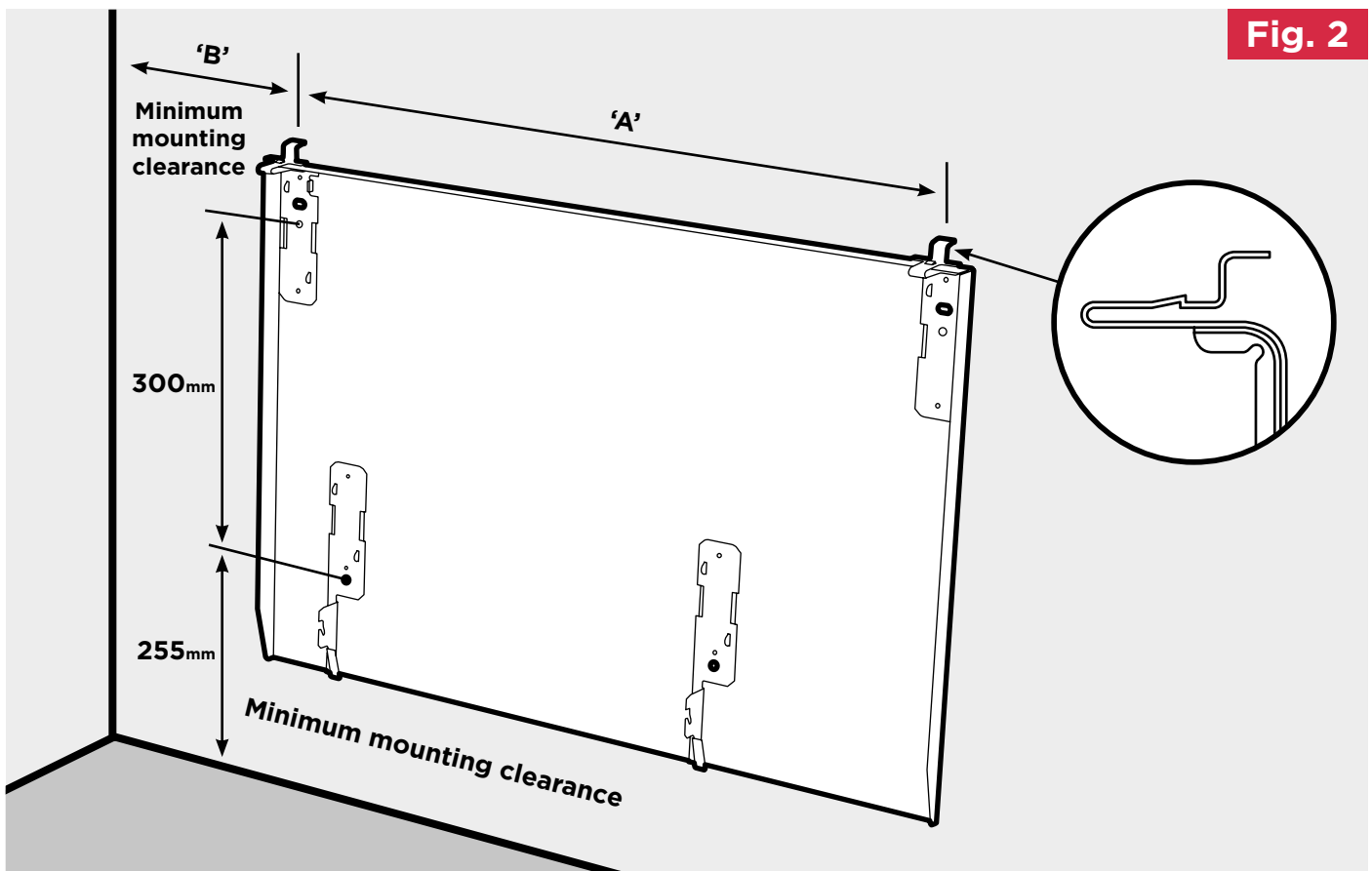

Fig. 2

To mount the heater to the wall:

1. Remove wall mounting bracket from the back of the heater by depressing the spring latch at the side of each bracket - see **Fig.2**.
2. Fix the wall bracket securely to the wall through the four screw holes. Ensure only screw fittings suitable for the particular wall type are used.
3. Present the heater to the wall bracket and engage bottom slots in the back with bracket hooks.
4. Press the top of the heater into locked position and ensure the clips on the top are engaged.

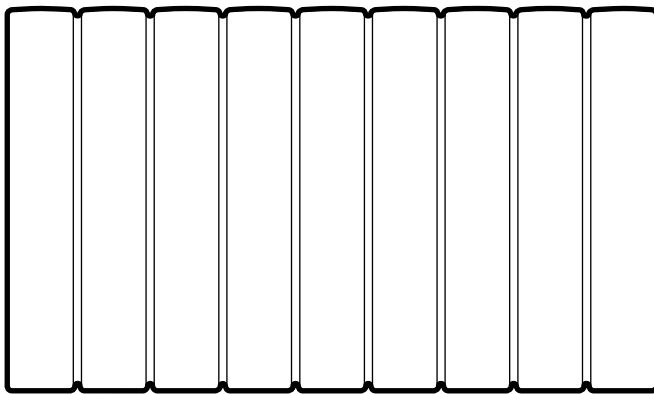

Fig. 3

Minimum mounting clearance

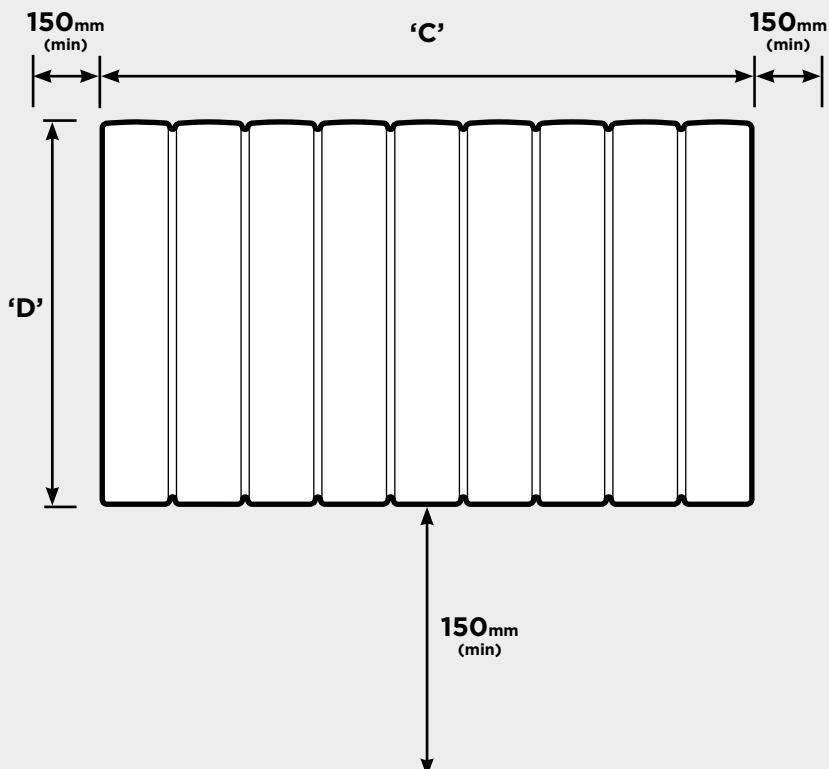
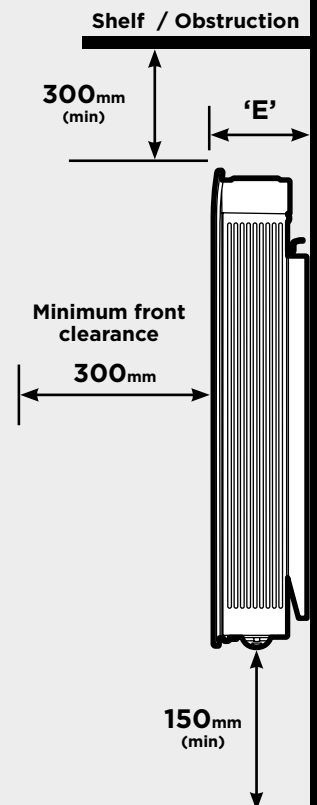

Fig. 4



***Please note correct product orientation is with controller facing top right side only**

First Time Power-On

A setup wizard will display when the product is powered on for the first time. This will set the following:

- Time, Date, Daylight Savings Time
- Sound On/Off

For information on using the Heaters controls, refer to page 12.

The Heater will then take the User to the Home Screen with the 'Out All Day' Timer Mode active.

Important

During initial heat-up, some odour may be emitted due to the newness of materials used in manufacture. This is normal and will disappear after a short period of use. It is however advisable to keep the room well ventilated.

Operation Manual

WARNING: FAILURE TO FOLLOW THESE OPERATING INSTRUCTIONS MAY RESULT IN INJURY AND/OR DAMAGE.

The controls are located on top of the heater. This consists of a display screen and six touch sensitive buttons.

- 1 Display Screen
- 2 'Menu' Button
- 3 'Back' Button
- 4 'Up and Down' Arrows
- 5 'Enter' Button
- 6 'Advance' Button
- 7 Heating Status

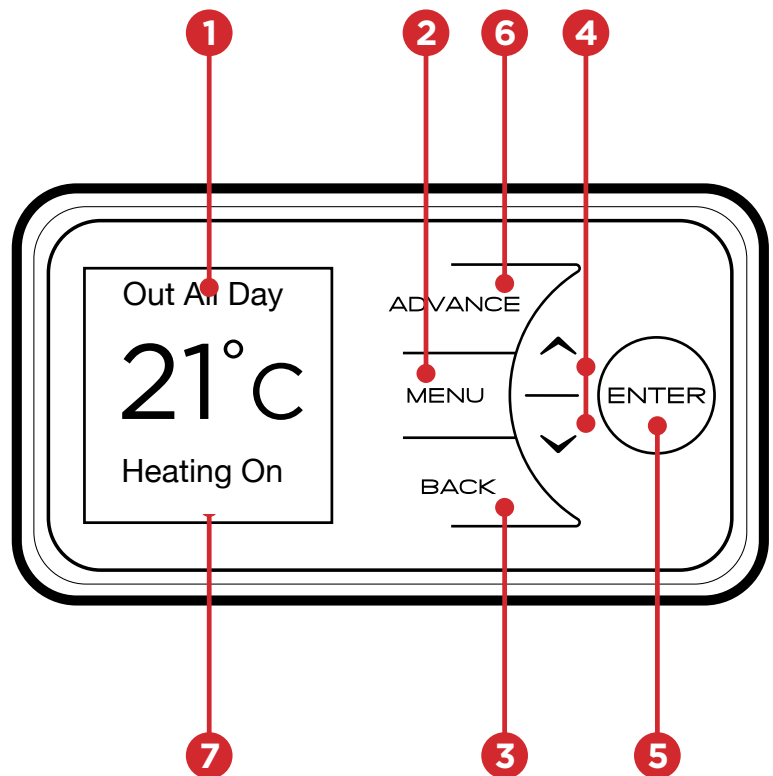

The heater is fitted with an adjustable thermostat enabling the room temperature to be controlled. The minimum room temperature is 7°C. The maximum temperature is set to 30°C. A temperature of 21°C is a common comfortable room temperature.



NOTE:

Your heater may produce some noise during operation. This noise is caused by the expansion and contraction of the element as it changes temperature, and is normal for this type of product. Whilst the noise produced is usually very quiet, certain environmental factors can make it more noticeable, such as hard flooring or minimal furnishings. If you believe that the expansion noise is excessive, please contact us.



NOTE:

Should the heater fail to operate, this may be caused by the room temperature being higher than the thermostat setting.

The heater controls can be easily adjusted by using the six buttons on the User Interface.

1. The Home Screen shows the options available at each stage of adjustment. Here the current target temperature (setpoint) is displayed along with the mode of operation. Any use of the Advance function will be displayed here, and pressing Enter will show the functions which are enabled.

The currently active mode of operation is displayed at the top of the screen e.g. **'Out All Day'** timer.



When the heater is trying to achieve or maintain a room temperature, **'Heating On'** will be displayed, otherwise, **'Heating Off'** will be displayed.

When the controller buttons have not been pressed for a long period of time, the display will 'sleep' and the text will disappear. The heater is still on and active in whatever Mode it was set to.

2. Menu - Displays the Main Menu;

- **Boost** - Activate Boost Mode
- **Modes** - Set the mode of operation.
- **Settings** - Time/Date, Temperature units etc.

3. Back returns to the previous screen.

4. The Up and Down buttons are used to navigate through the menus and adjust the required room temperature on the main screen. The screen colour changes based on the temperature selected, showing deep blue through to bright red.

5. Enter is used to enter sub menus and to confirm actions.

6. The Advance button is only used when a Timer Mode is active, it allows the timer schedule to be changed temporarily by forcing a **Heating On** period to begin or end early. For more information, see page 17.

Timer Modes

Timer Modes offer the most efficient mode of operation for a predictable heat demand. Additional functions such as 'Advance' and 'Boost' allow the User to make temporary adjustments to timer schedules for a more flexible operation.

Each timer is broken down into 4 definable '**Heating On**' time periods and temperatures per day, for each day of the week. Each day consists of a 24-Hour period, starting and finishing at midnight.

'**Heating On**' periods are times when the heater is trying to achieve and maintain the target room temperature.

It is possible to change the **Target Temperature** of a **Heating On** period when that period is active. This will temporarily adjust the **Target Temperature** for just that instance and will not permanently modify the settings for the timer in use.

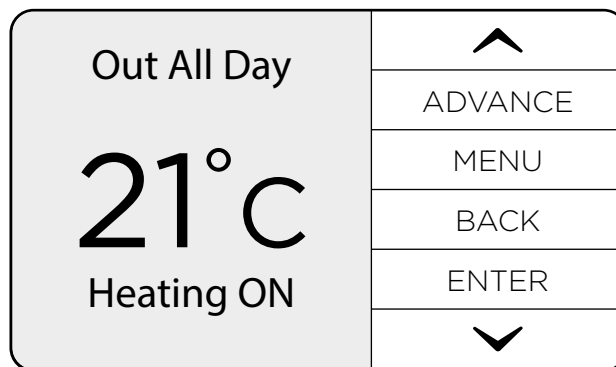

NOTE:

If Adaptive Start is enabled, the heater will maintain the room at the required temperature for the duration of the heating period. To achieve this, the heater will begin heating the room before the start of the heating period to ensure the room is at the required temperature when the period starts.

If Adaptive Start (AS) is disabled, the heater will not operate until the beginning of the heating period. This should be taken into consideration when setting the heating periods.

See page 21 for instruction on enabling/disabling Adaptive Start.

Available Timer Modes

To choose a timer mode, press **Menu** from the home screen. Use the arrow keys to highlight 'Modes', then press **Enter** to select. 'Timer Mode' should be highlighted, press **Enter** to select.

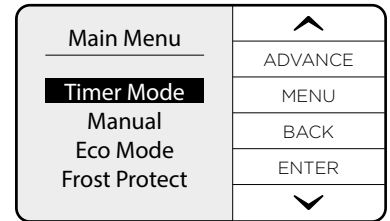
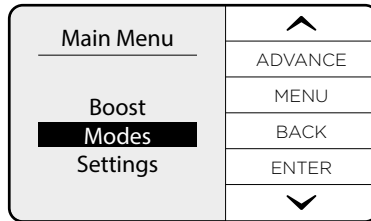
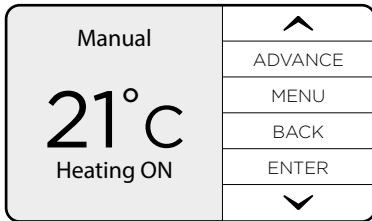

A list of Timer Modes will be shown. Their default settings are shown in the table below.

	Period 1		Period 2		Period 3		Period 4	
User Timer	06:30 - 09:30	21	11:00 - 13:00	21	15:00 - 17:00	21	18:00 - 22:00	21
Home All Day	08:00 - 21:00	21	00:00 - 00:00		00:00 - 00:00		00:00 - 00:00	
Out All Day	07:00 - 08:30	21	17:30 - 22:00	21	00:00 - 00:00		00:00 - 00:00	
Away Mode	Away Mode does not operate in the same way as the other Timers. See section 'Away Mode' on page 15							

Highlight one of the available Timer Modes using the arrow keys. Press **Enter** to select

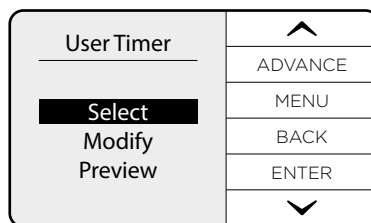
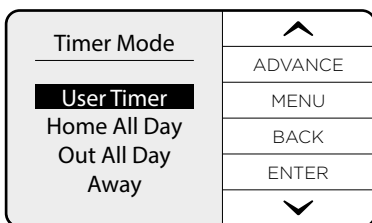

For User Timer, Home All Day and Out All Day, two choices will be available:

Select - This option will activate the timer

Modify - This option allows the timer's **Heating On** times and **Target Temperatures** to be modified

Preview - This option displays the timer's configuration. This is handy to quickly check the timer without being able to change any values

Modifying a Timer Mode

Each timer is broken down into 4 definable 'Heating On' periods and temperatures per day.

When **Modify** is chosen, 'Heating On' period 1 of 4 for the current day is displayed. The current day will be highlighted.



NOTE:
Once modified a Timer Mode must be selected if you want to begin using it.

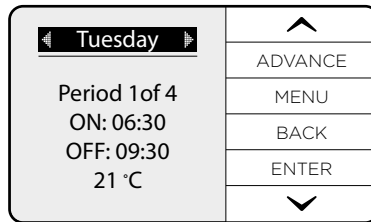
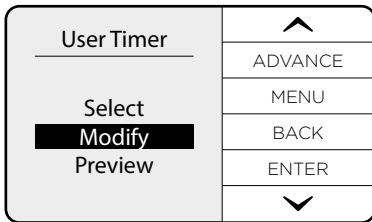

Select and change each option using the **Up**, **Down** and **Enter** buttons.

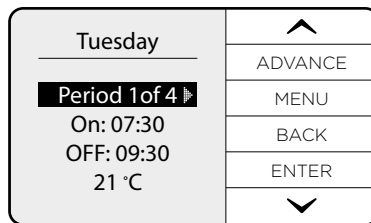
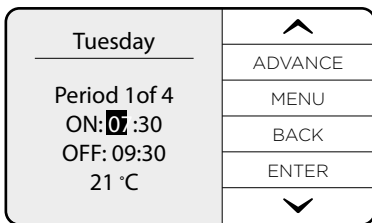

Copy & Paste

To save time when modifying a Timer Mode, the Advance button can be used to copy and paste settings.

Individual heating periods from one day or every heating period from a day can be copied to another day.

Copy time period to other days

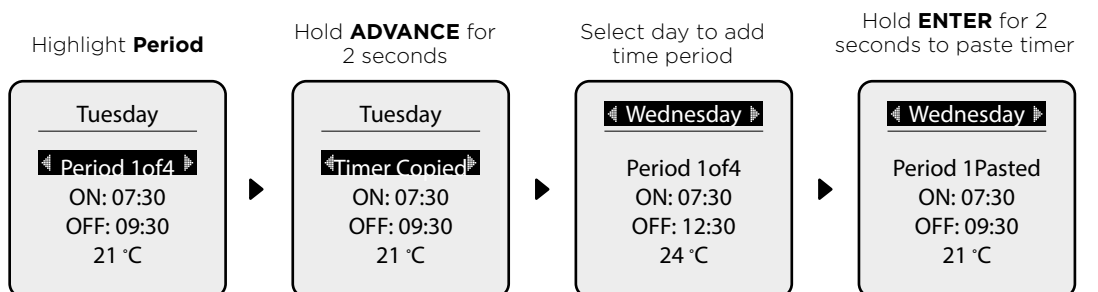

Copy all timers to multiple days

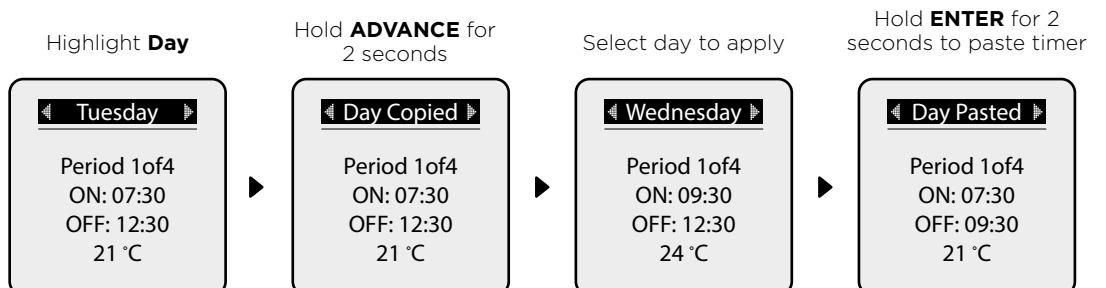

Away Mode

Away Mode temporarily overrides the active mode before returning the Heater back to the previously active mode.

This is handy if you are temporarily away at the shops or on holiday and want your heating to resume as normal operation automatically when you return.

While active, Away Mode can maintain a minimum room temperature. By default, this is set to 7 °C (frost protection temperature). This can be modified when Away mode is activated. The heater will also remember the last **Away Mode Target Temperature** defined while **Away Mode** is active.

The Away countdown is set in Time, a Date and a Target Temperature.

Date and Hours are set separately on the heater, making the feature useful for popping out to the shops or going away on holiday.

- The date set is the return date; therefore, Away mode will end at 23:59 of the day before. E.g. if a return date of 02.02.2018 is set, Away mode will end at 23:59 on 01.02.2018.
- If hours are set, this will extend away mode end from 23:59 on the day before the date set.
- If only hours and no date is set, Away Mode will count from either the current time, or if a date is set.

Timer Mode	▲
	ADVANCE
User Timer	MENU
Home All Day	BACK
Out All Day	ENTER
Away	▼

Return Date/ Time	▲
	ADVANCE
Saturday	MENU
02-2-18	BACK
07:00	ENTER
21 °C	▼

Return Date/ Time	▲
	ADVANCE
✓	MENU
Away Set	BACK
	ENTER
	▼

Away	▲
	ADVANCE
21°C	MENU
Until	BACK
31-02-18 07:00	ENTER
	▼



NOTE:

The **Back** button can be used to end the Away Mode countdown early.

Continuous Heat Modes

A Continuous Heat mode is effectively a constant **Heating On** period. The Heater will remain in a Continuous Heat mode indefinitely until the mode is changed by the User.

Available Continuous Heat Modes

Each continuous heat profile ships with a default Target Temperature value.

- Manual
 - Default 21°C
 - Can be changed from the Home Screen to any value within the range 19-30°C
- Eco
 - Default 18°C
 - Eco mode temperature can be set in the range 8-18°C
- Frost Protection
 - Default 7°C
 - Not User Definable

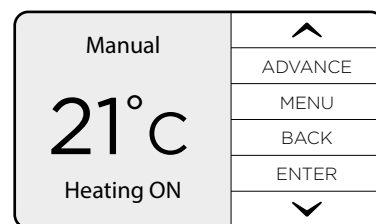
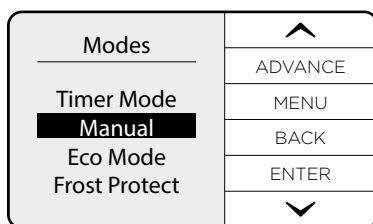

Other Functions

These functions modify the normal behaviour of the heater. They don't switch the Heater out of a Timer or Continuous Heat Mode, but can override/delay those operations, or restrict access to them.

The 'Boost' Function

Boost can be activated at any time, when the product is set to any Timer or Continuous heat mode; even if **Advance** is active This mode will provide a temporary 'Boost' of heat. For settings, see Boost settings on page 21.

Boost Mode can be activated from the Home Screen by pressing **Menu** to access the Main Menu, then pressing **Enter** to select '**Boost**'.

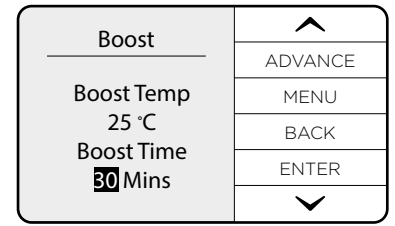
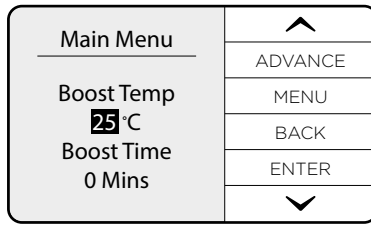
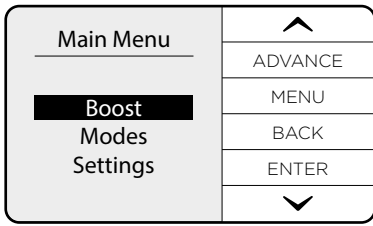

Activating Boost will present two selectable options: **Boost Temp (Boost Target Temperature)** and **Boost Time (Boost Duration Countdown)**. The default values for these can be set in the Settings Menu.

The **Up**, **Down** and **Enter** buttons can be used to modify these values. Pressing **Back** will end Boost early, restoring the heater back to its previously active mode.

- The Boost Temp can be set to any value within the Heater’s **Target Temperature Range** setting.
- The **Boost Time** can be increased in the following increments: 30 min, 1 hour, 2 hours, 3 hours, 4 hours. These increments can be restricted with the **Max. Boost Duration Range** setting. To modify this range, see Boost Settings on page 21.

Once the **Boost Duration Countdown** has reached 0, the Heater will return to the mode that was active before **Boost** was activated.

The ‘Advance’ Function

The **Advance** button is only used when a Timer Mode is active and allows the timer schedule to be changed temporarily. This button allows a **Heating On** period to begin or end early.

This is useful if you are at home when you had not planned to be, or need to leave when you had planned to have the heating on.

If the heater displays **Heating Off** and heat is required, press the **Advance** button. If the heater is in **Heating On** and heat is not required, press the **Advance** button and the heater will stop heating until the beginning of the next **Heating On** period.

Pre-action State	Action	Impact
Heating On (Timer Mode)	Advance activated	Heating On period switched to Heating Off until the next scheduled ‘Heating On’ period.
Heating Off (Timer Mode)	Advance activated	Heating Off switched to Heating On until the next scheduled ‘Heating Off’ period.
Heating On (Advance Active)	Advance deactivated	Heating On switches to Heating Off. Appliance in following schedule set in the currently active Timer Profile
Heating Off (Advance Active)	Advance deactivated	Heating Off Switches to Heating On. Appliance in following schedule set in the currently active Timer Profile

Product Locks

Product Locks are methods of locking the heater's controller to restrict access to functions. This can be activated and configured via the Advanced Settings Menu.

When Product Lock is activated, the heater continues to run in whichever mode is currently active and any/all wireless communications remain active if enabled.

Child Lock

This locking method does not utilise a PIN code and is toggled on/off on the heater's controller by pressing and holding the **Back** and **Enter** buttons for three seconds. It is a full Product lock with no exception rules.

PIN Lock

In **PIN Lock**, all UI buttons other than the **Menu** button are disabled unless **Advance** has been enabled during UI Lock (see section 'Product Lock Settings' on page 20).

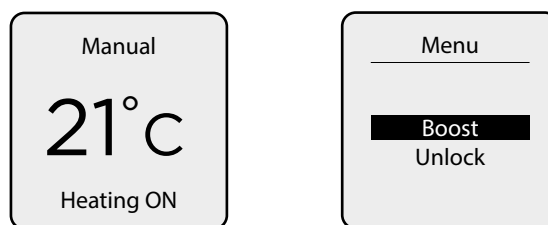

In the Main Menu all buttons are active. Two items can be selected:

Boost - Activates Boost Mode. This function can be restricted, see below.

Unlock - Selecting 'Unlock' prompts the User to complete the unlock action for the currently active.

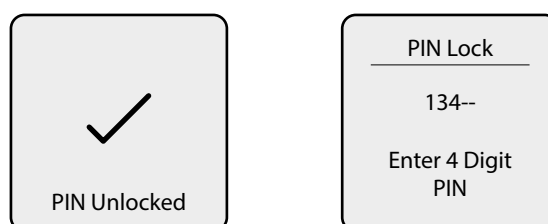

PIN Lock Exceptions

It is possible to allow the 'Advance' and 'Boost' functions to be enabled/disabled when PIN Lock is active.

There are up to 4 exceptions. These exceptions include:

- Advance

- Ability to activate using the 'Advance Button'

- Boost

- Ability to activate using the 'hotkey' listed in the Main Menu
- Ability to modify the Boost Temperature
- Ability to modify the Boost Duration

To configure these settings, see section 'Product Lock Settings' on page 20..

'Advance Function' Operation during UI Lock

If **Advance** has been enabled during UI Lock, the **Advance** button will remain active when UI Lock is active. This will function in the same way it would if the UI was not locked: only if the Heater is Locked into a Timer Mode.

- If Advance is enabled during UI lock, the **Advance** button will function as normal while the Heater is set to a Timer Mode.
- If Advance is Disabled during UI lock, the **Advance** button will not function.

'Boost Function' Operation during UI Lock

If enabled, **Boost** will function in the same way as it does when PIN Lock is not active unless modification of **Boost Temperature** and **Boost Duration** have been disabled.

Boost Temperature and **Boost Duration** will be set to the default values when 'Boost' is activated. If either of these values have been disabled during Product lock, when the user tries to modify them the heater's display will show the message 'Disabled' and only the default value can be used. The default values can be changed outside of PIN Lock.

Settings

To navigate to the settings menu, from the home screen:

Press the **Menu** button to access the Main Menu. Use the **Up / Down** buttons to highlight 'Settings', then press the **Enter** button. Each of the following headings relate to an item in the settings menu.

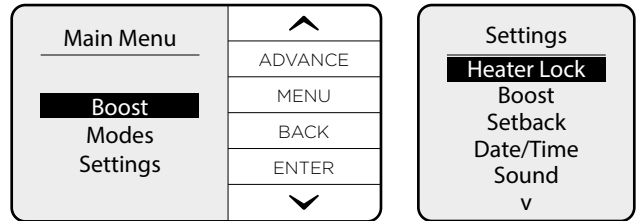

Heater Lock

Set Lock

Heater (PIN) Lock can be enabled here by highlighting 'Heater Lock' and pressing the Enter Button to enter the Heater Lock menu. Highlight 'Set Lock', press the Enter Button, enter a 4-digit PIN code, then pressing the Enter Button to lock the heater.

Lock Settings

Before UI Lock is enabled, the User can select 'Lock Settings' to enable/disable the Advance and/or Boost functions, as well as enable/disable modification of the Boost Temperature and Boost Duration. See below.

Boost Lock

Three settings can be modified within this Menu:

- Enable / Disable - The 'Boost' Menu Item can be Enabled/Disabled while PIN Lock is active.
- Temperature Rule - Modifiable Boost Temperature while Heater (PIN) Lock is active
 - Enable - While Boost is active, the User can modify this value as they normally would
 - Disable - Default value will be loaded. When the user tries to modify the value, the UI will show the following text: 'Disabled'.
- Duration Rule - Modifiable Boost Duration while Heater (PIN) Lock is active.

Advance UI Lock Settings

Enable / Disable - This setting allows the User to Enable or Disable the Advance button while Heater (PIN) Lock is active.

Boost Settings

Default Boost Target Temperature

This is the default Boost Target Temperature that is used when 'Boost Mode' is activated.

Max. Boost Duration

This is the maximum length of time that the user is able to activate 'Boost' for.

Shown in minutes (when under an hour) or hours (if over an hour) in the following increments: 30 min, 1 hour, 2 hours, 3 hours, 4 hours.

The value chosen will be the max allowed when boost is activated.

Setback Settings

Setback is a function that only modifies Timer Mode operation. When Setback is enabled it overrides any **Heating Off** period to maintain a constant temperature.

This can be used to prevent the room temperature from falling below a minimum value while there is no demand for heat (**Heating On**).

The value of this temperature is restricted to a value between 7 and 18 °C. This is because Setback should not be treated as a regular **Heating On** period.

Date & Time Settings

This allows the Time, Date and Daylight Savings Time settings to be modified.

Sound

Audio feedback when the user presses a button can be enabled or disabled here.

'Comms' (Communications)

This allows Wireless Connectivity features to be enabled or disabled.

Entering this menu item will display a list of available communications methods to that heater.

Adaptive

Open Window Detection

This is a global setting that can interrupt any active mode. Activating this setting enables **Open Window Detection** to switch the Heater to a **Heating Off** state if it detects an open window in the room it's operating in.



NOTE:

In environments where the product may read sudden decreases in temperature, this feature may activate in error. This can occur in drafty or poorly insulated environments as well as if the heater is undersized for the room. This feature should be disabled using the instructions above if activating for reasons other than the intended purpose. If you think that your environment is not as described here and this feature is activating, please contact our customer care team with the details on the rear page of this document.

Adaptive Start Setting

Adaptive Start is predictive function that only modifies Timer Mode operation. This function models the heating characteristics of the room and uses that information to pre-heat the room for only the time required to achieve the **Target Temperature** by the start of the **Heating On** period.

For example, with Adaptive Start off, the **Heating On** time is the time that the Heater will begin to try and achieve the **Target Temperature**. With **Adaptive Start** On, the Heater will begin to heat the room before the User-defined **Heating On** time so that the **Target Temperature** is achieved when the User defined the **Heating On** start time.



NOTE:

It is important that if multiple heaters are installed in one room that all heaters have the Adaptive Start (AS) function enabled. If this is not the case, heaters with AS enabled will pre-heat the room to the desired target temperature before the heaters with AS disabled attempt to output heat.

It is likely that if two heaters are required in one room, that the output from one heater may not be sufficient to heat the room alone. This may cause the pre-heat time calculation to extend to a large degree if the heaters do not all have AS enabled. This may lead to heat at unwanted times and excessive wear to some heaters.

A two-hour limit is enforced on the calculation, however, if all heaters have AS enabled and pre-heating takes over one-hour, extreme environmental factors may be affecting the calculation or the heaters may be under sized for the room. Please contact us for support if your pre-heat time seems excessive.



NOTE:

This is a continuously learning function and will be affected daily by changes in the heater's environment. The heater will take into account the starting temperature of the room so pre-heating should remain accurate.

Advanced Settings

These settings can be used to significantly change the operation of the heater. While useful for very specific requirements, there is a much higher risk of User error and unintended consequences of changing these settings compared to the top-level settings menu. It is recommended that these settings are only modified by trained professionals.

To navigate to the Advanced settings menu, from the home screen:
Press and hold the Advance and Menu buttons for 3 seconds.

Each of the following headings relate to an item in the settings menu.

Temperature Settings

Temp Units (Temperature Units)

This setting defines which temperature units are displayed on the heater. The default is °C, but °F can be set. When °F is selected, the heater will convert °C values to °F and round to the nearest number.

Service (Service Settings)

These items are for use by service personnel only. The settings effect the effect the accuracy and energy usage of the heater and should only be modified by a professional.

Room Temp (Temperature) Offset

Allows the manual adjustment of electronic thermostat reading by +/-3.0°C

Factory Reset

This setting allows the User to restore the default values to all settings. Returning the product to the same state that it left the factory.

Error Codes

Error codes are to be defined as a list. Each error code must be defined as a perimeter that Central Control can read.

Fault Code Parameter	Comment	Error Code
Thermistor Failures		
FAULT_CODE_THERMISTOR_FAILURE	Room thermistor error	20
FAULT_CODE_ROOM_THERMISTOR_FAILURE		n/a
FAULT_CODE_CORE_THERMISTOR_FAILURE		n/a
FAULT_CODE_LCD_THERMISTOR_FAILURE		22
FAULT_CODE_ACC_THERMISTOR_FAILURE		n/a
FAULT_CODE_FAN_THERMISTOR_FAILURE		n/a
Excessive temperatures		
FAULT_CODE_EXCESSIVEROOMTEMP_FAILURE		30
FAULT_CODE_LCD_OVERHEAT		32
FAULT_CODE_EXCESSIVEACCTEMP_FAILURE		n/a
FAULT_CODE_FAN_FAILURE		n/a
Internal Failures		
FAULT_CODE_SERIAL_COMM		40
FAULT_CODE_ELEMENT_FAILURE	low current measurement	41
User related errors		
FAULT_CODE_OPENWINDOWDETECTION_FAILURE		50
FAULT_CODE_LOW_WATER		n/a
FAULT_CODE_HEAT_DISABLED		n/a
FAULT_CODE_TIMELOSS_FAILURE		53
FAULT_CODE_OCCUPANCYSENSORNOTDETECTED_FAILURE		54
FAULT_CODE_OTHER_ERROR		n/a
IoT related errors		
FAULT_CODE_WIRELESSCOMM_FAILURE	error between heater and RF module	60
FAULT_CODE_GATEWAYCOMM_FAILURE		61

Battery Replacement

IMPORTANT: Before replacing the battery ensure the heater is isolated from the electricity supply. **NOTE - Battery should be disposed of in an appropriate manner**

This product is fitted with a replaceable battery in the controls.

To replace the battery, follow the steps below, shown in **Fig. 6**:

1. Unhinge the heater from the wall using the clips shown in **Fig. 2** and locate the battery module.
2. Slide the catch and pull module from the controls.
3. Remove the coin cell battery and replace.
4. Slide module back in place, ensuring clip is engaged.

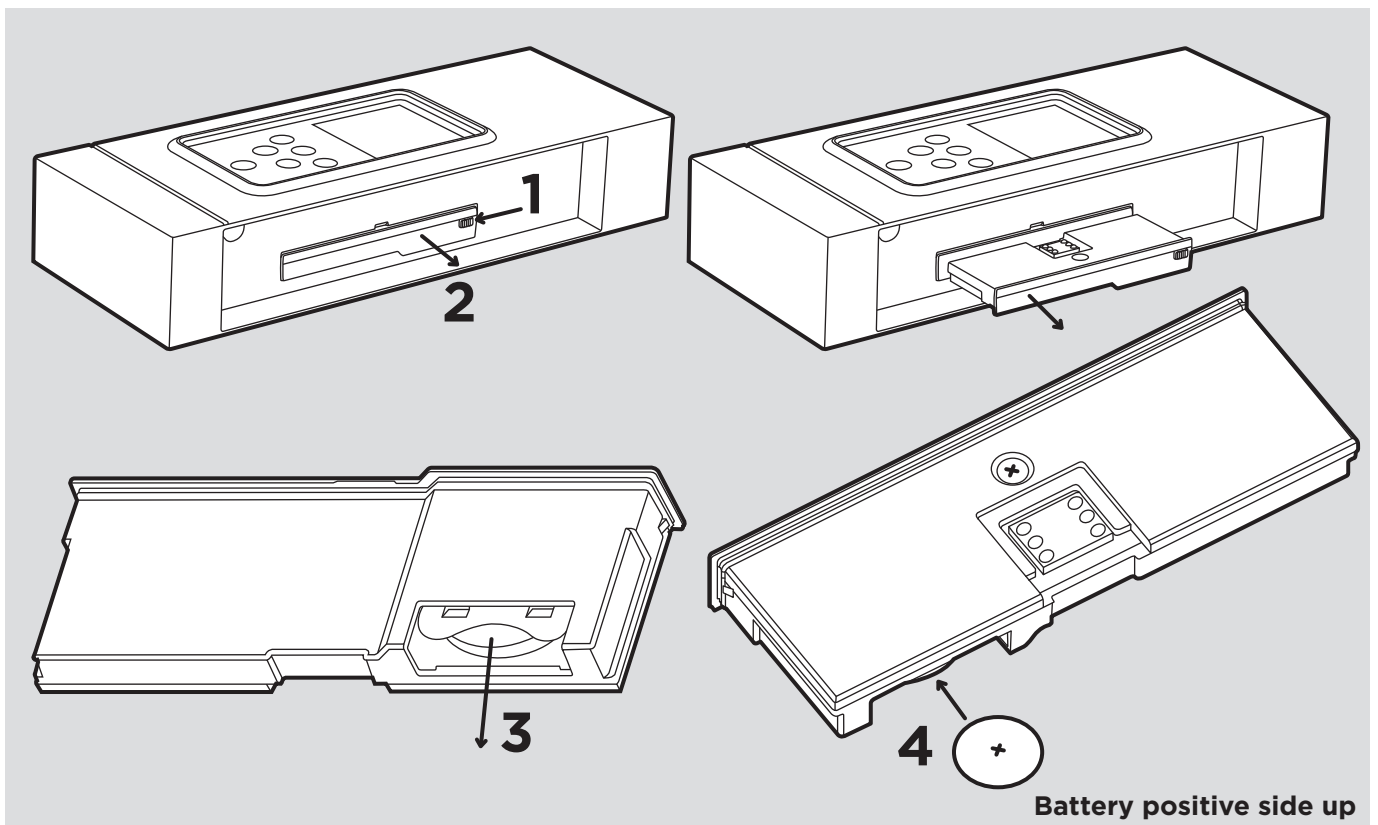

RF Module Installation

1. Unhinge the heater from the wall using the clips shown in Fig. 2 (page 8) and locate the battery module, indicated in Fig. 5
2. Slide the catch and pull module from the controls (See Fig 5; 1-3).
3. Replace the tray with the radio frequency module
4. Power the product on and make sure that the RF comms are enabled. Comms settings will be located in the settings menu (see page 21)

Important

During the initial operation, some odour may be noticed due to the newness of materials used in manufacture. This is normal and will disappear after a short period of use. It is however advisable to keep the room well ventilated

Cleaning

WARNING - ALWAYS DISCONNECT FROM THE POWER SUPPLY BEFORE CLEANING THE HEATER.

Before commencing cleaning, isolate the heater from the electrical supply and allow it to cool. The outside can be cleaned by wiping it over with a soft dry cloth. Do not use abrasive cleaning powders or furniture polish, as this can damage the surface finish. To release the heater from the wall bracket for cleaning or redecoration, depress the latch on both brackets (See **Fig. 2, page 8**) and hinge forward.

Recycling



For electrical products sold within the European Community. At the end of the electrical product's useful life it should not be disposed of with household waste. Please recycle where facilities exist. Check with your Local Authority or retailer for recycling advice in your country. Batteries should be disposed of or recycled in accordance with WEEE Directive 2012/19/EU. Packaging should be recycled where possible.

Dimplex · Control

This product is Dimplex Control capable * **.

Control and monitor your heating and hot water with Dimplex Control. Group heaters into zones to easily control and track their energy usage. Any time. Anywhere

Search for Dimplex Control on your device's app store.



*Requires additional hardware. Sold separately. Visit Dimplex.co.uk for more information.

**A Dimplex Hub and RFM are required for this product to connect to Dimplex Control.

Your Guarantee



To view the full guarantee terms and conditions scan this QR code using your smartphone or go to <https://www.gdhv.co.uk/guarantee-terms-and-conditions>.

Your Product is manufactured by Glen Dimplex UK operating as Glen Dimplex Heating & Ventilation. GDHV designs and manufactures products to ensure they deliver reliable service for normal use in domestic dwellings and, where specified by us, in light commercial premises.

GDHV products are individually tested before leaving the factory, Your product comes with a 2 year parts and labour guarantee for repair or replacement of faulty goods and/or partial refund in the event that a repair or replacement is not available.

Your guarantee is provided by Glen Dimplex UK Ltd operating as Glen Dimplex Heating & Ventilation Ltd, Millbrook House, Grange Drive, Southampton SO30 2DF. Terms and conditions apply.

The GDHV guarantee does not in any way diminish or affect your statutory consumer rights in connection with your product.

If you experience a problem with your product during or after the guarantee period, visit our online help centre:

<https://www.dimplex.co.uk/gdhv-help-centre>

If you cannot solve your issue online, contact the customer care team on 0344 879 3588

Please note that when you contact us you will need to provide the model and serial number of your product and a description of the fault which has occurred.

Register



IMPORTANT: Please register your product without delay.

Simply scan this QR code using your smartphone, or go to

<https://www.dimplex.co.uk/register>.

If you do not have access to the internet, please call us on 0344 879 3588

Why Register Your Products With Us?



Faster Customer Service

Once you have registered your product, our customer service team will be able to quickly access your details when you contact us, allowing them to help you sooner.



Guarantee Management

Upon registration, you will receive a confirmation email including a summary of your product guarantee, a copy of our terms and conditions and a copy of your proof of purchase (optional).



Product Recall Notification

If your product is registered you will automatically be contacted with applicable safety notifications, or in the unlikely event of a product recall.

Please register your product with us within 28 days of date of purchase to enable us to provide efficient customer service if you need to contact us, to contact you in the event of a product or safety update, to extend your guarantee where applicable, and, if you choose, to send you additional information about our products and services.

Register your product at <https://www.gdhv.co.uk/register>, or if you do not have access to the internet, call us on 0344 879 3588.

On registering you will automatically receive a copy of the terms and conditions of your guarantee, which can also be downloaded at any time from <https://www.gdhv.co.uk/guarantee-terms-and-conditions>. If you do not have access to the internet, call us on 0344 879 3588 and we will send them to you by post.

Customer Helpline: 0344 879 3588
gdhv.customersupport@glendimplex.co.uk
www.dimplex.co.uk



Glen Dimplex Heating & Ventilation
Millbrook House, Grange Drive, Hedge End, Southampton, SO30 2DF

Glen Dimplex Europe, Airport Road, Cloghran, Co. Dublin K67 VE08



© Glen Dimplex. All rights reserved. Material contained in this publication may not be reproduced in whole or in part, without prior permission in writing of Glen Dimplex.