



Read these instructions before commencing installation. Please give these instructions to the owner/occupier after installation to retain for future reference/maintenance.

IP65 240V~50Hz 5W, 7W & 9W

These fittings are Class II and do not require to be Earthed

Important Information

It is recommended that these luminaires are installed and fitted by a qualified electrician ensuring the installation complies with current IEE wiring regulations & local building control. These products are designed for connection to a 240V~50Hz supply.

Any faulty, broken or damaged luminaires should be replaced immediately.

KSR will not accept responsibility for any claims arising from a poor installation.

Please Note: The limited warranty shall be deemed null and void in the following circumstances:

Failure by the installer, end user or any third party to exercise caution to protect any covered product or part from outside damage, adverse temperature (normal operating ambient temperature -10 ~ +35°C), humidity conditions, fluctuations in the electrical system or physical abuse as well as failure related to workmanship in the installation of the products or parts.

Important User Advice

Always safely isolate the mains supply before installing/servicing.

This luminaire should not be fitted to damp or wet surfaces such as freshly plastered or painted ceilings.

Do not use Megger or similar high voltage instruments without first switching the isolation switch on the driver. To prevent damage to the driver, do not mix with conventional magnetic ballasts on the same electrical circuit. At the end of life the luminaire is classed as WEEE under directive 2014/30/EU and should be disposed of in accordance with local legislation.

Installation Procedure

KSR recommends that a sample hole is cut in some scrap material to familiarise yourself with the installation. Once you are completely satisfied: Locate the area's suitable to install these luminaires. Cut a 74mm round hole in the ceiling and ensure sufficient ceiling void (Fig.1) without infringing on joists, water pipes or electrical cables.

Connect the mains supply to the LED Driver (Blue - Neutral, Brown - Live). Earth terminals are provided for earth continuity only. Press into place the strain relief end cap by pushing down until it grips the outer cable insulation. The LED driver allows for mains loop in/loop out connections, if not looping through either of the L,E & N inputs can be used.

(Fig.2) Select the preferred colour temperature by sliding the selector switch located on the head to either 2700K, 3000K, 4000K or 6000K. This must be done before the power is switched on to the luminaire, changing the CCT while the fitting is illuminated may damage the LED. Secondly select the preferred power output on located on the LED driver 5W, 7W and 9W.

Press springs back and push luminaire body into aperture.

If you are installing one of the KSR detachable rims remove the standard white rim by twisting the rim anticlockwise, remove the LED module from the rim clockwise. Fit the new rim is reversal of removal.

Important note: This downlight can not be covered with mineral wool insulation, the head unit and driver should remain in free air space to avoid overheating.

(Fig.3) **This downlight is designed with an Isolator switch to allow for High voltage insulation resistance testing, without having to remove the luminaire/driver from the circuit.**

**Please note: Depending on the amount of Qr10 fittings on a circuit you may have to upgrade the breaker to a 'C' or 'D' type due to the way electronic LED drivers start up with higher inrush currents compared to halogen lighting. If dimming, see the recommended dimmers list at www.ksrlighting.com or for any other questions please call our sales office on 023 92 674343.*

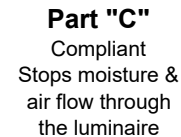

Available Rim Finishes:
White, Chrome,
Satin Chrome or Black

Fig. 1 74mm
90mm min. void depth

WARNING:
Do not change the CCT or drive current of this downlight with the product switched on, all changes must be done with the power off.

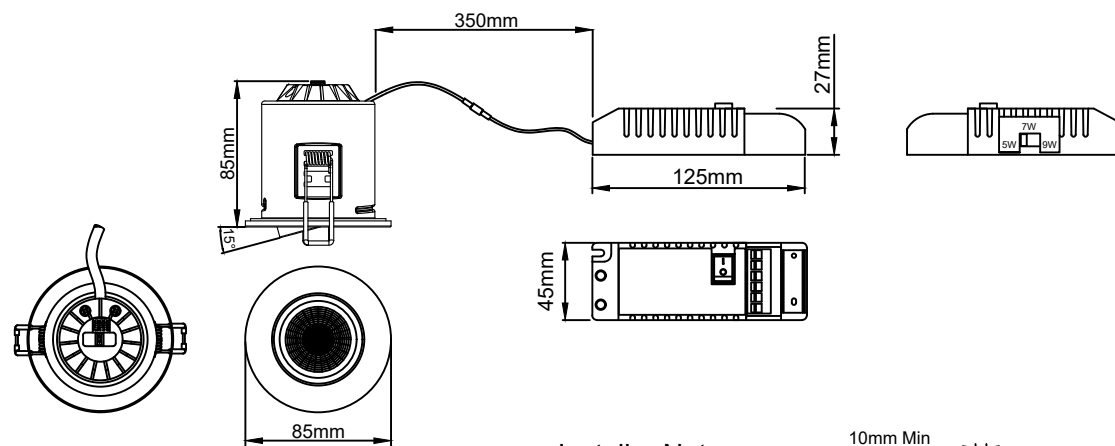
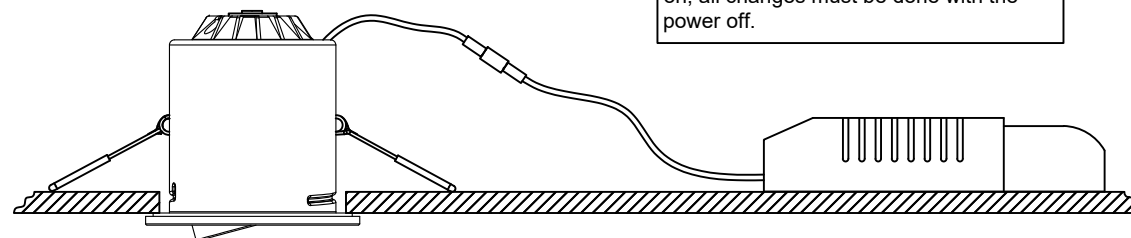

ØRim Size	ØCut out	Void Depth Req'd	Max per circuit
85mm	74mm	90mm	20

Installer Note:

To ensure a good connection strip back a minimum of 10mm insulation and push the cable firmly into the terminal block.

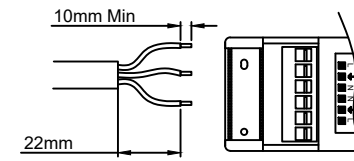

This product contains a light source of energy efficiency class F



KSR Lighting Aftersales: 023 92 674343
E-mail: aftersales@ksrlighting.com



Read these instructions before commencing installation. Please give these instructions to the owner/occupier after installation to retain for future reference/maintenance.

IP65 240V~50Hz 5W, 7W & 9W

Part "B"



BS476 Part 21

Part "E"

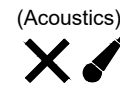

(Acoustics)

Part "C"

Compliant
Stops moisture & air flow through the luminaire

Available Rim Finishes:

White, Chrome,
Satin Chrome or Black

WARNING:

Do not change the CCT or drive current of this downlight with the product switched on, all changes must be done with the power off.

Fig. 2

Colour Temperature Selector Switch

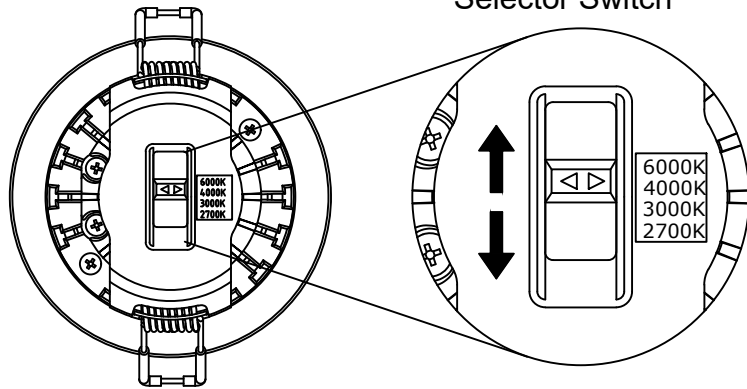

Rim Size	Cut out	Void Depth Required	Beam Angle	Dimmable	CCT	Lumen output per head		
						5W	7W	9W
85mm	74mm	90mm	58°	Yes	2700K	535lm	700lm	820lm
					3000K	540lm	720lm	845lm
					4000K	580lm	785lm	930lm
					6000K	590lm	775lm	910lm

Fig. 3

Isolator Switch
Isolates device from Circuit

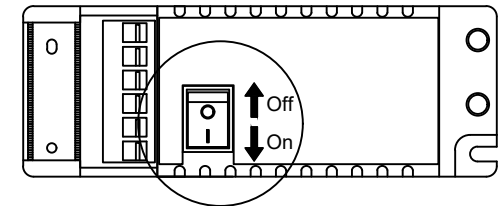

Drive Current Selector Switch

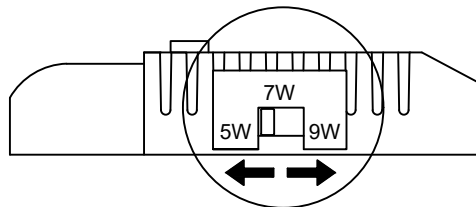

Please Note: The isolation switch needs to be in the On (I) position during normal operation



KSR Lighting Aftersales: 023 92 674343
E-mail: aftersales@ksrlighting.com