

# LEDLITE™ User Instructions

## 60W Stainless Steel PIR Wall Light LTSSWL1PIR

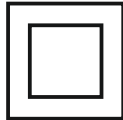

220-240V  
50Hz



Please read these instructions and retain them for future reference.

### Important information

It is recommended that the fittings are installed by a qualified electrician ensuring the installation complies with current IEE wiring regulations & local building control.

- These products are designed for connection to a 220-240V mains supply.
- We cannot accept responsibility for any claims arising from a poor installation.

Never fit bulbs of a higher wattage or of a type other than those specified on the label as this may cause overheating and damage the fitting.

### Important User Advice

- Always switch off mains supply before installation.
- The entire fitting gets hot whilst on for a period of time.
- The light fitting is Class II and does not require an earth connection.

### Dimensions:

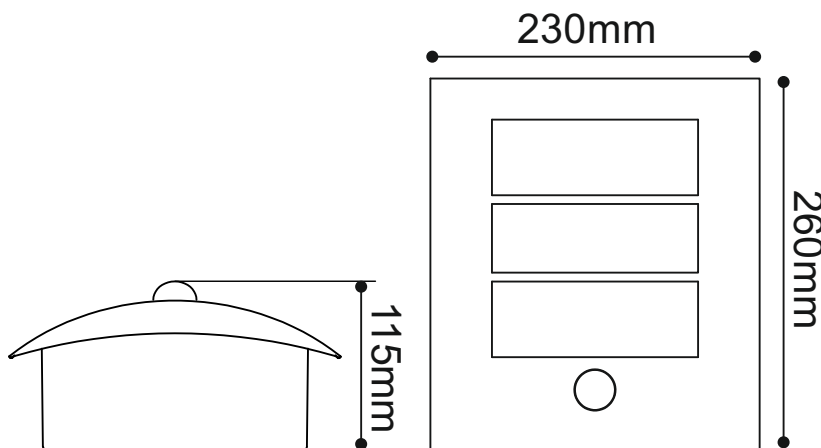

### Specifications:

- Voltage: 220-240V/AC
- Frequency: 50/60Hz
- Max Load (ES/E27 Lampholder):
  - Incandescent: 60W
  - Fluorescent: 20W CFL
  - LED: 3-10W
- IP Rating: IP44
- Detection Angle: <math><90^\circ</math>
- Detection Range: 7m (Max)
- Time setting - min: 10sec $\pm$ 3sec  
- max: 5min $\pm$ 1min
- Lux Level: Dusk to Dawn (adjustable)
- Installation height: 1.5m~2.5m

### Before you start the installation

- **Make sure that there are no pipes or cables beneath the mounting surface.**
- Check the packaging and make sure that you have all the required parts.
- Follow each assembly step in order to prevent incorrect assembly.
- Make sure all screws / nuts, including electrical connections etc are fully tightened before use.
- Avoid aiming the motion sensor at pools, heating vents, air conditioners or objects that may change temperature rapidly.
- Try to avoid pointing the unit at trees or shrubs or where the motion of pets may be detected.

### Tools required:



Pencil

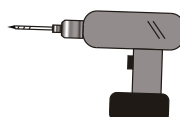

Electric drill

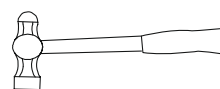

Hammer



Screwdriver

# Installation

**Step 1:** Switch off mains supply (A).

**Step 2:** Unscrew the two back screws (B) and remove the stainless steel plate.

**Step 3:** Identify the location and direction of any hidden supply cables or service pipes before drilling fixing holes. Hold the fitting in place and mark the position of the fixing holes. Ensure that the fitting is even and the wall is capable of holding the weight of the product.

**Step 4:** Pull the supply wires through the rubber grommet inside the fitting and fix the fitting to the wall using the screws and plugs (C).

**Step 5: Wiring** - Connect the supply wires to the connection block inside the fitting in the following way (D):

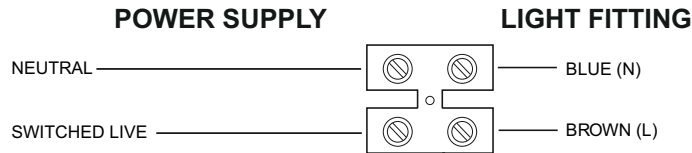

**Step 6: Fitting/Replacing the lamp** - Fit the E27 base lamp inside making sure not to exceed the wattage indicated on the fitting (E).

When replacing the lamp always allow time for it to cool before handling.

Dispose of the used lamp carefully.

**Step 7:** Fix the stainless steel plate by screwing back the two back screws (E).

**Step 8:** Power up the fitting to check if it functions correctly(F).

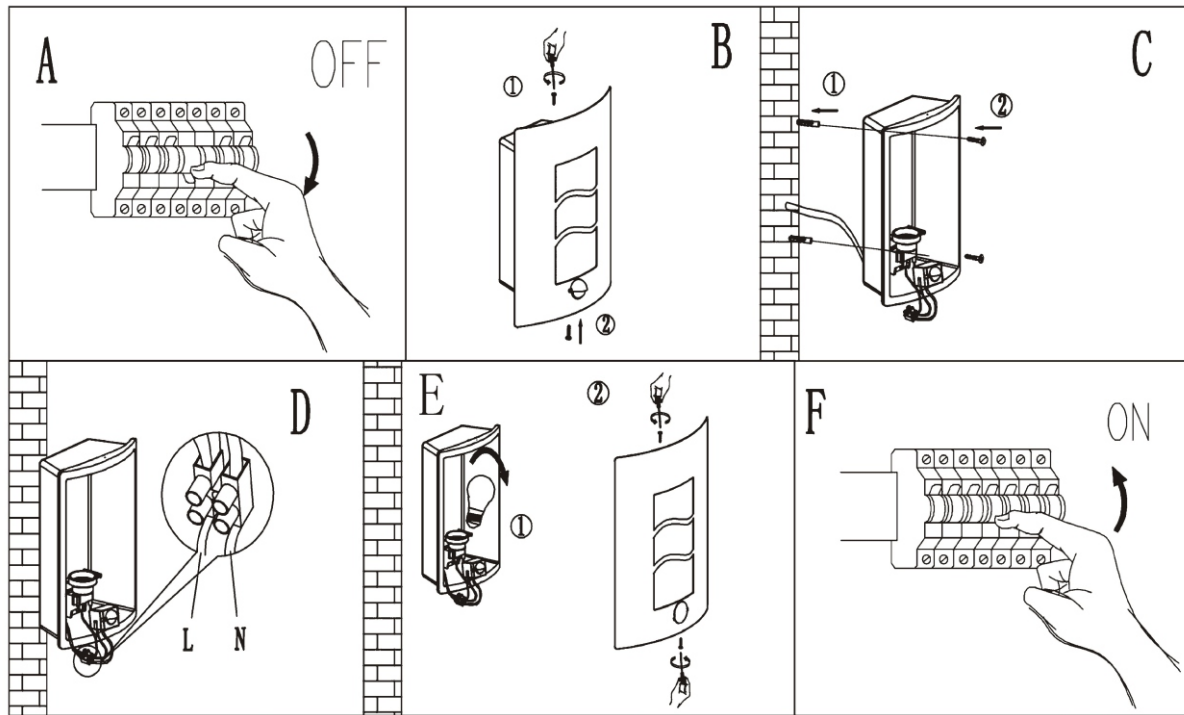

# PIR Adjustment

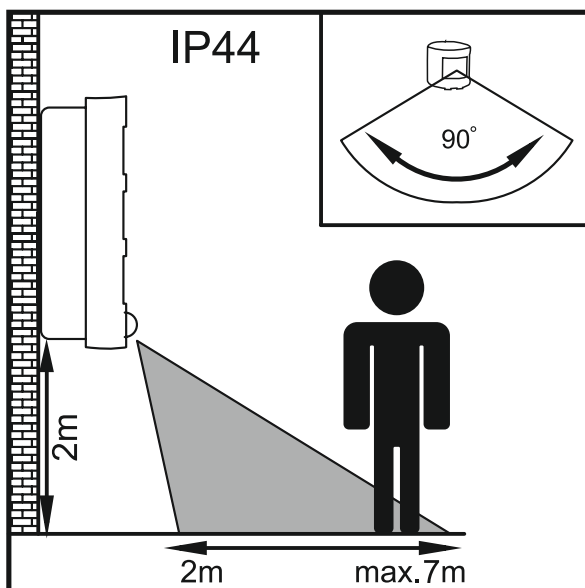

The unit must be installed in vertical position and fitted 1.5m-2.5m above the ground.

The detection range is fixed to a maximum of 7 metres.

### TIME ADJUSTMENT

Turn the time control knob clockwise to increase (up to about 5 minutes) how long light stays on or anti-clockwise to decrease (down to about 10 seconds) the time delay.

### LUX ADJUSTMENT

Turn the LUX control knob clockwise (+) and the sensor will be active all day. Turn the knob anti-clockwise at (-) (dusk) position and the motion sensor remains inactive during daylight.

At dusk when the light level is at the LUX required, simply set the LUX control knob to the position where the motion sensor will become active as daylight declines.