

TIMEGUARD®

360° Flush Mount PIR Light Controller

Model: SLFM360N



Installation & Operating Instructions

1. General Information

These instructions should be read carefully and retained for further reference and maintenance.

2. Safety

- Before installation or maintenance, ensure the mains supply to the PIR sensor is switched off and the circuit supply fuses are removed or the circuit breaker turned off.
- It is recommended that a qualified electrician is consulted or employed for the installation of this PIR sensor and that it is installed in accordance with current IEE wiring and Building Regulations.
- Check that the total load on the circuit including when this PIR sensor is fitted does not exceed the rating of the circuit cable, fuse or circuit breaker.
- Secure device with 10A rated air breaker.

3. Technical Specifications

- 230V AC 50Hz
- This PIR sensor is of class II construction and must not be earthed
- Motion Detection Range: Up to 8 meters diameter at a 3m mounting height
- Presence Detection Range: Up to an 4 metres diameter at a 3m mounting height
- Detection Angle: 360°
- Maximum Switching Load: 2300W Halogen lighting, 500W Fluorescent lighting, 500W LED lighting, (PF>0.9), 75W Fan.
- Time ON Adjustment: 3 seconds to 18 minutes.
- Dusk Level Adjustment: Day & Night or Night-time only operation (1 to 1000 Lux).
- Manual Override: Pulse, for approximately 6 hours ON time max.
- Ceiling Cut-out: Requires a 75mm diameter ceiling cut-out
- IP44 Rated, suitable for restricted internal applications

- CE Compliant
- Dimensions (H x W x D): 90 x 90 x 60mm
- Multiple PIR Sensor Switching: A maximum of 8 SLFM360N PIR sensors can be wired in parallel, to enable any detector to turn ON all the lights connected. The total load must not exceed the lamp rating of a single SLFM360N unit.

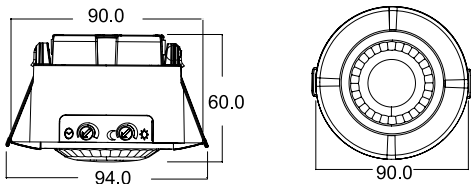

2

4. Selecting a Location

- The motion detector has a number of detection zones, at various vertical and horizontal angles as shown (See diagram "A").
- The best all-round coverage is achieved with the unit mounted at the optimum height of 3 metres.
- Careful positioning of the sensor will be required to ensure optimum performance (see diagrams "A" & "B" detailing detection range and direction).
- The sensor is more sensitive to movement ACROSS its field of vision than to movement directly TOWARDS IT (see diagram "B"). Therefore position the unit so that the sensor looks ACROSS the likely approach path.
- Avoid positioning the sensor where there are any sources of heat in the detection area (fans, radiators, heaters etc.) including opposite any other light sources.
- Reflective surfaces (i.e. white-painted walls, windows) may cause false activation.

Diagram A

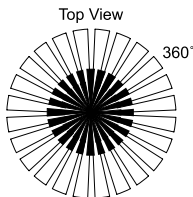
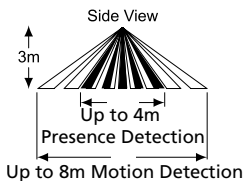
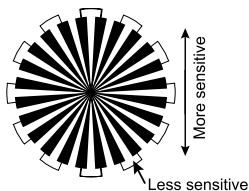

Diagram B



3

5. Installation

- Ensure the mains supply is switched off and the circuit supply fuses are removed or the circuit breaker turned off.
- An isolating switch should be installed to enable the power to be switched ON & OFF for maintenance purposes and to activate the manual/auto override function.
- Remove the wiring cover from the sensor by depressing the catch on the side and lifting it clear of the twin locators opposite the catch.
- Remove both cable clamps from the sensor body by undoing the 4 cable clamp screws.
- Mark the position of the 75mm diameter fixing hole centre, taking care to avoid ceiling joists and other obstructions within the 75mm diameter.
- Using a pad saw or suitable hole cutter cut out a 75mm diameter hole.
- Pass the 230V 50Hz mains supply and load cables through the hole and prepare for termination.
- Terminate the cables into the terminal block, ensuring correct polarity is observed and that all bare conductors are sleeved (see section 6. Connection Diagram).

- The adjustment knobs located beneath the sensor head are factory-set to "Test Mode". Double check they are set as follows;

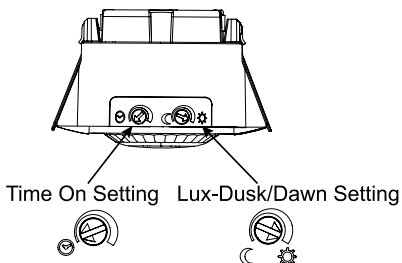

- Replace both cable clamps previously removed, using the 4 cable clamp screws, to secure the mains supply and load cables to the sensor. Do not overtighten the screws.

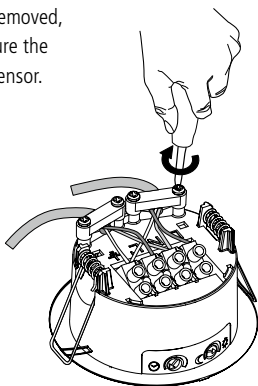
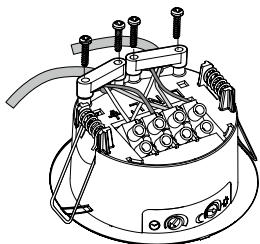

- Reposition the wiring cover onto the sensor and click into place.

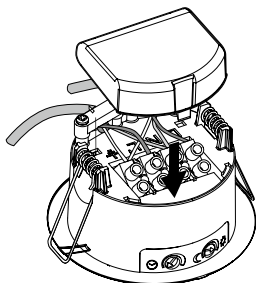

- Push back the locating springs and feed the unit into the ceiling void via the 75mm hole. The locating springs will now fold back and hold the SLFM360N in place.

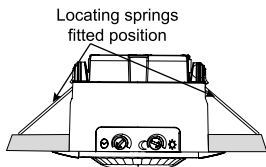
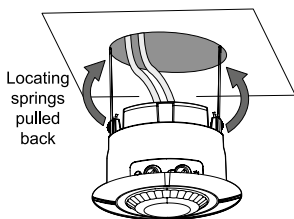

6. Connection Diagram

- Connect the cables as follows;

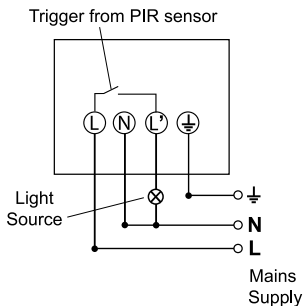
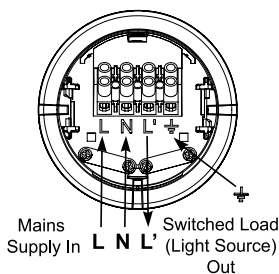

230V 50Hz Mains Supply

Live Supply (Brown or Red) to

L

Neutral Supply (Blue or Black) to

N

A 'Loop Terminal' is provided should a 3 core cable be used which is marked



Switched Load (Light Source) Out

Switch Live (Brown or Red) to

L1

Neutral Load (Blue or Black) to

N

7. Setting Up

Walk Test (Test Mode)

- Turn the power to the unit ON. The lamp will immediately illuminate as the unit goes through its “warm-up” period. After approximately 45 seconds the lamp will extinguish. This indicates the unit is wired correctly and the unit is in Test Mode.
- Try to remain outside the detection area during the warm-up period.
- The unit will now operate during daytime as well as at night, illuminating the lamp for approx. 3 seconds each time. This allows testing to be carried out to establish whether the sensor is covering the required area.
- Walk around the sensor to establish the detection area. The sensor will detect within an approximate 8 metre diameter circle from the centre of the sensor location with a 3m ceiling. As you cross a detection “zone” the lamp will illuminate.
- Now stand still until the lamp extinguishes (this should take approx. 3 seconds). Start moving again after 2 seconds. As you cross each “zone” the lamp will illuminate.
- Repeat the above, walking at various distances and angles to the unit. This will help you to confirm the detection pattern.

8. Setting Up for Automatic Operation (Auto Mode)

- When the walk tests are complete, the unit can be adjusted for automatic operation.
- The Time Setting controls how long the unit remains illuminated following activation and after all motion ceases.
- The minimum time (fully anticlockwise) is approx. 3 seconds, whilst the maximum time (fully clockwise) is approx. 18 minutes. Set the control to the desired setting between these limits.
- The Lux-Dusk/Dawn Setting determines the level of darkness required for the unit to start operating. The setting is best achieved through the procedure below;
 1. Set the Lux-Dusk/Dawn Setting control knob fully anticlockwise.
 2. When the ambient light level reaches the level of darkness at which you wish the lamp to become operative (i.e. at dusk) SLOWLY rotate the control in a clockwise direction until a point is reached where the lamp illuminates.
 3. Leave the control set at this point.
 - At this position the unit should become operational at approximately the same level of darkness each evening.
 - Observe the operation of the unit. If the unit is starting to operate too early (i.e. when it is quite light) adjust the control slightly anticlockwise. If the unit starts to operate too late (i.e. when it is very dark) adjust the control slightly clockwise.
 - Continue to adjust until the unit operates as desired.

9. Manual Override Mode

The light can be switched ON for longer time periods through use of the Manual Override Mode. This can be activated at night by using the isolation switch.

- Activate the isolation switch once (OFF/ON) within 1.5 seconds.
- The unit will now illuminate continuously for 6 hours or until it is switched back to Auto Mode.
- To return to Auto Mode turn the isolation switch OFF and then back ON again within 1.5 seconds.

10. Troubleshooting

Problem

Solution

- The Lamp stays ON all the time at night. Cover the PIR lens with a thick cloth. If the light turns OFF, check the detection area for heat or a reflective source. If the light stays ON, check the wiring (see section 5. Installation and Connection).
- The PIR keeps activating for no reason at random. Turn OFF at the isolation switch. Turn back ON again after 30 seconds. Leave for approximately 15 minutes. If the light activates, check for false activation from heat, wind or a reflective source.
- PIR sensor will not operate at all. Check that the power is switched ON at the isolation switch. Turn OFF the power to the unit and check the wiring connections. Check the lamp (if it's changeable). If the lamp has failed, replace. Ensure the lamp is seated correctly in the lamp-holder. Note: the unit will not detect through glass (e.g. in a glazed porch).
- PIR sensor will not operate at night. The level of ambient light in the area may be too bright to allow operation at the current DUSK setting. During the hours of darkness, adjust the DUSK control slowly clockwise until the lamp illuminates.
- PIR activates during the daytime. Adjust the DUSK control setting anti-clockwise to lower the level of ambient light required for activation.

- PIR coverage is poor/sporadic
The PIR may be poorly located. See section 4. Selecting a location and relocate the unit.
- The detection range varies from day to day.
The PIR detectors are influenced by climatic conditions. The colder the ambient temperature, the more effective the sensor will be. You may need to make seasonal adjustments to the detector head position to ensure trouble-free operation all year round.

3 Year Guarantee

In the unlikely event of this product becoming faulty due to defective material or manufacture within 3 years of the date of purchase, please return it to your supplier in the first year with proof of purchase and it will be replaced free of charge. For years 2 and 3 or any difficulty in the first year, telephone the helpline on 020 8450 0515.

Note: A proof of purchase is required in all cases. For all eligible replacements (where agreed by Timeguard) the customer is responsible for all shipping/postage charges outside of the UK. All shipping costs are to be paid in advance before a replacement is sent.



If you experience problems, do not immediately
return the unit to the store.

Telephone the Timeguard Customer Helpline;

HELPLINE

020 8450 0515

or email helpline@timeguard.com

Qualified Customer Support Coordinators will be online
to assist in resolving your query.



A **theben** Group Company

For a product brochure please contact:

Timeguard Limited.

Victory Park, 400 Edgware Road,

London NW2 6ND

Sales Office: 020 8452 1112

or email csc@timeguard.com

www.timeguard.com