

UK WIRE BASKET CATALOGUE

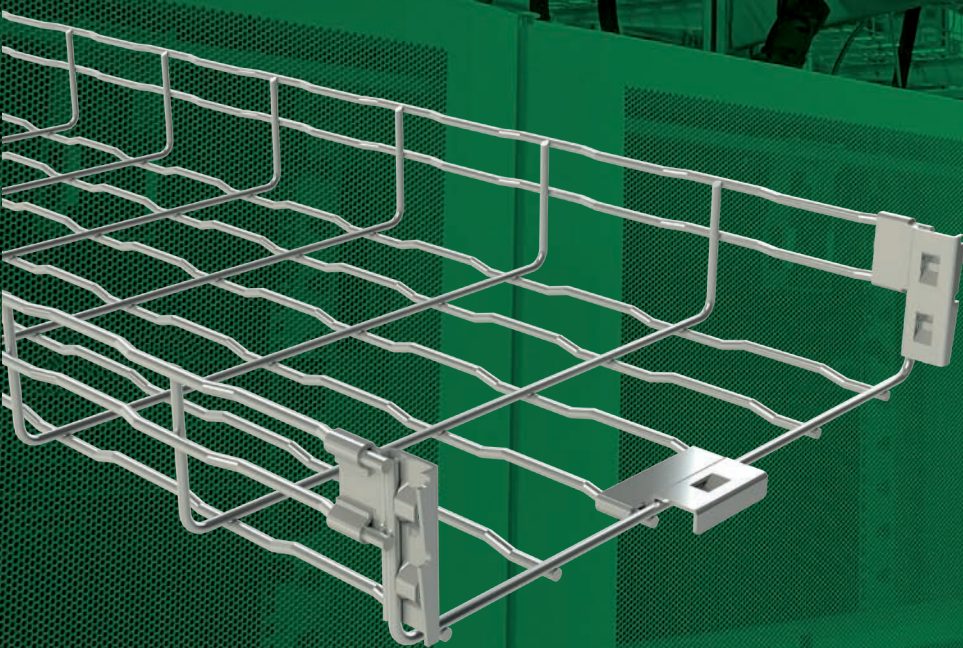

DIETZEL
UNIVOLT

3E Basor
CABLE TRAY SPECIALIST

CABLE MANAGEMENT ALLIANCE

SUMMARY

BASORFIL
Wire Basket.....Page.3

OTHER PRODUCTS
Metal & PVC Cable trays.....Page.15

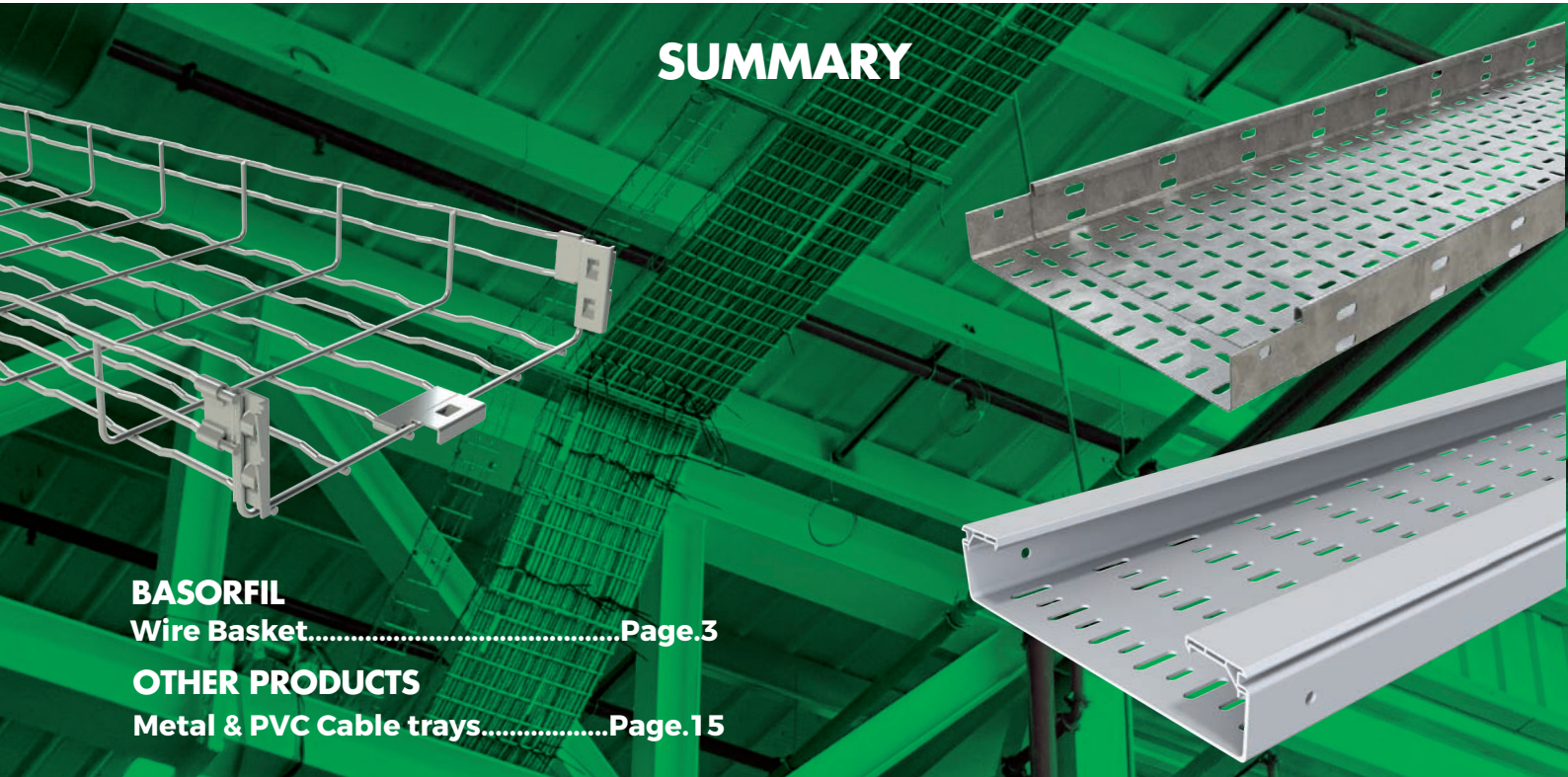

BF2R

ASSEMBLY IN STEPS 2

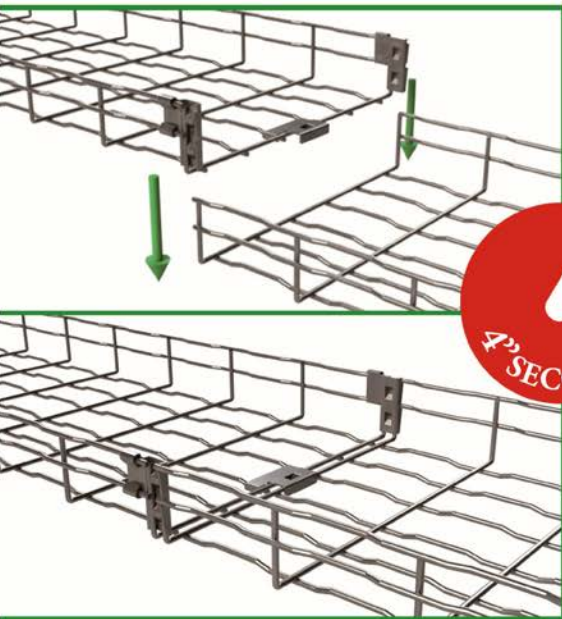

The fast fix self-couplers gives a strong rigidity across the joints, whilst meeting and exceeding BSEN61537:2007 standard for electrical continuity.



The fast fix self-couplers attached to the end of the Wire Basket are used as a guide, and can be secured within seconds, therefore saving time and money to the installer.



Univolt Wire Basket lengths can be installed upto 78% faster than traditional Wire Baskets, making Univolt the ideal solution for new Data and Distribution Centres.



Contact Us

Mail: sales@univolt.co.uk
Phone: 01707379820

APPROVED BY:



APPLICATIONS

**DATA
CENTER**

**FOOD
INDUSTRY**

**INDUSTRIAL
INFRASTRUCTURES**

**COMMERCIAL
BUILDINGS**

**RENEWABLE
ENERGY**



Self-coupling
BASKET TRAYS

Basorfil Basket Trays

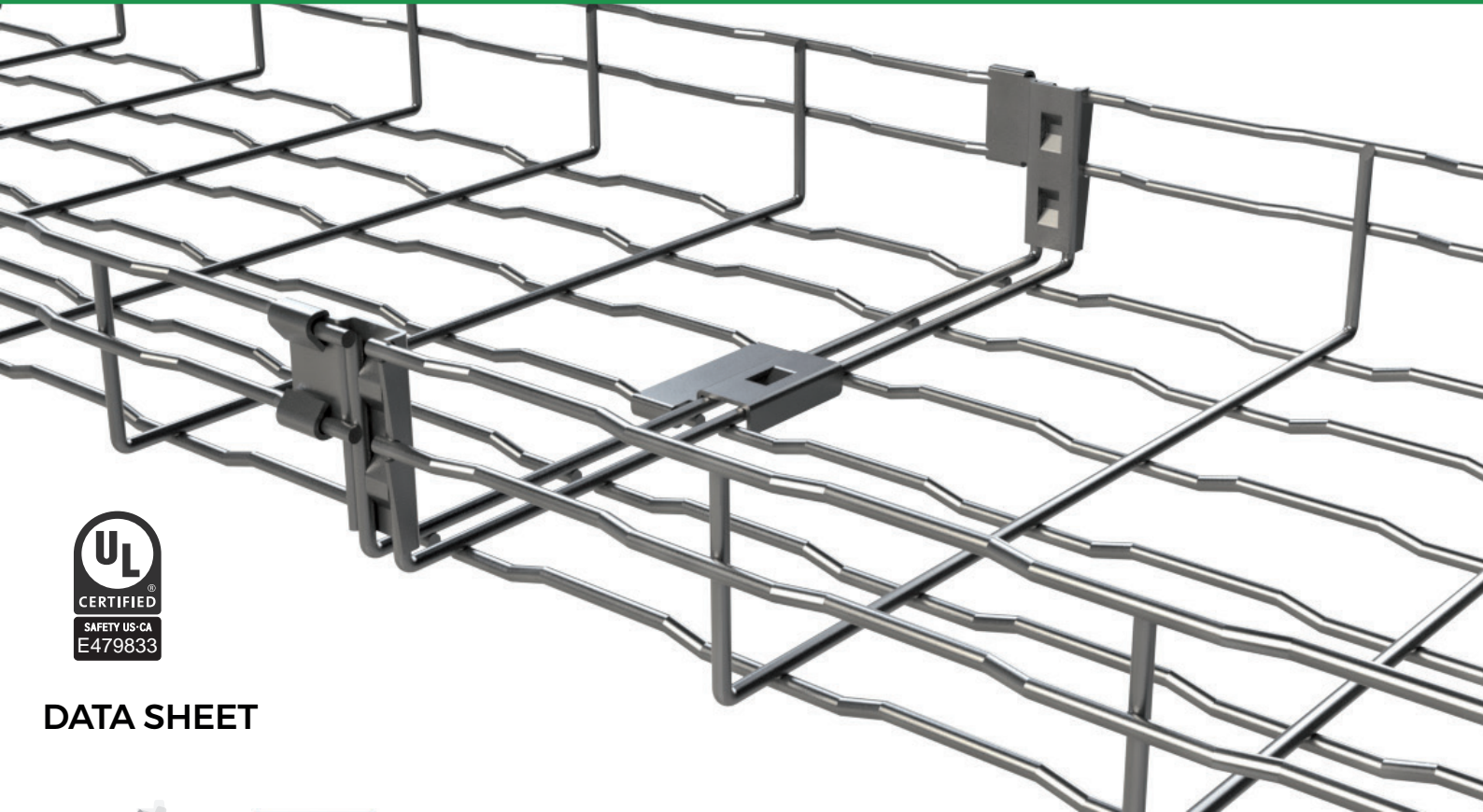

DATA SHEET

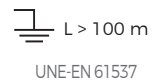
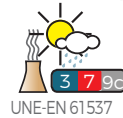
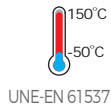

Models BFR:

60x35; 100x35; 150x35; 200x35; 300x35; 60x65;
100x65; 150x65; 200x65; 300x65; 400x65; 450x65;
500x65; 600x65.
200x105; 300x105; 400x105; 450x105; 500x105;
600x105.

Coatings: EZ, HDG

Models BF2R:

60x65; 100x65; 150x65; 200x65; 300x65; 400x65;
450x65; 500x65; 600x65.
100x105; 150x105; 200x105; 300x105; 400x105;
450x105; 500x105; 600x105.

Coatings: EZ, EZ1000

Wire basket characteristics:

Metallic system
Non flame propagating
System with electrical continuity
Maximum temperatura 150°C
Minimum temperatura -50°C
Comply with RoHS, 2011/65/UE
Large range of accessories
Impact resistance: 20J
Metallic coating resistance against the corrosion:



* DIN 4102-12
* CSN 73 0895
* STN 92 0205

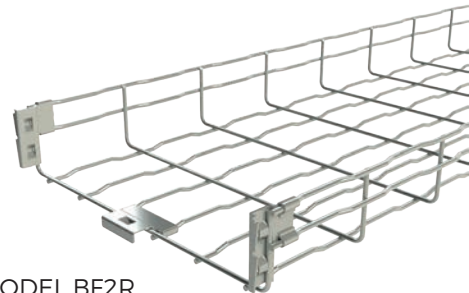

MODEL BF2R

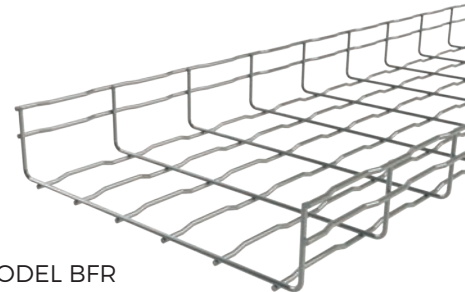

MODEL BFR



ELECTROZINC (EZ)
UNE EN ISO 2081
Recommended for use in interior applications.
Resistance: Class 3



STAINLESS STEEL 304
ASTM A380 ASTM A967 AISI 304
Suitable for food hygiene environments.
Resistance: Class C9C



ELECTROZINC 1000 (EZ1000)
UNE EN ISO 2081
Suitable for humid environments.
1300 hours salt spray resistance.
Resistance: Class 9+





STAINLESS STEEL 316
ASTM A380 ASTM A967 AISI 316
Recommended for marine and extreme environments.
Resistance: Class C9D

HOT DIP GALVANIZED (HDG)
UNE EN ISO 1461
Recommended for exterior applications/harsh environments.
Resistance: Class 5

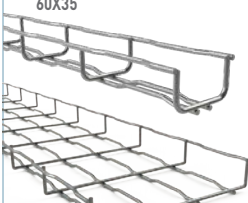
BASORFIL STANDARD BFR H35

60X35 	UNIVOLT PART CODE	B mm	H mm	EZ
				REF.
	BFR60X35EZ	60	35	2/6407
	BFR100X35EZ	100	35	2/3616
	BFR150X35EZ	150	35	2/3617
	BFR200X35EZ	200	35	2/3618
	BFR300X35EZ	300	35	2/3619



L = 3 m

 100, 150, 200  2x URBF35 (2/7271-EZ).
300  2x URBF35 (2/7271-EZ) + 1x CGBF (2/4364-EZ).

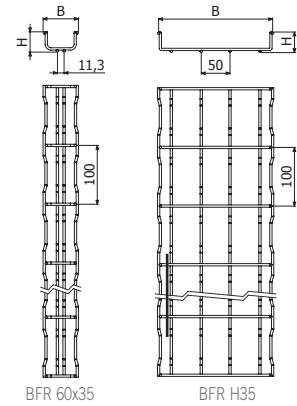
*Stainless Steel 304 & 316 available upon request



BASORFIL SELF-COUPLING BF2R H65

	UNIVOLT PART CODE	B mm	H mm	EZ
				REF.
	BF2R60X65EZ	60	65	2/7389
	BF2R100X65EZ	100	65	2/7248
	BF2R150X65EZ	150	65	2/7249
	BF2R200X65EZ	200	65	2/7250
	BF2R300X65EZ	300	65	2/7251
	BF2R400X65EZ	400	65	2/7394
	BF2R450X65EZ	450	65	2/9989
	BF2R500X65EZ	500	65	2/7395
	BF2R600X65EZ	600	65	2/7396

L = 3 m

*Stainless Steel 304 & 316 available upon request

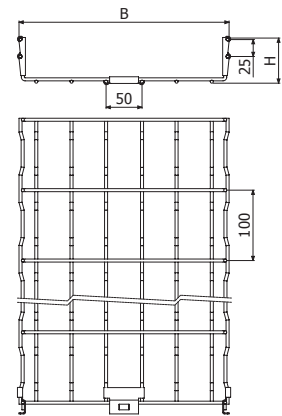

BASORFIL SELF-COUPLING BF2R H65

	UNIVOLT PART CODE	B mm	H mm	EZ1000
				REF.
	BF2R60X65EZ1000	60	65	2/17354
	BF2R100X65EZ 1000	100	65	2/17355
	BF2R150X65EZ 1000	150	65	2/17356
	BF2R200X65EZ1000	200	65	2/17357
	BF2R300X65EZ1000	300	65	2/17358
	BF2R400X65EZ1000	400	65	2/17359
	BF2R450X65EZ1000	450	65	2/17368
	BF2R500X65EZ1000	500	65	2/17361
	BF2R600X65EZ1000	600	65	2/17362

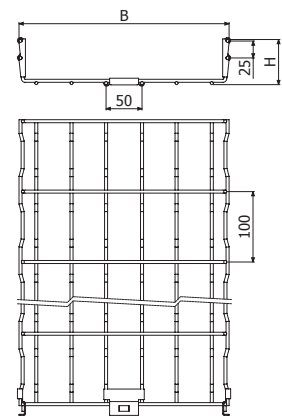

L = 3 m

*Stainless Steel 304 & 316 available upon request



BASORFIL SELF-COUPLING BF2R H105

	UNIVOLT PART CODE	B mm	H mm	EZ
				REF.
	BF2R100X105EZ	100	105	2/7914
	BF2R150X105EZ	150	105	2/7915
	BF2R200X105EZ	200	105	2/7397
	BF2R300X105EZ	300	105	2/7398
	BF2R400X105EZ	400	105	2/7399
	BF2R450X105EZ	450	105	2/9990
	BF2R500X105EZ	500	105	2/7400
	BF2R600X105EZ	600	105	2/7401

L = 3 m (10 ft)

*Stainless Steel 304 & 316 available upon request

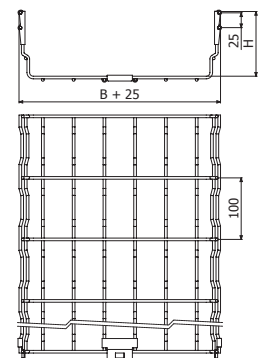

Basorfil BFR/BF2R

ELECTROZINC (EZ) FINISH

BASORFIL SELF-COUPLING BF2R H105



L = 3 m (10 ft)

UNIVOLT PART CODE	B mm	H mm	EZ1000
			REF.
BF2R100X105EZ1000	100	105	2/17363
BF2R150X105EZ1000	150	105	2/17364
BF2R200X105EZ1000	200	105	2/17365
BF2R300X105EZ1000	300	105	2/17366
BF2R400X105EZ1000	400	105	2/17367
BF2R450X105EZ1000	450	105	2/17368
BF2R500X105EZ1000	500	105	2/17369
BF2R600X105EZ1000	600	105	2/17370

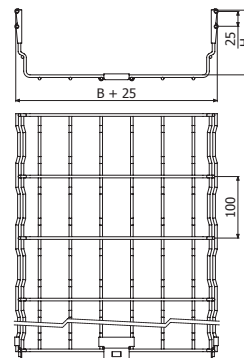

*Stainless Steel 304 & 316 available upon request

COVER LID FOR BASORFIL BFR H35 & BF2R H65



L = 3 m
(400/500/600 - L = 2 m)

UNIVOLT PART CODE	B mm	PG
		REF.
TERE100PG	100	2/1312
TERE150PG	150	2/1313
TERE200PG	200	2/1314
TERE300PG	300	2/1316
TERE400PG	400	2/1317
TERE500PG	500	2/1318
TERE600PG	600	2/1319

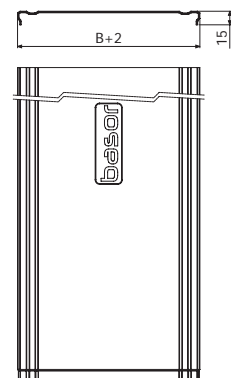

*Stainless Steel 304 & 316 available upon request

COVER LID FOR BASORFIL BF2R H105



L = 3 m
(400/500/600 - L = 2 m)

UNIVOLT PART CODE	B mm	PG
		REF.
TEBFR100X105PG	100	2/1312
TEBFR150X105PG	150	2/1313
TEBFR200X105PG	200	2/1314
TEBFR300X105PG	300	2/1316
TEBFR400X105PG	400	2/1317
TEBFR500X105PG	500	2/1318
TEBFR600X105PG	600	2/1319

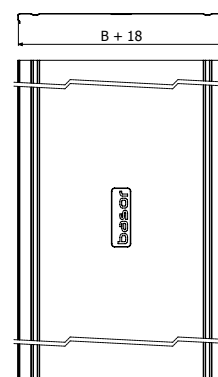

*Stainless Steel 304 & 316 available upon request

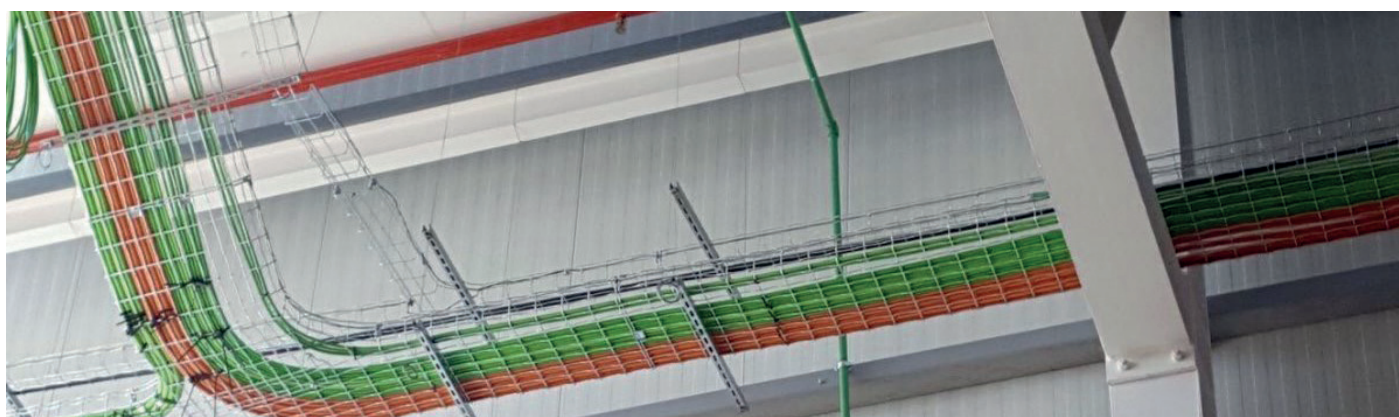

BASORFIL STANDARD BFR H35

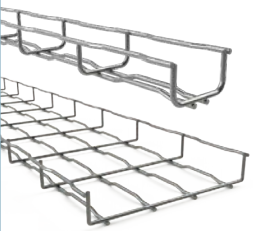

UNIVOLT PART CODE	B mm	H mm	HDG
			REF.
BFR60X35HDG	60	35	2/8230
BFR100X35HDG	100	35	2/0286
BFR150X35HDG	150	35	2/0287
BFR200X35HDG	200	35	2/0288
BFR300X35HDG	300	35	2/0289

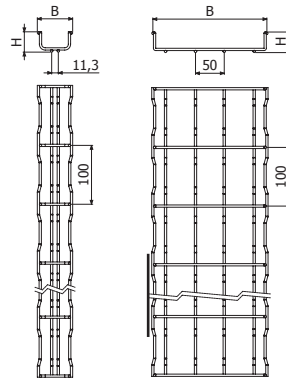
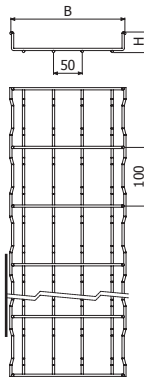



L = 3 m

100, 150, 200 2x URFB35 (2/7772-HDG).
300 2x URFB35 (2/7772-HDG) + 1x CGBF (2/4360-HDG).

*Stainless Steel 304 & 316 available upon request

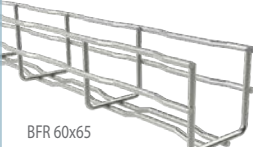
BASORFIL STANDARD BFR H65



UNIVOLT PART CODE	B mm	H mm	HDG
			REF.
BFR-2F60X65HDG	60	55	2/15576
BFR100X65HDG	100	65	2/0291
BFR150X65HDG	150	65	2/0292
BFR200X65HDG	200	65	2/0293
BFR300X65HDG	300	65	2/0294
BFR400X65HDG	400	65	2/0295
BFR450X65HDG	450	65	2/4957
BFR500X65HDG	500	65	2/0296
BFR600X65HDG	600	65	2/0297

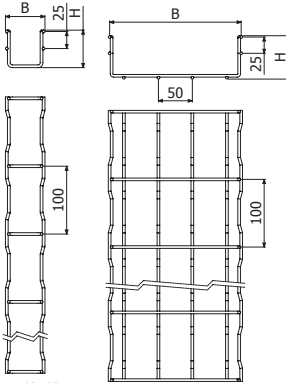
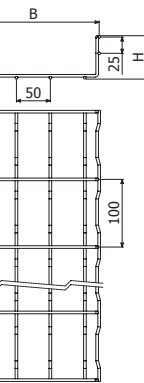



L = 3 m

60, 100, 150, 200 2x URFB65/105 (2/6219-HDG).
300 2x URFB65/105 (2/6219-HDG) + 1x CGBF (2/4360-HDG).

*Stainless Steel 304 & 316 available upon request

BASORFIL STANDARD BFR H105



UNIVOLT PART CODE	B mm	H mm	HDG
			REF.
BFR100X105HDG	100	105	2/7918
BFR150X105HDG	150	105	2/7919
BFR200X105HDG	200	105	2/0298
BFR300X105HDG	300	105	2/0299
BFR400X105HDG	400	105	2/0300
BFR450X105HDG	450	105	2/9548
BFR500X105HDG	500	105	2/0301
BFR600X105HDG	600	105	2/0302

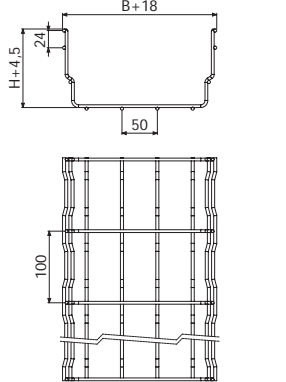
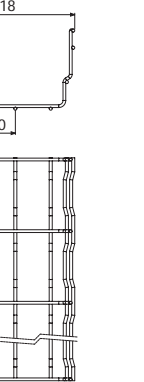



L = 3 m (10 ft)

60, 100, 150, 200 2x URFB65/105 (2/6219-HDG).
300 2x URFB65/105 (2/6219-HDG) + 1x CGBF (2/4360-HDG).

*Stainless Steel 304 & 316 upon request

COVER LID FOR BASORFIL BFR H35 & H65



UNIVOLT PART CODE	B mm	HDG
		REF.
TERE100HDG	100	2/1321
TERE150HDG	150	2/1322
TERE200HDG	200	2/1323
TERE300HDG	300	2/1325
TERE400HDG	400	2/1326
TERE500HDG	500	2/1327
TERE600HDG	600	2/1328

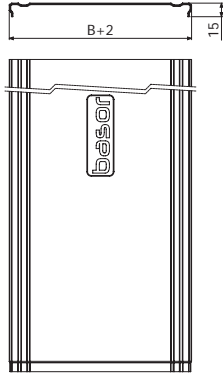

L = 3 m
(400/500/600 - L = 2 m)

*Stainless Steel 304 & 316 under requirement

Basorfil BFR/BF2R

HOT DIP GALVANIZED (HDG) FINISH

COVER LID FOR BASORFIL BFR H105

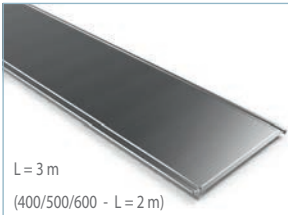

UNIVOLT PART CODE	B mm	HDG
		REF.
TEBFR100HDG	100	2/1321
TEBFR150HDG	150	2/1322
TEBFR200HDG	200	2/1323
TEBFR300HDG	300	2/1325
TEBFR400HDG	400	2/1326
TEBFR500HDG	500	2/1327
TEBFR600HDG	600	2/1328

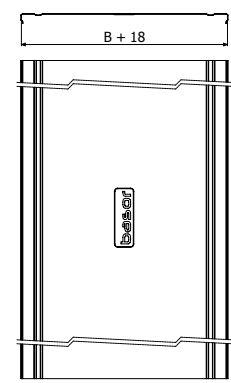

*Stainless Steel 304 & 316 upon request





URBF



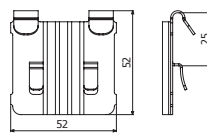

URBF35 URBF65

UNIVOLT PART CODE	Pack	EZ
URBF65/105EZ	Qty.	REF.
URBF35	50	2/6217
	50	2/7271

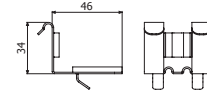
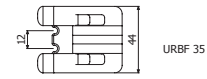
UNIVOLT PART CODE	Pack	HDG
URBF65/105EZ	Qty.	REF.
URBF35	50	2/6219
	50	2/7272







CGBF

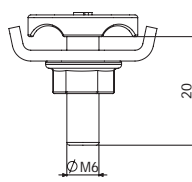
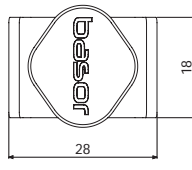

UNIVOLT PART CODE	Pack	EZ
CGBFEZ	Qty.	REF.
	100	2/4364

UNIVOLT PART CODE	Pack	HDG
CGBFHDG	Qty.	REF.
	100	2/4360

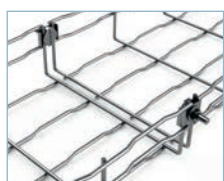

*Stainless Steel 304 & 316 upon request



CTBF

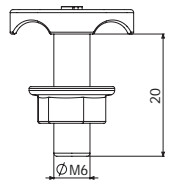
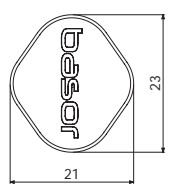

UNIVOLT PART CODE	Pack	EZ
CTBFEZ	Qty.	REF.
	100	2/4362

UNIVOLT PART CODE	Pack	HDG
CTBFHDG	Qty.	REF.
	100	2/7132

*Stainless Steel 304 & 316 upon request

SSC



UNIVOLT PART CODE	Pack	EZ
SSCEZ	Qty.	REF.
	50	2/2064

UNIVOLT PART CODE	Pack	HDG
SSCHDG	Qty.	REF.
	50	2/0363

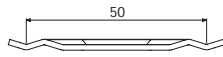
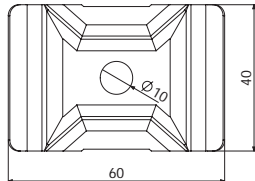







Basorfil BFR/BF2R



ACCESSORIES

SLS

	UNIVOLT PART CODE	Pack	PG
	SLSPG	Qty.	REF.
		36	2/0360

	UNIVOLT PART CODE	Pack	HDG
	SLSHDG	Qty.	REF.
		36	2/0370

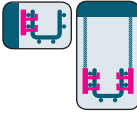
BFR/BF2R 60x65 - 100x65
BFR/BF2R 60x65..200x65



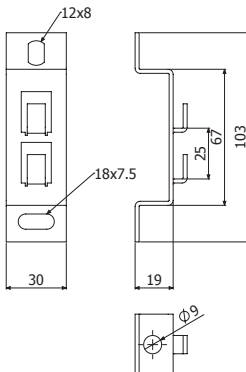

*Stainless Steel 304 & 316 upon request

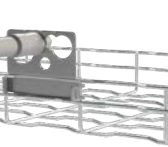

STB2

	UNIVOLT PART CODE	Pack	PG
	STB216-32PG	Qty.	REF.
		12	2/18798

	UNIVOLT PART CODE	Pack	HDG
	STB216-32HDG	Qty.	REF.
		12	2/18799

 *Stainless Steel 304 & 316 upon request

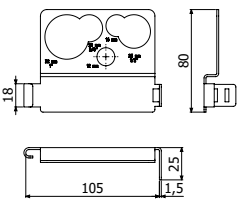

SUC

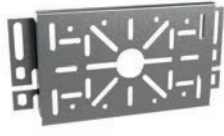
	UNIVOLT PART CODE	Pack	PG
	SUCPG	Qty.	REF.
		4	2/0358

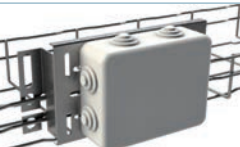
	UNIVOLT PART CODE	Pack	HDG
	SUCHDG	Qty.	REF.
		4	2/0368

 *Stainless Steel 304 & 316 upon request

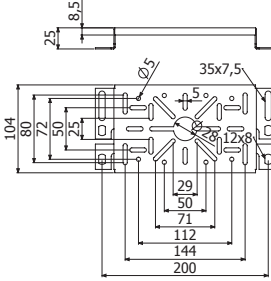
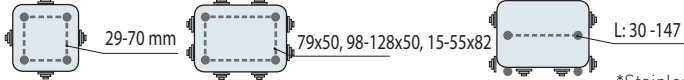



SUCM

	UNIVOLT PART CODE	Pack	PG
	SUCMPG	Qty.	REF.
		20	2/0359

	UNIVOLT PART CODE	Pack	HDG
	SUCMHDG	Qty.	REF.
		20	2/0369

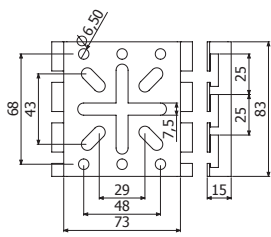
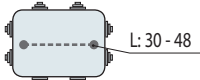
 *Stainless Steel 304 & 316 upon request

MU



UNIVOLT PART CODE
MU500PG

2 x CTBF

Pack	PG
Qty.	REF.
10	2/0357

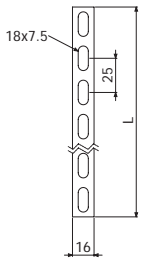
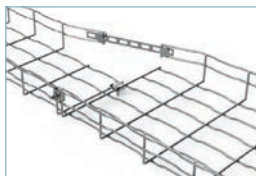
*Stainless Steel 304 & 316 upon request



FSBFR



UNIVOLT PART CODE

Pack	PG
Qty.	REF.
3m	2/9658
3m	2/9659
3m	2/9660
3m	2/9661
3m	2/9662
3m	2/9663
3m	2/9664

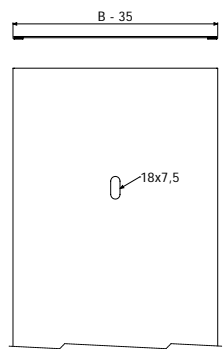
1/100 x B1 (2/4356-EZ) (1000 <-> 1000 mm)

BJC





UNIVOLT PART CODE

Pack	PG
Qty.	REF.
1	2/6451

UNIVOLT PART CODE

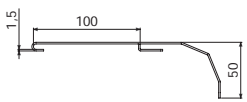
Pack	HDG
Qty.	REF.
1	2/6452

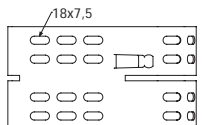

SST



UNIVOLT PART CODE

Pack	PG
Qty.	REF.
25	2/5724

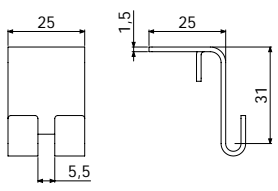
H35 + VR8/VR10

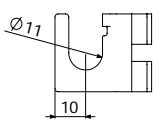

Basorfil BFR/BF2R

ACCESSORIES

PS DIVIDER



L = 3 m (10 ft)



UNIVOLT PART CODE	Pack Qty.	PG REF.
PS35PG	30	2/3476
PS60PG	30	2/2066
PS100PG	30	2/3478

UNIVOLT PART CODE	Pack Qty.	HDG REF.
PS35HDG	30	2/3479
PS60HDG	30	2/3480
PS100HDG	30	2/3482

*Stainless Steel 304 upon request

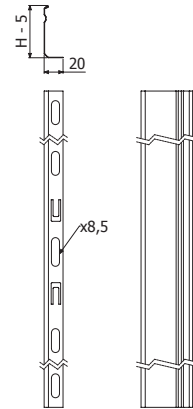

STBF



UNIVOLT PART CODE	Pack Qty.	PG REF.
STBF100X35PG	25	2/9675
STBF60X65PG	25	2/17314
STBF100X65PG	25	2/0886

UNIVOLT PART CODE	Pack Qty.	HDG REF.
STBF100X35HDG	25	2/9857
STBF60X65HDG	25	
STBF100X65HDG	25	

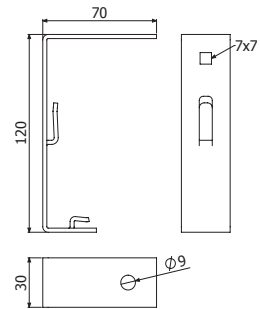

SFL WIFI-LIGHTING

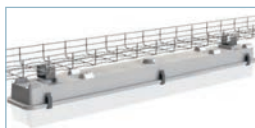

UNIVOLT PART CODE	Pack Qty.	PG REF.
SFLPG	1	2/5906

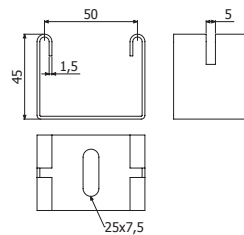

SPBF



UNIVOLT PART CODE	Pack Qty.	PG REF.
SPBF60X35PG	1	2/17591

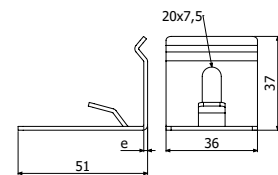

CFBFR

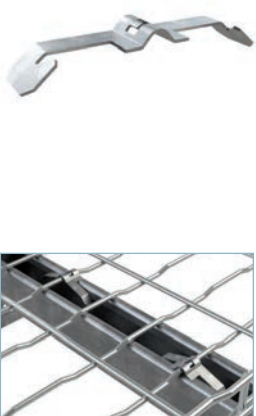

UNIVOLT PART CODE	Pack	i301
CFBFR41301	Qty.	REF.
	100	2/10284

 SP, SP3S, 41/82

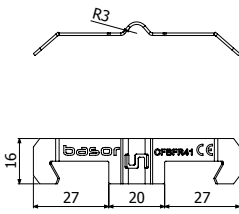



KFS

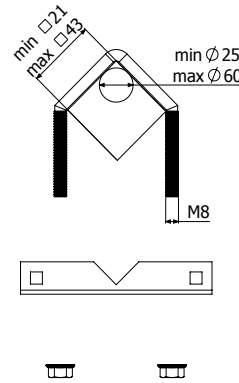

UNIVOLT PART CODE	Pack	PG
KFS	Qty.	REF.
C-SVO 500 FS	20	2/8231
	6	2/1077

 13 C-SVO





UNIVOLT PART CODE	P. Qty.	REF.
UVCROP	1	2/5066
BPZ 400 ml.	1	2/7224



TDC

BPZ

PTBFR



UNIVOLT PART CODE	Pack	PG
PTBFRPG	Qty.	REF.
	20	2/10253

  4 x PTBFR => 1 x TERE (BFR)

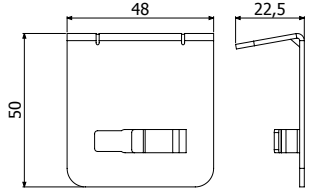

Basorfil BFR/BF2R

SUPPORTS

C-SHO



C-SHO



PSHO

UNIVOLT PART CODE	Pack Qty.	PG	
		REF.	
C-SHO100PG	10	2/7230	
C-SHO150PG	10	2/7231	
C-SHO200PG	10	2/7232	
C-SHO300PG	10	2/7233	
PSHO	12	2/6240	
TFSO (2/0894)			

UNIVOLT PART CODE	Pack Qty.	HDG	
		REF.	
C-SHO100HDG	10	2/7239	
C-SHO150HDG	10	2/7240	
C-SHO200HDG	10	2/7241	
C-SHO300HDG	10	2/7242	
PSHO	12	2/6318	
TFSO (2/0894)			

*Stainless Steel 304 & 316 upon request
 B1 (2/4356-EZ / 2/6826-HDG)

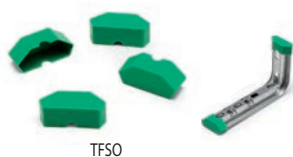

TFSO

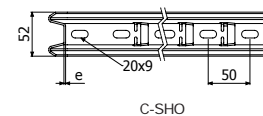
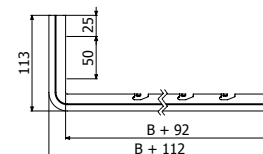

C-SHO

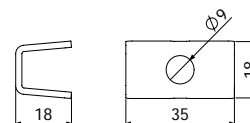

PSHO



SRB



UNIVOLT PART CODE	Pack Qty.	PG REF.	Icon
SRB100PG	2	5	2/6372
SRB150PG	2	5	2/6373
SRB200PG	3	5	2/6374
SRB300PG	4	5	2/6375
SRB400PG	4	5	2/6376
SRB500PG	4	5	2/6377
SRB600PG	4	5	2/6378

UNIVOLT PART CODE	Pack Qty.	HDG	
		REF.	
SRB100HDG	2	1	2/6379
SRB150HDG	2	1	2/6380
SRB200HDG	3	1	2/6381
SRB300HDG	4	1	2/6382
SRB400HDG	4	1	2/6383
SRB500HDG	4	1	2/6384
SRB600HDG	4	1	2/6385

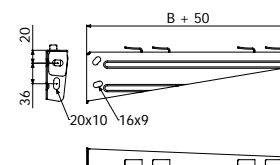
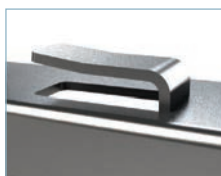

SRB 100/150/200/300/400

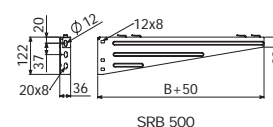

SRB 500

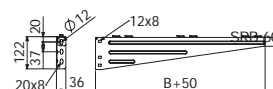

C-SHOT



C-SHOT

UNIVOLT PART CODE	Pack Qty.	PG REF.
C-SHOT100PG	4	2/7235
C-SHOT150PG	4	2/7236
C-SHOT200PG	4	2/7237
C-SHOT300PG	4	2/7238
PSHO	40	2/6240
TFSO (2/0894)		

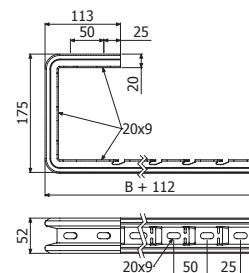

C-SHOT



PSHO

UNIVOLT PART CODE	Pack Qty.	HDG REF.
C-SHOT100HDG	6	2/7244
C-SHOT150HDG	6	2/7245
C-SHOT200HDG	4	2/7246
C-SHOT300HDG	4	2/7247
PSHO	40	2/6318
TFSO (2/0894)		

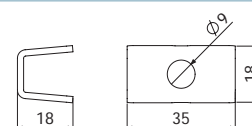

PSHO

- 1 PSHO (2/6240-GS / 2/6318-GC)
- B1 (2/4356-EZ / 2/6826-HDG)

*Stainless Steel 304 & 316 upon request



TFSO

C-SVO



C-SVO 3000

UNIVOLT PART CODE	Pack Qty.	PG REF.
C-SVO100PG	16	2/3630
C-SVO150PG	16	2/1073
C-SVO200PG	12	2/1074
C-SVO300PG	12	2/1076
C-SVO400PG	6	2/3629
C-SVO500PG	6	2/1077
C-SVO600PG	6	2/5941
C-SVO3000PG	3m	2/1101
TFSO (2/0894)		

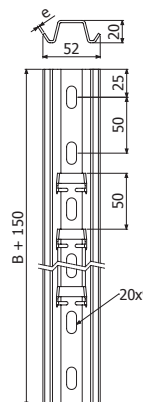

UNIVOLT PART CODE	Pack Qty.	HDG REF.
C-SVO100HDG	16	2/6280
C-SVO150HDG	16	2/1078
C-SVO200HDG	12	2/1079
C-SVO300HDG	12	2/1081
C-SVO400HDG	6	2/5719
C-SVO500HDG	6	2/1082
C-SVO600HDG	6	2/5720
C-SVO3000HDG	3m	-
TFSO (2/0894)		



TFSO

- 2 x DIN976 M8x1000 (2/3397-EZ) + 4/100 x DIN6923 M8 (2/17553-EZ)
- B1 (2/4356-EZ)

*Stainless Steel 304 & 316 upon request

Basorfil BFR/BF2R

SUPPORTS

SP3S



UNIVOLT PART CODE	Pack	EZ
	Qty.	REF.
SP3S400EZ	1	2/18658
SP3S500EZ	1	2/18659
SP3S600EZ	1	2/18660
SP3S800EZ	1	2/18661
SP3S1000EZ	1	2/18662
SP3S1200EZ	1	2/18663

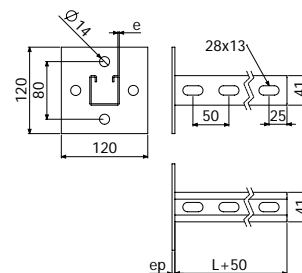

SHST



UNIVOLT PART CODE	Pack	PG
	Qty.	REF.
SHST100PG	4	2/14489
SHST150PG	4	2/14490
SHST200PG	4	2/14491
SHST300PG	4	2/14492
SHST400PG	4	2/14493
SHST500PG	4	2/14494
SHST600PG	4	2/14495

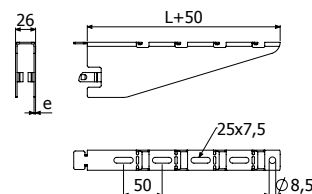

SP3S

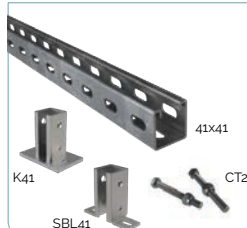

UNIVOLT PART CODE	Pack	PG
	Qty.	REF.
41X41X2-3SPG	3m	2/17313
SBL41-3SPG	1	2/18568
K41-3SEZ	1	2/18567
CT2M8X75EZ	100	2/14492

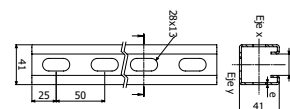

SV



SV 100/150/200/300

UNIVOLT PART CODE	Pack	PG
	Qty.	REF.
SV100PG	10	2/1046
SV150PG	6	2/1047
SV200PG	6	2/1048
SV300PG	6	2/1049

UNIVOLT PART CODE	Pack	HDG
	Qty.	REF.
SV100HDG	10	2/1050
SV150HDG	6	2/1051
SV200HDG	6	2/1052
SV300HDG	6	2/1053

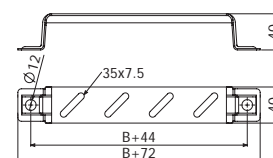

SV 100/150/200/300

B1 (2/4356-EZ / 2/6826-HDG)



CTBF (2/4362-EZ / 2/7132-HDG)

*Stainless Steel 304 & 316 under requirement

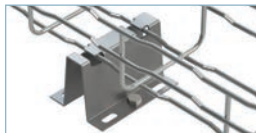

PBF

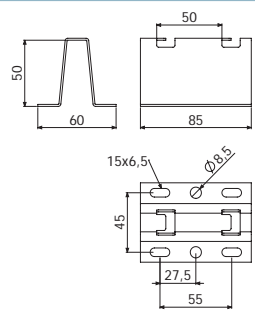

	UNIVOLT PART CODE	Pack	PG
	PBFPG	Qty. 27	REF. 2/5590
	UNIVOLT PART CODE	Pack	HDG
	PBFHDG	Qty. 27	REF. 2/4397



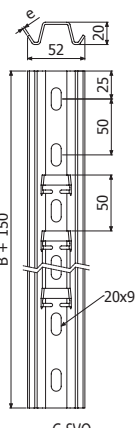

SFS + C-SVO

 C-SVO	UNIVOLT PART CODE	Pack	GS
	C-SVO100	Qty. 16	REF. 2/3630
	C-SVO150	Qty. 16	REF. 2/1073
	C-SVO200	Qty. 12	REF. 2/1074
	C-SVO300	Qty. 12	REF. 2/1076
	C-SVO400	Qty. 6	REF. 2/3629
	C-SVO500	Qty. 6	REF. 2/1077
	C-SVO600	Qty. 6	REF. 2/5941
SFS	Qty. 24	REF. 2/5602	

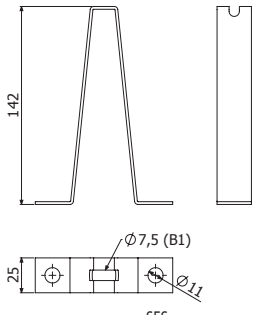
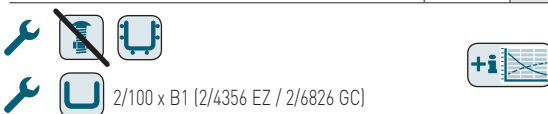

 2 SFS+C-SVO	UNIVOLT PART CODE	Pack	GC
	C-SVO100	Qty. 16	REF. 2/6280
	C-SVO150	Qty. 16	REF. 2/1078
	C-SVO200	Qty. 12	REF. 2/1079
	C-SVO300	Qty. 12	REF. 2/1081
	C-SVO400	Qty. 6	REF. 2/5719
	C-SVO500	Qty. 6	REF. 2/1082
	C-SVO600	Qty. 6	REF. 2/5720
SFS	Qty. 24		

2/100 x B1 (2/4356 EZ / 2/6826 GC)

EARTH TAG TERMINAL

	UNIVOLT PART CODE	Pack	LTN
	BTTL10-35LTN	Qty. 10	REF. 2/8189



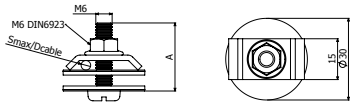

**OTHER
PRODUCTS**

Fast-coupling
**PERFORATED
TRAYS**

Insulating
**PVCM1 UV
TRAYS**

BS LIGHT DUTY

	DESCRIPTION	PG	HDG
	LIGHT	REF.	REF.
	B/P BS 50X12	2/3658	2/3847
	B/P BS 75X12	2/3659	2/3848
	B/P BS 100X12	2/3660	2/3849
	B/P BS 150X12	2/3661	2/3850
	B/P BS 225X12	2/3662	2/3851
	B/P BS 300X18	2/3663	2/3852

BS FLAT BEND

	DESCRIPTION	PG	HDG
	CPBS	REF.	REF.
	CPBS 50X12	2/4321	2/3863
	CPBS 75X12	2/3669	2/3864
	CPBS 100X12	2/3570	2/3865
	CPBS 150X12	2/3671	2/3866
	CPBS 225X12	2/3672	2/3867
	CPBS 300X18	2/3673	2/3868
	CPBS 50X25	2/3745	2/3940
	CPBS 75X25	2/3746	2/3941
	CPBS 100X25	2/3747	2/3942
	CPBS 150X25	2/3748	2/3943
	CPBS 225X25	2/3749	2/3944
	CPBS 300X25	2/3750	2/3945
	CPBS 450X25	2/3751	2/3946
	CPBS 600X25	2/3752	2/3947
	CPBS 750X25	2/3753	2/3948
	CPBS 900X25	2/3754	2/3949
	CPBS 75X50	2/3811	2/4006
	CPBS 100X50	2/3812	2/4007
	CPBS 150X50	2/3813	2/4008
	CPBS 225X50	2/3814	2/4009
	CPBS 300X50	2/3815	2/4010
	CPBS 450X50	2/3816	2/4011
	CPBS 600X50	2/3817	2/4012
	CPBS 750X50	2/3818	2/4013
	CPBS 900X50	2/3819	2/4014

BS INT/EXT BEND

	DESCRIPTION	PG	HDG
	CCCXBS	REF.	REF.
	CCCXBS 50X12	2/4229	2/4258
	CCCXBS 75X12	2/4230	2/4259
	CCCXBS 100X12	2/4231	2/4260
	CCCXBS 150X12	2/4232	2/4261
	CCCXBS 225X12	2/4233	2/4262
	CCCXBS 300X18	2/4234	2/4263
	CCCXBS 50X25	2/4239	2/4268
	CCCXBS 75X25	2/4240	2/4269
	CCCXBS 100X25	2/4241	2/4270
	CCCXBS 150X25	2/4242	2/4271
	CCCXBS 225X25	2/4243	2/4272
	CCCXBS 300X25	2/4244	2/4273
	CCCXBS 450X25	2/4245	2/4274
	CCCXBS 600X25	2/4246	2/4275
	CCCXBS 750X25	2/4247	2/4276
	CCCXBS 900X25	2/4248	2/4277
	CCCXBS 75X50	2/4249	2/4278
	CCCXBS 100X50	2/4250	2/4279
	CCCXBS 150X50	2/4251	2/4280
	CCCXBS 225X50	2/4252	2/4281
	CCCXBS 300X50	2/4253	2/4282
	CCCXBS 450X50	2/4254	2/4283
	CCCXBS 600X50	2/4255	2/4284
	CCCXBS 750X50	2/4256	2/4285
	CCCXBS 900X50	2/4257	2/4286

BS MEDIUM DUTY

	DESCRIPTION	PG	HDG
	MEDIUM	REF.	REF.
	B/P BS 50X25	2/3708	2/3903
	B/P BS 75X25	2/3709	2/3904
	B/P BS 100X25	2/3710	2/3905
	B/P BS 150X25	2/3711	2/3906
	B/P BS 225X25	2/3712	2/3907
	B/P BS 300X25	2/3713	2/3908
	B/P BS 450X25	2/3714	2/3909
	B/P BS 600X25	2/3715	2/3910
	B/P BS 750X25	2/3716	2/3911
	B/P BS 900X25	2/3717	2/3912

BS HEAVY DUTY

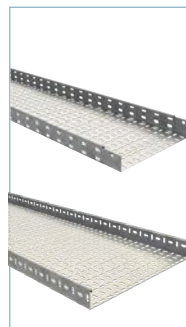
	DESCRIPTION	PG	HDG
	HEAVY	REF.	REF.
	B/P BS 75X50	2/3785	2/3980
	B/P BS 100X50	2/3786	2/3981
	B/P BS 150X50	2/3787	2/3982
	B/P BS 225X50	2/3788	2/3983
	B/P BS 300X50	2/3789	2/3984
	B/P BS 450X50	2/3790	2/3985
	B/P BS 600X50	2/3791	2/3986
	B/P BS 750X50	2/3792	2/3987
	B/P BS 900X50	2/3793	2/3988

BS TEE BEND

	DESCRIPTION	PG	HDG
	TEBS	REF.	REF.
	TEBS 50X12	2/3688	2/3883
	TEBS 75X12	2/3689	2/3884
	TEBS 100X12	2/3690	2/3885
	TEBS 150X12	2/3691	2/3886
	TEBS 225X12	2/3692	2/3887
	TEBS 300X18	2/3693	2/3838
	TEBS 50X25	2/3745	2/3960
	TEBS 75X25	2/3746	2/3961
	TEBS 100X25	2/3747	2/3962
	TEBS 150X25	2/3748	2/3963
	TEBS 225X25	2/3749	2/3964
	TEBS 300X25	2/3770	2/3965
	TEBS 450X25	2/3771	2/3966
	TEBS 600X25	2/3772	2/3967
	TEBS 750X25	2/3773	2/3968
	TEBS 900X25	2/3774	2/3969
	TEBS 75X50	2/3829	2/4024
	TEBS 100X50	2/3830	2/4025
	TEBS 150X50	2/3831	2/4026
	TEBS 225X50	2/3832	2/4027
	TEBS 300X50	2/3833	2/4028
	TEBS 450X50	2/3834	2/4029
	TEBS 600X50	2/3835	2/4030
	TEBS 750X50	2/3836	2/4031
	TEBS 900X50	2/3837	2/4032

BS CROSS BEND

	DESCRIPTION	PG	HDG
	CRBS	REF.	REF.
	CRBS 50X12	2/3698	2/3893
	CRBS 75X12	2/3699	2/3894
	CRBS 100X12	2/3700	2/3895
	CRBS 150X12	2/3701	2/3896
	CRBS 225X12	2/3702	2/3897
	CRBS 300X18	2/3703	2/3898
	CRBS 50X25	2/3775	2/3970
	CRBS 75X25	2/3776	2/3971
	CRBS 100X25	2/3777	2/3972
	CRBS 150X25	2/3778	2/3973
	CRBS 225X25	2/3779	2/3974
	CRBS 300X25	2/3780	2/3975
	CRBS 450X25	2/3781	2/3976
	CRBS 600X25	2/3782	2/3977
	CRBS 750X25	2/3783	2/3978
	CRBS 900X25	2/3784	2/3979
	CRBS 75X50	2/3838	2/4033
	CRBS 100X50	2/3839	2/4034
	CRBS 150X50	2/3840	2/4035
	CRBS 225X50	2/3841	2/4036
	CRBS 300X50	2/3842	2/4037
	CRBS 450X50	2/3843	2/4038
	CRBS 600X50	2/3844	2/4039
	CRBS 750X50	2/3845	2/4040
	CRBS 900X50	2/3846	2/4041

UNION JOINTS

	DESCRIPTION	PG	HDG
	-	REF.	REF.
	JUBS H25	2/3724	2/3919
	JUBS H50	2/3801	2/3996
	JUBS-I H12	2/3668	2/3862
	JUBS-I H25	2/3723	2/3918
	JUBS-I H50	2/3800	2/3995

SCREWS

	DESCRIPTION	PG	HDG
	-	REF.	REF.
	B1 M8X14	2/4356	2/6826



Basorplast BPE

PVC CABLE TRAYS

BPE H60

	DESCRIPTION	PVC
	PVC M1 UV	REF.
	BPE 60X100	2/10070
	BPE 60X150	2/10071
	BPE 60X200	2/10072
	BPE 60X300	2/10073

BPE H100

	DESCRIPTION	PVC
	PVC M1 UV	REF.
	BPE 100X200	2/10074
	BPE 100X300	2/10075
	BPE 100X400	2/10076
	BPE 100X600	2/10077

TBPE

	DESCRIPTION	PVC
	PVC M1 UV	REF.
	TBPE 100	2/10078
	TBPE 150	2/10079
	TBPE 200	2/10080
	TBPE 300	2/10080
	TBPE 400	2/10082
	TBPE 600	2/10083

UNION JOINTS

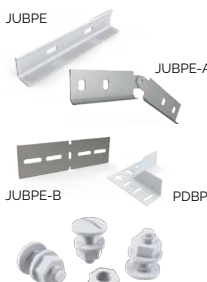
	DESCRIPTION	PVC
	PVC M1 UV	REF.
	JUBPE H60	2/10084
	JUBPE H100	2/10085
	JUBPE-A 60	2/5036
	JUBPE-A 100	2/5037
	JUBPE-B 60	2/3520
	JUBPE-B 100	2/5038
	PDBPE 60/100	2/10135
	CTBP-100	2/10017

OTHER ITEMS

	DESCRIPTION	PVC
	PVC M1 UV	REF.
	KSHGR	2/17282
	CT2 M10X100	2/7228
	PSHG 2M	2/17281
	PSHGR 600	2/17283
	TFPSHGR PVC	2/12112

END COVER

	DESCRIPTION	PVC
	PVC M1 UV	REF.
	TFBPE 60X100	2/10136
	TFBPE 60X150	2/10137
	TFBPE 60X200	2/10138
	TFBPE 60X300	2/10139
	TFBPE 100X200	2/10140
	TFBPE 100X300	2/10141
	TFBPE 100X400	2/10142
	TFBPE 100X600	2/10143

FLAT BEND

	DESCRIPTION	BEND	COVER
	PVC M1 UV	REF.	REF.
	CBPE 60X100	2/10089	2/10097
	CBPE 60X150	2/10090	2/10098
	CBPE 60X200	2/10091	2/10099
	CBPE 60X300	2/10092	2/10100
	CBPE 100X200	2/10093	2/10099
	CBPE 100X300	2/10094	2/10100
	CBPE 100X400	2/10095	2/10101
	CBPE 100X600	2/10096	2/10102

INSIDE BEND

	DESCRIPTION	BEND	COVER
	PVC M1 UV	REF.	REF.
	CCBPE 60X100	2/10103	2/10111
	CCBPE 60X150	2/10104	2/10112
	CCBPE 60X200	2/10105	2/10113
	CCBPE 60X300	2/10106	2/10114
	CCBPE 100X200	2/10107	2/10115
	CCBPE 100X300	2/10108	2/10116
	CCBPE 100X400	2/10109	2/10117
	CCBPE 100X600	2/10110	2/10118

OUTSIDE BEND

	DESCRIPTION	BEND	COVER
	PVC M1 UV	REF.	REF.
	CXBPE 60X100	2/10119	2/10127
	CXBPE 60X150	2/10120	2/10128
	CXBPE 60X200	2/10121	2/10129
	CXBPE 60X300	2/10122	2/10130
	CXBPE 100X200	2/10123	2/10131
	CXBPE 100X300	2/10124	2/10132
	CXBPE 100X400	2/10125	2/10133
	CXBPE 100X600	2/10126	2/10134

SUPPORTS

	DESCRIPTION	PVC
	PVC M1 UV	REF.
	SHG 100	2/10011
	SHG 150	2/10012
	SHG 200	2/10013
	SHG 300	2/10014
	SHG 400	2/10015
	SHG 600	2/10016
	SVG 100	2/10050
	SVG 150	2/10051
	SVG 200	2/10052
	SVG 300	2/10053
	SVG 400	2/10054
	SVG 600	2/10055

BIK10-BPE

	DESCRIPTION	SS304	SS316
	Stainless Steel	REF.	REF.
	BIK10-BPE 60X100	2/17340	2/17347
	BIK10-BPE 60X150	2/17341	2/17348
	BIK10-BPE 60/100X200	2/17342	2/17349
	BIK10-BPE 60/100X300	2/17343	2/17350
	BIK10-BPE 100X400	2/17345	2/17352
	BIK10-BPE 100X600	2/17346	2/17353

A large rectangular area filled with a fine grid pattern, intended for handwritten notes.



TECHNICAL DATA SHEETS





BF2R (UNE-EN 61537)

BF2R 60x65

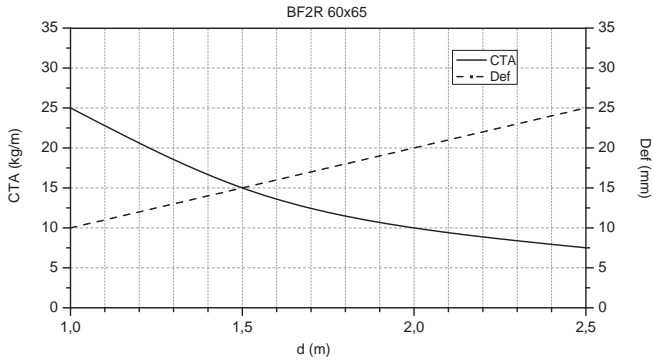

BF2R 100..300 H65

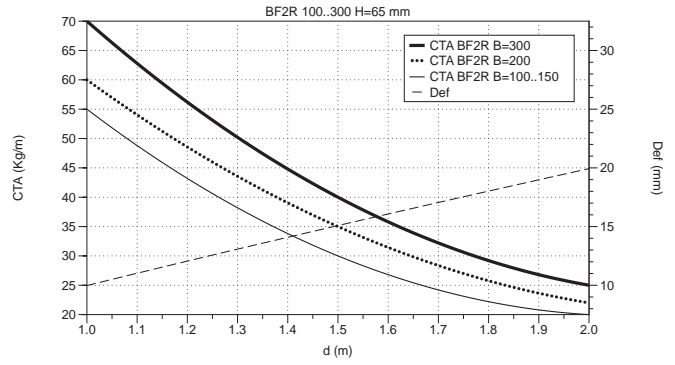

BF2R 400..600 H65

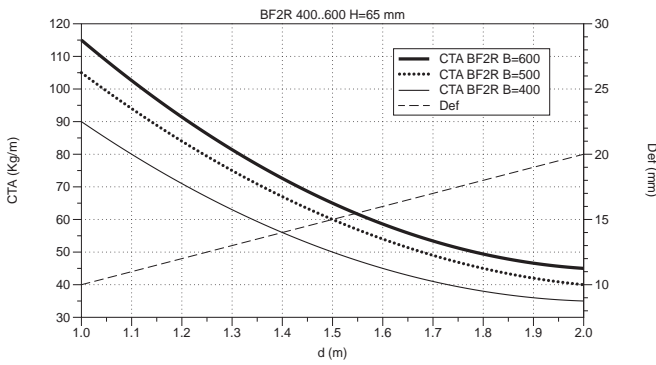

BF2R 100..300 H105

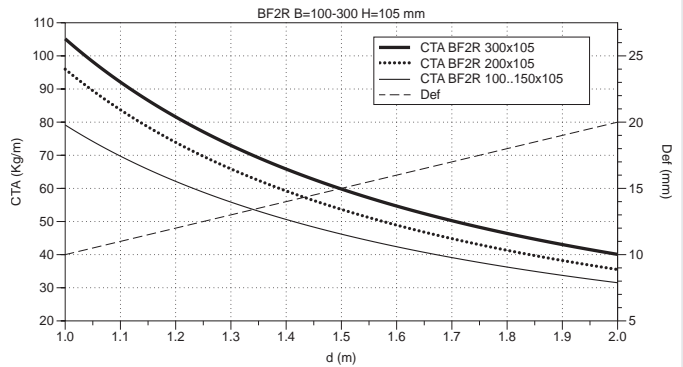

BF2R 400..600 H105

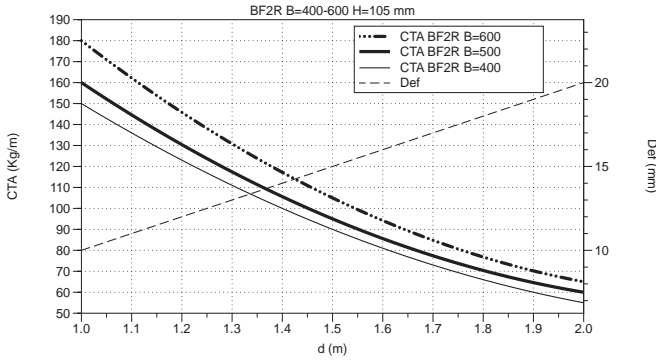

BFR-2F 60x65 (UNE-EN 61537)

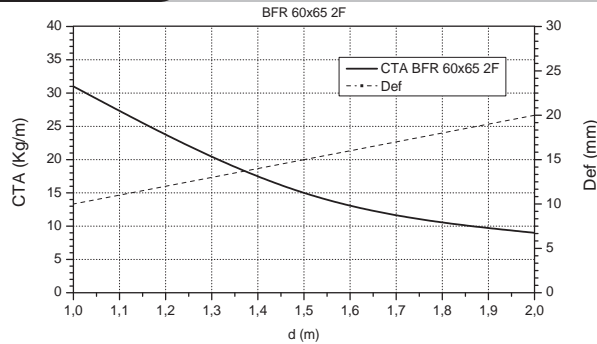



BFR (UNE-EN 61537)

BFR 60x65

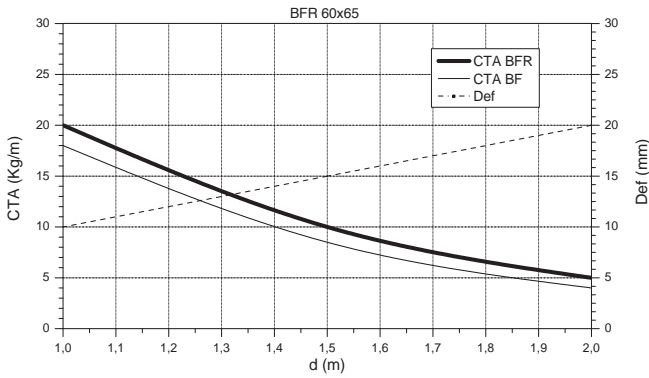

BFR 60x65 i304 / i316

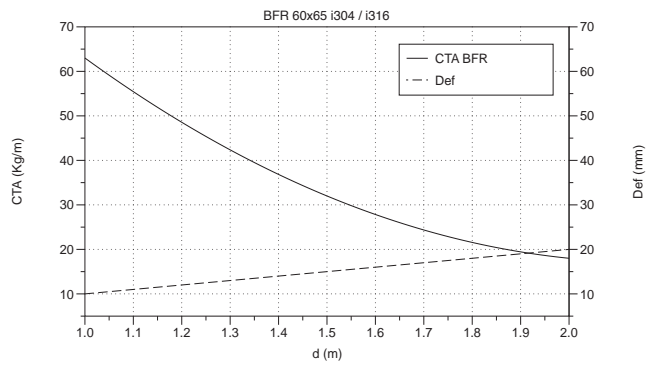

BFR H35

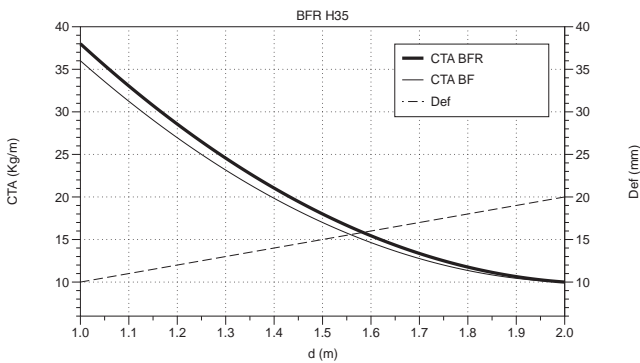

BFR H35 i304 / i316

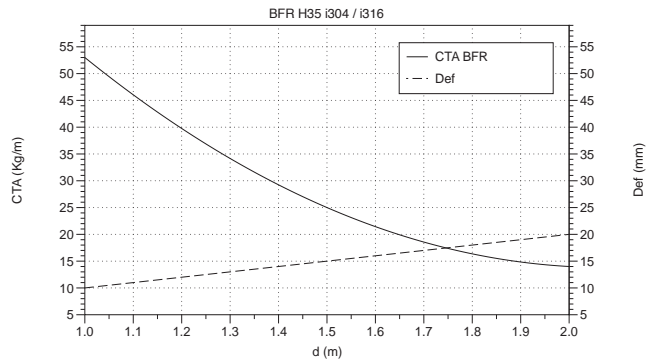

BFR H65

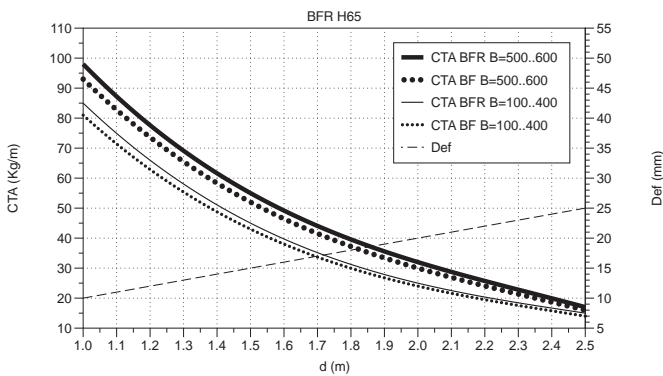

BFR H65 i304 / i316

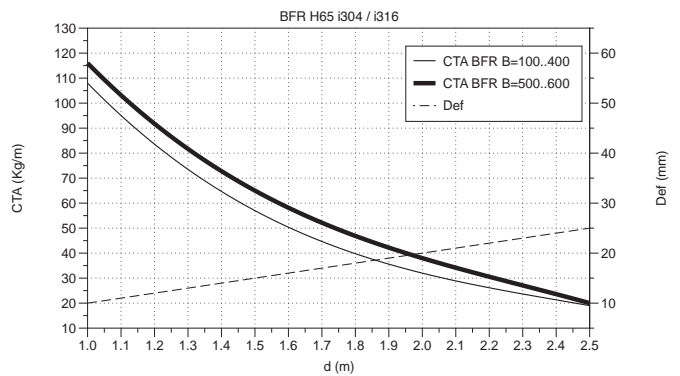

BFR H105

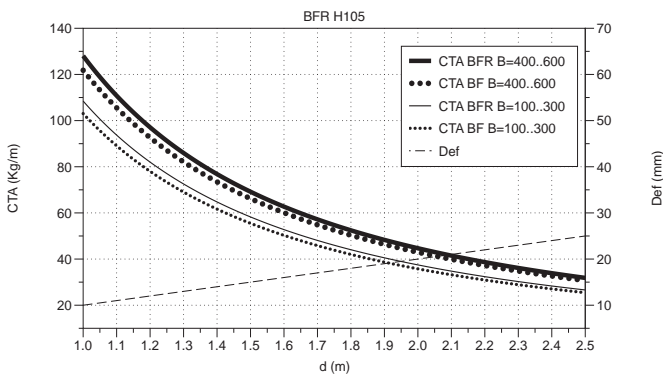

BFR H105 i304 / i316

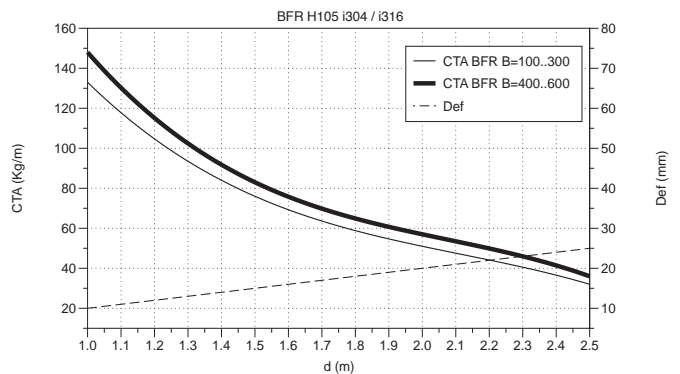



BS (UNE-EN 61537)

BS Light Duty H12 / H18

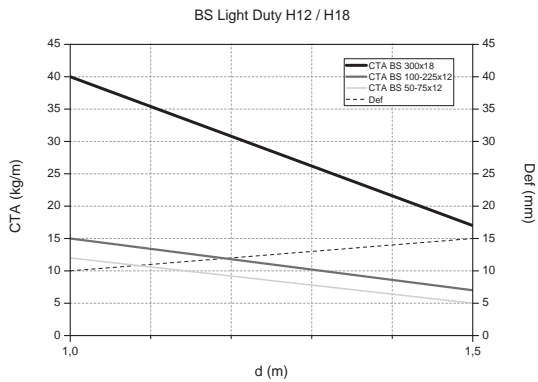

BS Medium Duty H25

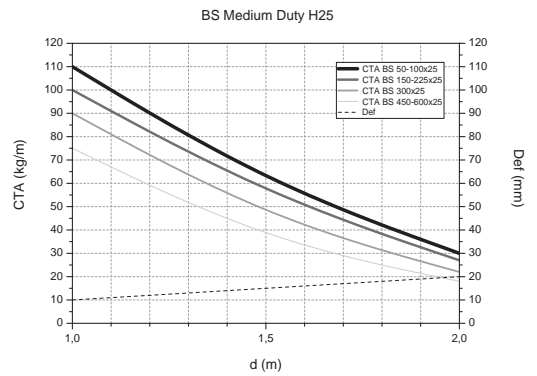

BS Heavy Duty H50

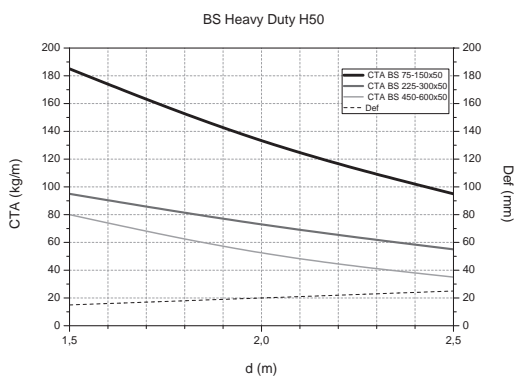

BASORPLAST

BPE (UNE-EN 61537)

MAX. 40°C			MAX. 60°C	
MODEL	SWL (Kg/m)		MODEL	Distance 1 m
	Distance 1 m	Distance 1,5 m		
BPE-60x100	39	20	BPE-60x100	20
BPE-60x150	43	22	BPE-60x150	22
BPE-60x200	64	31	BPE-60x200	31
BPE-60x300	74	38	BPE-60x300	38
BPE-100x200	119	57	BPE-100x200	57
BPE-100x300	125	61	BPE-100x300	61
BPE-100x400	168	81	BPE-100x400	81
BPE-100x600	227	112	BPE-100x600	112

SHG 100..300

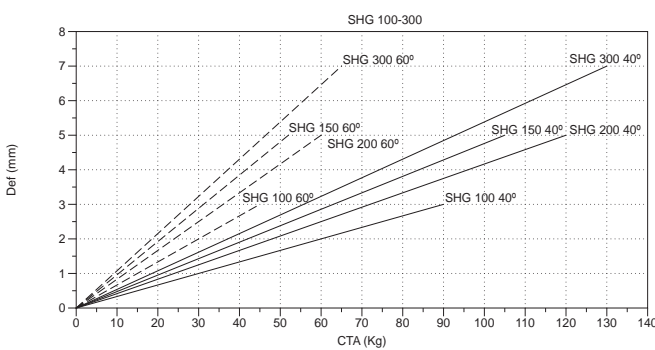

SHG 400..600

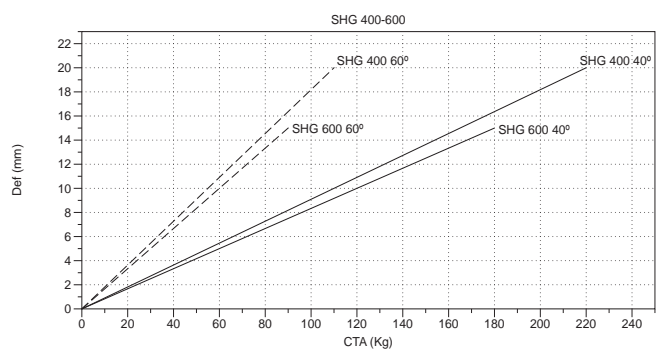

SVG 40°C

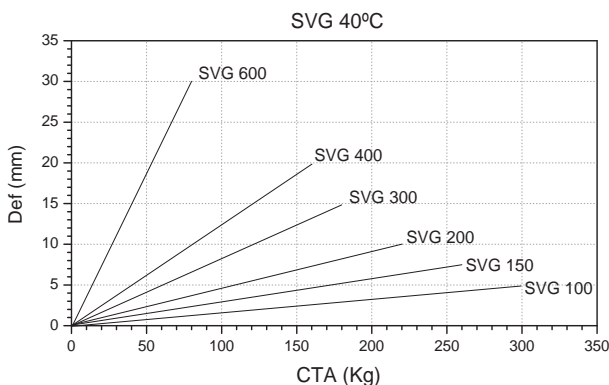

SVG 60°C

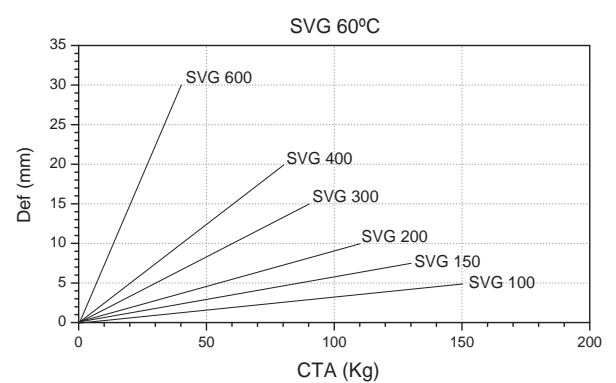



SUPPORTS (UNE-EN 61537)

C-SHO

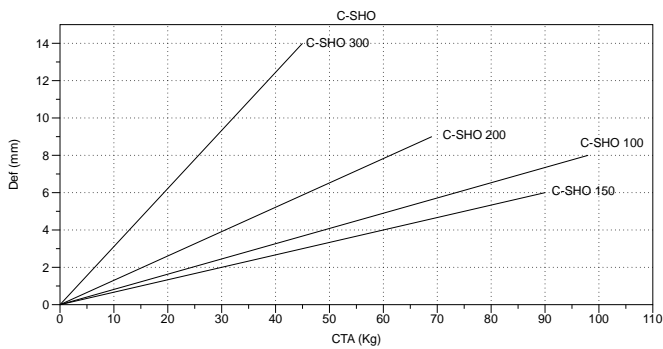

SCR

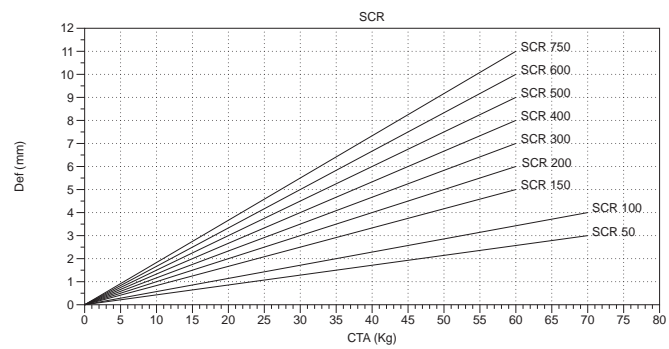

SRB

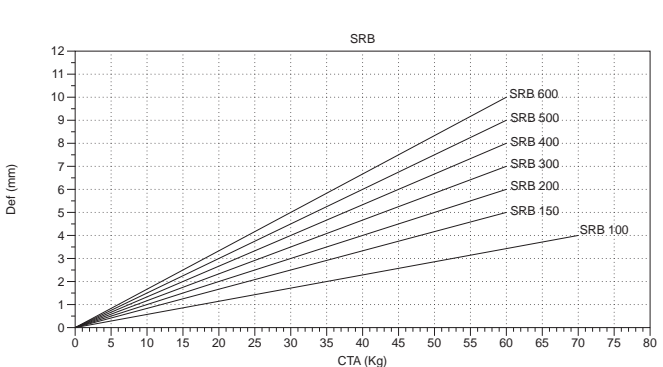

C-SVO+VRO

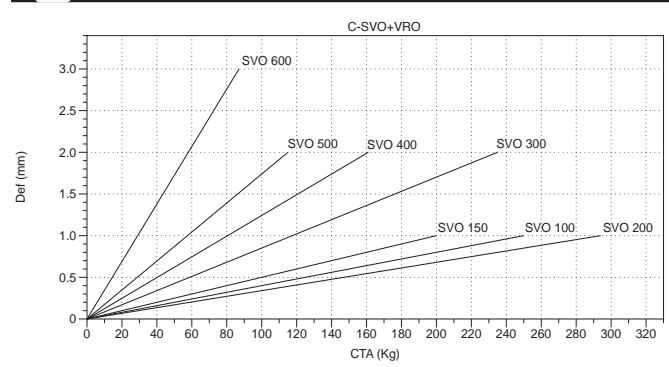

C-SHOT

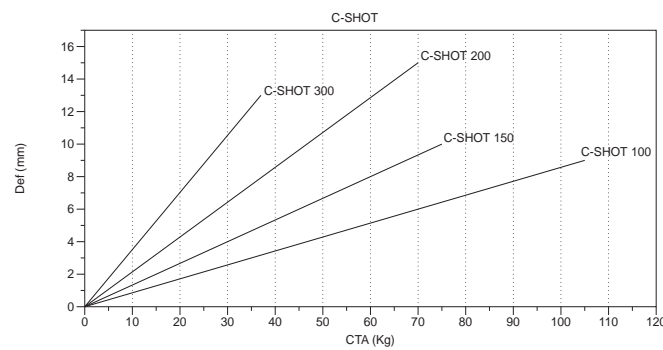

SP3S

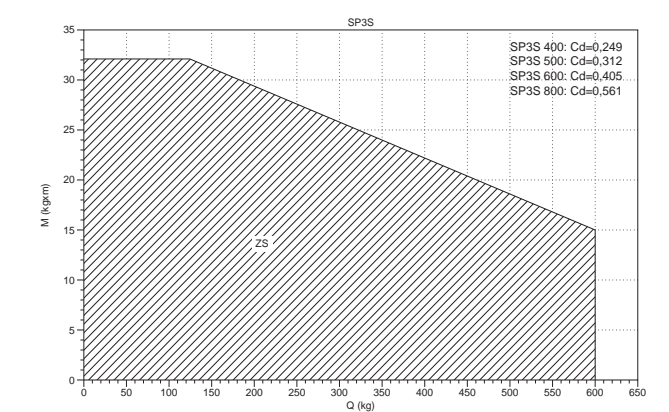

SV

B		CTA	
mm	inch	kg	Lb
100	4"	276	609
150	6"	265	584
200	8"	253	558
300	12"	207	456
400	16"	506	1116
500	20"	460	1014
600	24"	414	912

SFS +C-SVO

B		CTA	
mm	inch	kg	Lb
100	4"	176	388
150	6"	176	388
200	8"	176	388
300	12"	176	388
400	16"	161	354
500	20"	115	253
600	24"	87	191



A large rectangular area filled with a fine grid pattern, intended for handwritten notes or technical drawings.



DIETZEL
UNIVOLT

3E Basor
CABLE TRAY SPECIALIST

CABLE MANAGEMENT ALLIANCE



Univolt UK

Unit 4, Quadrant Park
Mundells
Welwyn Garden City
AL7 1FS

T- 01707 379820
W- www.univolt.co.uk
M- sales@univolt.co.uk