

DRAPER®

INSTRUCTIONS FOR Cordless Drills

Stock Nos.79193, 78944, 78945, 78946, 78947

Part Nos.CHD141V, CHD181V2, CHD141V2, CHD1804VPLUS, CHD1404VPLUS

IMPORTANT: PLEASE READ THESE INSTRUCTIONS CAREFULLY TO ENSURE THE SAFE AND EFFECTIVE USE OF THIS PRODUCT.



CE

CHD1804VPLUS SHOWN

04/2005

DRAPER®

GENERAL INFORMATION

This manual has been compiled by Draper Tools and is an integrated part of the product with which it is enclosed and should be kept with it for future references.

This manual describes the purpose for which the product has been designed and contains all the necessary information to ensure its correct and safe use. We recommend that this manual is read before any operation or, before performing any kind of adjustment to the product and prior to any maintenance tasks. By following all the general safety instructions contained in this manual, it will ensure both product and operator safety, together with longer life of the product itself.

All photographs and drawings in this manual are supplied by Draper Tools to help illustrate the operation of the product.

Whilst every effort has been made to ensure accuracy of information contained in this manual, the Draper Tools policy of continuous improvement determines the right to make modifications without prior warning.



CONTENTS

Contents/Declaration 1

Specification/Guarantee 2

Power Supply 3

General Safety Instructions 4

Added Safety Instructions 5

Getting to Know Your Cordless Hammer Drill 6

Operation and Use 7-9

Optional Accessories 10



DECLARATION OF CONFORMITY

We :
 Draper Tools Ltd.,
 Hursley Road,
 Chandler's Ford,
 Eastleigh, Hampshire.
 SO53 1YF.
 England.

Declare under our sole responsibility that the product:

Stock Nos:- **79193, 78945, 78944, 78946, 78947.**

Part Nos:- **CHD141V, CHD141V2, CHD181V2, CHD1804VPLUS, CHD1404VPLUS.**

Description:- **Cordless Drills.**

To which this declaration relates is in conformity with the following directive(s)
 98/37/EC, 73/23/EEC & 89/336/EEC

With reference to:

EN60335-2-29+A11, EN60335-1+A1+A2+A11+A12+A13+A14+A15+A16, EN55014-1:2000,
 EN61000-3-2:1995+A1:1998+A2:1998+A14:2000, EN61000-3-3:1995, EN55014-21:1997,
 EN61000-4-2:1995+A1:1998, EN61000-4-4:1995, EN61000-4-5:1995, EN61000-4-6:1996,
 EN61000-4-11:1994, EN50081-1:1992 & EN50082-2-1:1997.

J.N. Draper
 Managing Director

15/04/2005

SPECIFICATION

The Draper Tools policy of continuous improvement determines the right to change specification without notice.

Stock No.	79193	78945	78947	78944	78946
Part No.	CHD141V	CHD141V2	CHD1404VPLUS	CHD181V2	CHD1804VPLUS
Battery pack	1 x 14.4V DC	2 x 14.4V DC	2 x 14.4V DC	2 x 18V DC	2 x 18V DC
Cells	1.7Ah	1.7Ah	2.4Ah	1.7Ah	2.4Ah
Drilling capacity					
Wood	22mm	22mm	32mm	25mm	38mm
Mild Steel	10mm	10mm	12mm	13mm	13mm
Masonry	12mm	12mm	13mm	12mm	16mm
Max Torque	230kgf-cm/22.5Nm	230kgf-cm/22.5Nm	480kgf-cm/47Nm	290kgf-cm/28Nm	500kgf-cm/49Nm
Speed (no load)	0-330RPM/0-1100RPM	0-330RPM/0-1100RPM	0-360RPM/0-1150RPM	0-400RPM/0-1200RPM	0-400RPM/0-1200RPM
Blows per min.	14300	14300	14950	15600	15600
Chuck capacity	13mm	13mm	13mm	13mm	13mm
Spindle thread	1/2" x 20 TPI	1/2" x 20 TPI	1/2" x 20 TPI	1/2" x 20 TPI	1/2" x 20 TPI
Motor	Johnson 600	Johnson 600	Johnson 700	Mabuchi 700	Johnson 800
Weight (machine and battery only)	2.3kg	2.5kg	3.3kg	3.5kg	3.9kg
Sound pressure level	91.79dB(A)	91.79dB(A)	91.79dB(A)	87.13dB(A)	87.13dB(A)
Sound power level	101.31dB(A)	101.31dB(A)	101.31dB(A)	95.08dB(A)	95.08dB(A)
Vibration level	7.41m/s ²	7.41m/s ²	7.41m/s ²	8.16m/s ²	8.16m/s ²

GUARANTEE (Hand held professional electrical power tools)

Draper hand held professional electric power tools have been carefully tested and inspected before shipment and are guaranteed to be free from defective materials and workmanship for a period of 12 months from the date of purchase except where tools are hired out when the guarantee period is ninety days from the date of purchase.

Should the machine develop any fault where warranty applies, arrangements will be made for the tool to be returned free-of-charge to the Service Centre at Draper Tools Limited.

Please contact: DRAPER HELPLINE – (023) 8049 4344

A proof of purchase must be provided with the tool.

If upon inspection it is found that the fault occurring is due to defective materials or workmanship the product will be repaired and tested as soon as possible free of charge, normally within five working days. This guarantee does not apply to normal wear and tear, nor does it cover any damage caused by misuse, careless or unsafe handling, alterations, accident, or repairs attempted by any personnel other than the Service Centre at Draper Tools Limited or other authorised agent.

Note: If the tool is found not to be within the Terms of Warranty, repair and carriage charges will be quoted and made accordingly.







This guarantee applies in lieu of any other guarantee expressed or implied and variations of its terms are not authorised.

Your Draper guarantee is not effective unless you produce a dated receipt or invoice to verify your proof of purchase within the 12 month period.

Please note that this guarantee is an additional benefit and does not affect your statutory rights.

Draper Tools Limited.

- Connecting to the Power Supply:

To eliminate the possibility of an electric shock your machine has been fitted with a BS approved, non rewirable moulded plug and cable which incorporates a fuse, the value of which is indicated on the pin face of the plug. If the plug is marked with the  symbol and the fuse needs replacing, an  approved BS1362 fuse must be used of the same amp rating. If the plug is not  marked, a fuse with the  symbol,  BS Kitemark, or both  and  BS Kitemark, of the same amp rating should be used.

- The fuse cover is detachable, never use the plug with the cover omitted. If a replacement fuse cover is required, ensure it is the same colour as that visible on the pin face of the plug (i.e. red). Fuse covers are available from your Draper Tools stockist.

If the fitted plug is not suitable, it should be cut off and destroyed. *The end of the cable should now be suitably prepared and the correct type of plug fitted. See below.

- *WARNING:

A plug with bare flexible wires exposed is hazardous if engaged in a live power socket outlet.

- WARNING: THIS APPLIANCE IS DOUBLE INSULATED. □

- The mains lead is coloured Blue – Neutral, Brown – Live.
- As these colours may not correspond with the coloured markings identifying the terminals in your plug, proceed as follows:
- The wire which is coloured blue must be connected to the terminal which is marked with the letter 'N' or coloured black or blue.

The wire which is coloured brown must be connected to the terminal which is marked with the letter 'L' or coloured red or brown.

- EXTENSION LEAD CHART:

Extension lead sizes shown assure a voltage drop of not more than 5% at rated load of tool.

Ampere rating (on Name plate)	3	6	10	13
Extension cable length (Metres)	Wire Size mm ²			
7.5	0.75	0.75	1.0	1.25
15	0.75	0.75	1.0	1.5
22.5	0.75	0.75	1.0	1.5
30	0.75	0.75	1.25	1.5
40	0.75	0.75	1.5	2.5

WARNING:

Please read the following instructions carefully, failure to do so could lead to serious personal injury. When using electric tools, basic safety precautions, including the following, should always be followed to reduce the risk of fire, electric shock and personal injury. Read all these instructions before operating this product and save these instructions.

IMPORTANT:

Draper Tools Limited recommends that this machine should not be modified or used for any application other than that for which it was designed. If you are unsure of its relative applications do not hesitate to contact us in writing and we will advise you.

1. KNOW YOUR POWER TOOL:

Read and understand the owner's manual and labels affixed to the tool. Learn its application and limitations as well as the specific potential hazards peculiar to this tool.

2. KEEP WORK AREA CLEAN:

Cluttered areas and benches invite accidents. Floors must not be slippery due to oil or sawdust.

3. AVOID DANGEROUS ENVIRONMENTS:

Do not use power tools in damp or wet locations, or expose them to rain. Keep work area well lit. Provide adequate space surrounding the work area. Do not use in environments with a potentially explosive atmosphere.

4. KEEP CHILDREN AWAY:

All visitors should be kept a safe distance from work area.

5. STORED TOOLS:

When not being used, all tools should be stored in a dry, locked cupboard and out of the reach of children.

6. WEAR PROPER CLOTHING:

Do not wear loose clothing, neckties or jewellery (rings, wristwatches) to catch in moving parts. NONSLIP footwear is recommended. Wear protective hair covering to contain long hair. Roll long sleeves above the elbow.

7. USE SAFETY GOGGLES (Head Protection):

Wear CE approved safety goggles at all times. Normal spectacles only have impact resistant lenses, they are NOT safety glasses. Also, use face or dust mask if application is dusty and ear protectors (plugs or muffs) during extended periods of operation.

8. NOISE LEVELS:

Some types of machines may have high noise levels when working. In such cases ear protection must be worn.

9. VIBRATION LEVELS:

Hand held power tools produce different vibration levels. You should always refer to the specifications and relevant Health and Safety guide.

10. DUST EXTRACTION:

If your tool is fitted with a dust extraction fitting, always ensure that it is connected and being used with a dust extractor. Vacuum cleaners can be used if suitable for the material being extracted.

11. PROTECT YOURSELF FROM ELECTRIC SHOCK:

When working with power tools, avoid contact with any earthed items (e.g. pipes, radiators, hobs and refrigerators, etc.). If you are using a power tool in extreme conditions (e.g. high humidity or generating metal dust), always use an RCD (residual current device) at the power socket.

12. STAY ALERT:

Always watch what you are doing and use common sense. Do not operate a power tool when you are tired or under the influence of alcohol or drugs.

13. WHEN WORKING OUT OF DOORS:

Only use extension leads designed for that purpose.

14. ACCESS TO MAINS SOCKET:

If a stationary machine is fitted with a moulded plug and cable, the machine should not be positioned so that access to the mains socket is restricted.

15. DISCONNECT POWER TO THE TOOL:

When not in use, before servicing and when changing accessories such as cutters, etc.

16. AVOID ACCIDENTAL STARTING:

Make sure the switch is in the OFF position before plugging the machine into the power supply.

17. NEVER LEAVE MACHINE RUNNING UNATTENDED:

Turn power off. Do not leave machine until it comes to a complete stop.

18. DO NOT ABUSE THE CORD:

Never carry the tool by the power cable or pull it from the socket. Keep the power cable away from heat, oil and sharp edges. If the supply cord is damaged, it must be replaced by the manufacturer or its service agent or a similarly qualified person in order to avoid hazard.

19. NEVER STAND ON TOOL:

Serious injury could occur if the tool is tipped or if the cutting tool is accidentally contacted. Do not store materials above or near the tool, so that it is necessary to stand on the tool to reach them.

20. CHECK DAMAGED PARTS:

Before further use of the tool, a guard or other part that is damaged should be carefully checked to determine that it will operate properly and perform its intended function. Check for alignment of moving parts, free running of moving parts, breakage of parts, mounting and any other conditions that may affect its operation. A guard or other part that is damaged should be repaired properly or replaced by an authorized service centre unless otherwise indicated in this instruction manual. Have defective switches replaced by an authorized service facility. Do not use the tool if the switch does not turn it on and off.

21. KEEP GUARDS IN PLACE:

And in working order.

22. MAINTAIN TOOLS WITH CARE:

Keep tools sharp and clean for the best and safest performance. Follow instructions for lubricating and changing accessories. All extension cables must be checked at regular intervals and replaced if damaged. Always keep the hand grips on the tool clean, dry and free of oil and grease.

23. USE RECOMMENDED ACCESSORIES:

Consult the owners manual for recommended accessories. Follow the instructions that accompany the accessories. The use of improper accessories may cause hazards.

24. REMOVE ADJUSTING KEYS AND WRENCHES:

Form a habit of checking to see that keys and adjusting wrenches are removed from the tool before turning it on.

25. SECURE WORK:

Use clamps or a vice to hold work. This frees both hands to operate the tool.

26. DO NOT OVERREACH:

Keep proper footing and balance at all times.

27. USE RIGHT TOOL:

Do not force the tool or attachment to do a job for which it was not designed.

28. DO NOT FORCE TOOL:

It will do the job better and safer at the rate for which it was designed.

29. DIRECTION OF FEED:

Feed work into a blade or cutter against the direction of rotation of the blade or cutter only.

30. WHEN DRILLING OR SCREWING INTO WALLS:

Always make sure there is no danger of hitting any hidden power cables, water or gas pipes in the wall.

31. HAVE YOUR TOOL REPAIRED BY A QUALIFIED PERSON:

This electric tool is in accordance with the relevant safety requirements. Repairs should only be carried out by qualified persons using original spare parts, otherwise this may result in considerable danger to the user.

IMPORTANT NOTE:

Residual Risk. Although the safety instructions and operating manuals for our tools contain extensive instructions on safe working with power tools, every power tool involves a certain residual risk which can not be completely excluded by safety mechanisms. Power tools must therefore always be operated with caution!

Safety is a combination of operator common sense and alertness at all times when the drill is being used.

- **WARNING:**

For your own safety do not attempt to use your drill until the battery is fully charged. Remember the drill is always in a operating condition as it does not need to be connected to a power supply. When not in use, place the direction of rotation switch in the neutral position. Before drilling check that there are no hidden hazards such as electrical cables, water or gas pipes running below the surface - use as a metal/ voltage detector.
Do not expose either the drill or charger to rain or water.
Do not overcharge the battery (more than six hours) as this could damage the battery cells.

- **HEALTH AND SAFETY FOR BATTERIES:**

General: Do not put in fire or mutilate - cells may burst or release toxic materials. Do not short circuit cells, may cause burns.

- **DISPOSAL:**

Do not mutilate batteries, corrosive electrolyte will be released.
Do not incinerate - danger of explosion and release of toxic fumes.
Do not dispose of batteries or cells in a charged condition.
Expired nickel-cadmium batteries must be recycled/disposed of in accordance with the appropriate regulations or legislation. They should be returned to your local warranty agent/stockist.





CHD1804VPLUS SHOWN

- | | |
|---------------------------|---------------------------|
| ① Variable Speed Trigger. | ⑥ Screwdriver Bit Holder. |
| ② Direction Switch. | ⑦ Soft Grip Handle. |
| ③ Keyless Chuck. | ⑧ Sliding Battery Pack. |
| ④ Torque Control. | ⑨ 1 Hour Fast Charger. |
| ⑤ Speed Select Switch. | |

- **UNPACKING:** After removing the packing material, make sure the product is in perfect condition and that there are no visible damaged parts. If in doubt, do not use the cordless hammer drill and contact the dealer from whom it was purchased.

The packaging materials (plastic bags, polystyrene, etc.), must be disposed of in an appropriate refuse collection container. These materials must not be left within the reach of children as they are potential sources of danger.

- **BATTERY CHARGING (Figs.1 & 2):**

To charge the battery pack, it must first be removed from the drill. To release the battery pack, squeeze the grips located on either side of the battery casing and gently slide the battery pack from the rear of the housing (Fig.1).

Plug the battery charger unit into a 230V/AC 13amp, three pin socket. The amber light (A) will illuminate. Slide the battery on to the charger as shown (Fig.2). Do not force, ensure the battery is inserted correctly. The red light (B) on the charger will now illuminate to show that the battery is fast charging. If the green light illuminates, remove the battery. This indicates the temperature of the battery is too high or low. When the battery is at room temperature, re-try. When the battery is fully charged, the red light will go out and the green light will illuminate to indicate it is now trickle charging (approx. 1 hour). The battery pack can then be removed and used to power the tool. To refit the battery pack to the drill, push firmly until the battery pack locates and snaps into place.

- **NOTE:** The battery was discharged after manufacturing and will therefore require five to ten charges/discharges before it reaches its full capacity.

- **INSTALLING AND REMOVING BITS (Fig.3):**

This drill is fitted with a keyless spindle lock chuck, which will allow single hand tightening of the bit in the chuck. Place the drill bit shoulder into the chuck as far as it will go, then hand tighten.

Short screwdriver bits need only be inserted to the depth of the hexagon shank before tightening chuck by hand.

- **DIRECTION SWITCH (Fig.4):**

The switch determines the direction of rotation of the chuck, i.e. clockwise or anticlockwise.

To alter the direction of rotation, stop the drill and push switch (C) to the left or right. When the direction switch is pushed to the left, the chuck will rotate clockwise. When the switch is pushed to the right, the chuck will rotate anticlockwise. Before operation, check that the switch is set in the required position. Do not change the direction of rotation until the chuck comes to a complete stop. When the drill is not in use move the direction switch to the neutral position (the middle setting) to lock the trigger out.

FIG.1



FIG.2

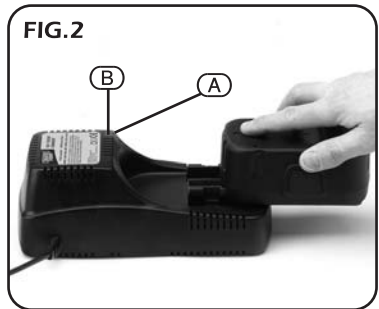
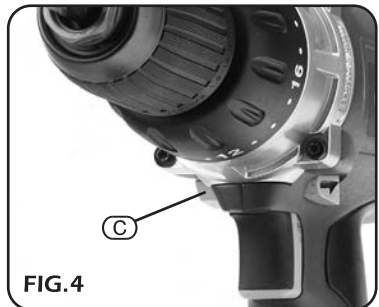

FIG.3



FIG.4



- CHANGING SPEEDS (Fig.5):

To change the speed of the chuck, slide the two-speed gearbox selection switch (D) forwards for low speed, or backwards for high speed.

- IMPORTANT: Only change speed when the machine has stopped.

- TRIGGER:

When the trigger is depressed, the chuck will rotate (provided the direction switch is set in the forward or reverse position). This trigger switch is electronic which enables the user to vary the speed continuously in both gears. The speed varies according to how far the trigger switch is depressed. The further it is depressed, the faster the chuck will rotate. The lighter it is depressed, the slower it will rotate.

- TORQUE CONTROL (Fig.6):

By turning the collar (E) it is possible to adjust the amount of torque. In the "twist drill" setting □□□, the drill/screwdriver has full torque.

In the "hammer drill" setting □□□, the hammer feature will come into action. This is mostly used for drilling into masonry etc.

Settings 1-20 can be used in either gear and provide a facility for setting the torque to the required level. For example, this means that repetitive driving of screws of the same size will be driven into the material to the same torque, thus giving the same fixing strength, or in the case of countersunk screws, these will all be driven to the same depth in the material.

The torque control prevents the heads of small diameter screws being twisted off when correctly set.

- SCREWDRIVER BIT HOLDER (Fig.7):

The drill comes equipped with a bit holder (F) on either side of the housing to hold the two double ended bits supplied.

FIG.5



FIG.6



FIG.7



- **BATTERY INDICATOR (Fig.8):**

CHD1404VPLUS and CHD1804VPLUS only.

Both these models come equipped with a quick and easy indicator to show the battery packs power at a glance. Press button (G) and the LED's (H) will show the remaining power left in the battery.

FIG.8

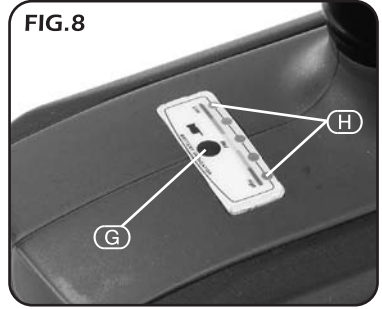

- **HOLDING THE DRILL (Figs.9 & 10):**

The drill casing is designed to be held comfortably in two ways;

1. By the handle.
2. Or by the in-line support grip.

- **DRILLING WOOD AND PLASTIC:**

To prevent splitting around the drill holes on the reverse side, place a piece of scrap timber under the material to be drilled.

- **DRILLING MASONRY:**

Start drilling at a low speed to prevent the drill bit from wandering. Once penetration is achieved, fully depress the trigger to achieve maximum speed and hammer power.

- **DRILLING METAL:**

Metals such as sheet steel, aluminium and brass may be drilled. Mark the point to be drilled with a centre punch to help the drill bit tip to locate.

- **SCREWDRIVING:**

To prevent slip or damage to the screwhead, match the screwdriver bit to the screwhead size. To remove screws, move the direction switch to the reversing position and apply pressure to the screwhead and depress the trigger slowly.

FIG.9



FIG.10



Stock No.	Part No.	Description
69457	CB141	14.4V (1.7Ah)
79411	CB144PLUS	14.4V (2.4Ah)
69458	CB181	18V (1.7Ah)
79412	CB184PLUS	18V (2.4Ah)

- At the end of the machine's working life, or when it can no longer be repaired, ensure that it is disposed of according to UK regulations.
- Contact your local authority for details of collection schemes in you area.
- In all circumstances:
Do not dispose of power tools with domestic waste.
Do not abandon in the environment.



- **DRAPER TOOLS LIMITED,**
Hursley Road,
Chandler's Ford,
Eastleigh,
Hampshire.
SO53 1YF. U.K.
- **Helpline:** (023) 8049 4344.
- **Sales Desk:** (023) 8049 4333.
- **General Enquiries:** (023) 8026 6355.
- **Fax:** (023) 8026 0784
- **Internet:** www.draper.co.uk
- **E-mail:** sales@drapertools.com

YOUR DRAPER STOCKIST