

GENERAL INFORMATION

BATTERY

The timeswitch is fitted with a non-rechargeable, non-serviceable long life battery, which will maintain the clock and programmed time settings with the mains supply disconnected.

THIS RESERVE SHOULD BE SUFFICIENT TO COVER POWER INTERRUPTIONS DURING THE LIFE OF THE UNIT.

During power interruptions the display will be blank.

SERVICE AND REPAIR

This timeswitch is NOT user serviceable. Please do not dismantle the unit. In the unlikely event of a fault developing please refer to the **RESETTING THE TIMESWITCH** section of this user guide located on page 7. If this fails to resolve the problem please contact a local heating engineer or a qualified electrician.

INDEX

INTRODUCTION	PAGE 1
PRODUCT OVERVIEW	PAGE 1
DISPLAY INFORMATION	PAGE 2
DEFAULT SETTINGS	PAGE 2
ADJUSTING TIME AND DATE	PAGE 3
ADJUSTING CLOCK OPTIONS	PAGE 4
ADJUSTING CHANNEL HEADINGS	PAGE 4
SETTING THE PROGRAMME TIMES	PAGE 5
SETTING HOLIDAY MODE	PAGE 6
OVERRIDE FACILITY	PAGE 6
BOOST FUNCTION	PAGE 7
ADVANCE FUNCTION	PAGE 7
RESET PROCEDURE	PAGE 7
GENERAL INFORMATION	PAGE 8

CHANNELPLUS H17XL SERIES 2
USER INSTRUCTIONS



HORSTMANN

ChannelPlus H17XL Series 2 Single Channel Timeswitch

Offers up to three on and off operations per day on a weekly schedule. Series 2 ChannelPlus timeswitches directly replace earlier ChannelPlus models.

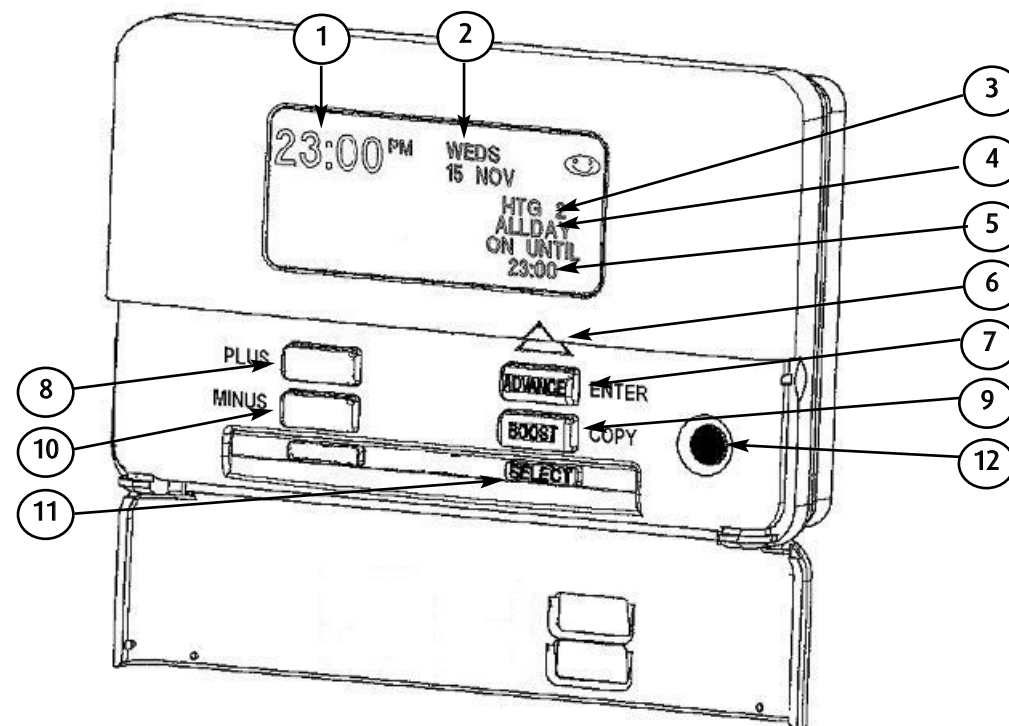

PRODUCT OVERVIEW - DETAIL SHOWN WITH THE FLAP LOWERED

LCD DISPLAY FEATURES - A fully graphical back-lit display which allows the user the best possible interface with the programme times and functions -

- 1 Current TIME OF DAY
- 2 Day of Week
- 3 Heading
- 4 Current programme
- 5 Next switch time

LED INDICATOR - Illuminated buttons give a visual feedback to user operations, as well as indicating the status of the unit.

- 6 ON indicator

EASY TO USE PROGRAMME AND OVERRIDE BUTTONS - A menu driven display and a preset clock / calendar means that programming is made simple. A one touch override facility makes temporary changes simple to use and view.

- 7 ADVANCE and ENTER button
- 8 PLUS button
- 9 BOOST and COPY button
- 10 MINUS button
- 11 Programme Select button (Coloured Blue)
- 12 SET button (Coloured Green)

DISPLAY INFORMATION

Diagram 1

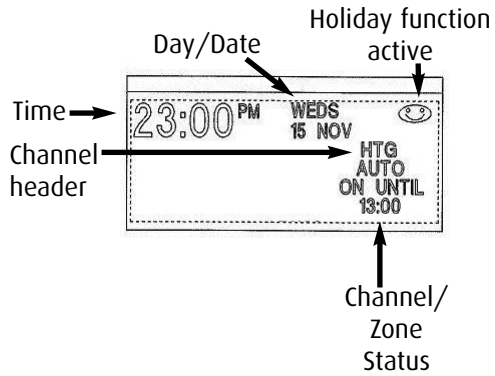

The ChannelPlus H17XL Series 2 timeswitch has a fully graphical, back-lit display. In the normal run mode the display will show current programme information, see diagram 1 opposite. The information displayed will change depending upon the settings made and which mode you are in. During different programming modes and/or setting screens the current time, day/date, holiday indicator will only appear when necessary, this is to reduce confusion during the programming process. This is explained further in later sections of this guide.

FRONT COVER

The simple instructions contained in this user guide are designed to help with the programming and operation of the unit. Most of the following instructions require the front flap to be lowered. Please replace the flap when normal operation is required.

ADJUSTING DEFAULT SETTINGS

The ChannelPlus H17XL Series 2 has a number of default settings which are factory preset. These settings are designed to reduce the need for user intervention upon installation of the timeswitch. However it is possible to customise the user display by following the procedures in the following pages. The factory defaults are illustrated below;

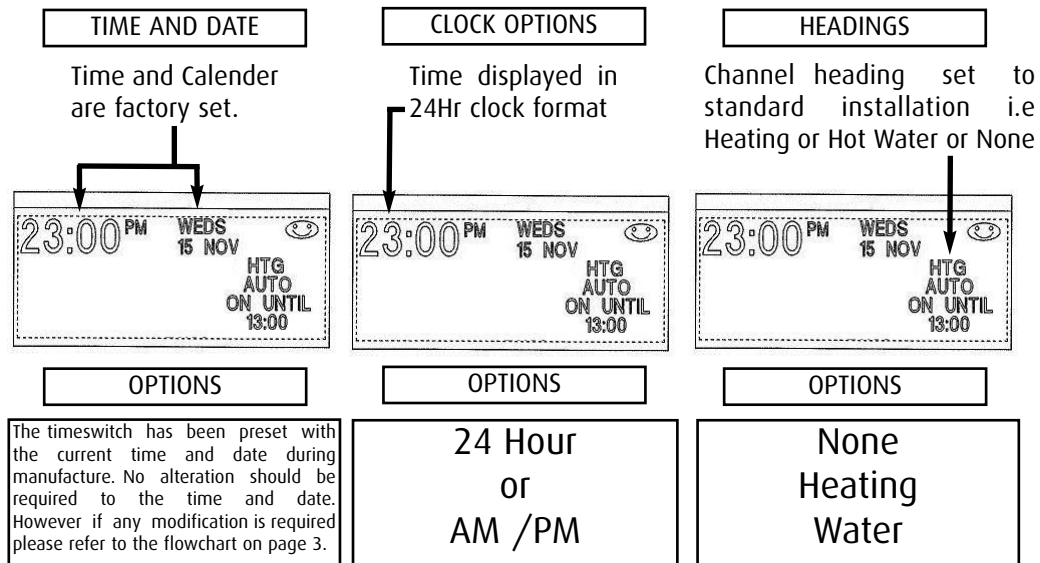

BOOST FUNCTION - 1 OR 2 HOUR TEMPORARY OVERRIDE

The Boost facility will allow the user to either activate the timeswitch which is currently 'OFF' for either 1 or 2 hours, or to extend a current period by 1 or 2 hours. To indicate the boost being activated the 'BOOST' button will stay illuminated for the duration of the boost/extension period. The display will also indicate the extension to the time visually on the display.

The chart below illustrates the different options available.

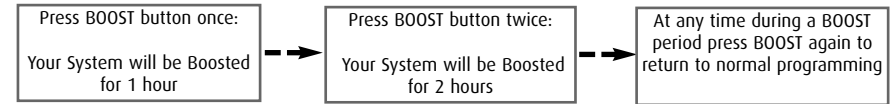

ADVANCE FUNCTION - BRINGS FORWARD THE NEXT ON OR OFF OPERATION

The Advance facility will allow the user to either bring a programme 'ON' which is currently 'OFF' or switch a programme 'OFF' which is currently 'ON'. To indicate the Advance feature being activated the 'ADVANCE' button will stay illuminated until the next programme switching time, the user display will also change to indicate the status of the timeswitch and the next switching time.

The chart below illustrates the different options available.

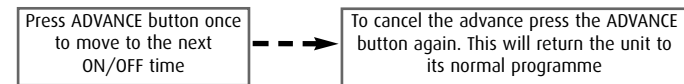

RESETTING THE CHANNELPLUS H17XL SERIES 2

Electronic equipment can in some circumstances be affected by electrical interference. If the display becomes frozen or scrambled; or if you wish to revert back to the default settings please use the following procedure.

RESET PROCEDURE

PLEASE NOTE; Using this procedure will restore the ChannelPlus to the original factory programme settings, the time setting will also default to **1st January 2005** - See Adjusting Time and Date on page 3.

Lower the front flap of the unit. Press the ADVANCE(Enter) and SELECT(Blue) buttons together then release the buttons and the timeswitch will return to the preset factory settings.

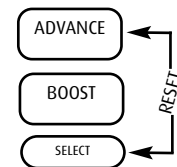

SETTING THE HOLIDAY MODE

The holiday mode can be used to suspend the program function of the ChannelPlus timeswitch, it can be set in advance of your departure date and for as long a period as required. The holiday function operates from mid-day to mid-day, this means it can be easily set to ensure your home is warm for your return. When the holiday mode has been set a smiley face '☺' will appear on the display. When the holiday mode is active **only** the day / date and smiley face will be displayed.

To cancel an active holiday period please press any of the Select buttons under the front flap.

PLEASE NOTE; Any alteration to the current time or date will cancel any Holiday programme set

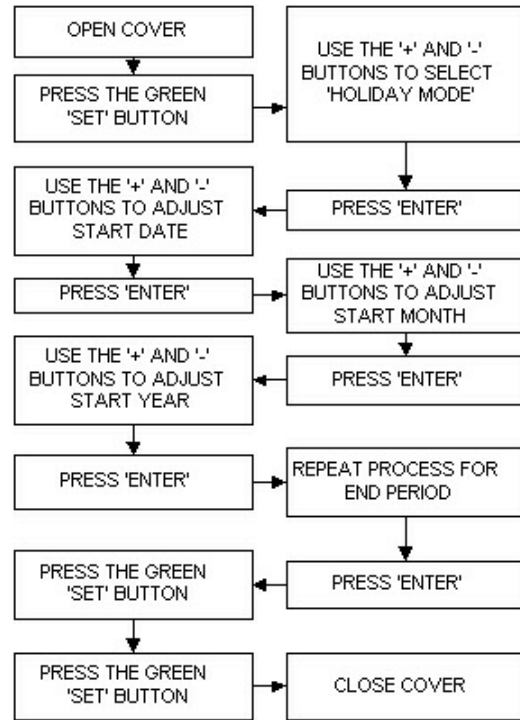

SAMPLE DISPLAYS



PROGRAMME OVERRIDE FACILITIES

With the ChannelPlus H17XL Series 2 timeswitch operating in the normal running mode it is possible to alter the functionality of the programme on each individual channel. The options include; **Auto** - Timeswitch follows all programmed 'ON' and 'OFF' times.

All day - Timeswitch operates from 1st 'ON' time until 3rd 'OFF', ignoring all switching times in between. Useful for unexpected times of occupation or to maintain a constant temperature during an extended period.

On - Timeswitch will be constantly 'ON'.

Off - Timeswitch will be constantly 'OFF', ability to turn off the programme during summer without altering the programme times.

All of the settings above will be permanent, i.e. unaffected by programme times, until the programme is altered by the user

The diagram below illustrates how to alter the setting, it assumes that the timeswitch is in the AUTO mode to begin with.

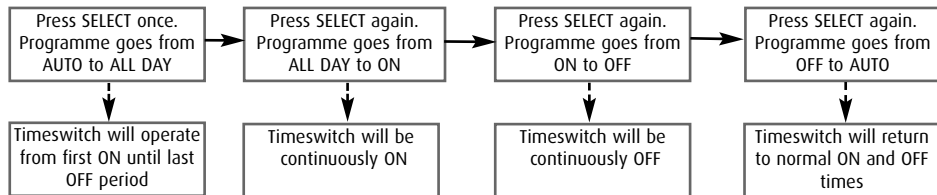

ADJUSTING TIME AND DATE - SEE NOTE BELOW

The ChannelPlus H17XL Series 2 timeswitch has been preset with the current time and date during manufacture. No alteration should be required to the time and date, however if any modification is required please refer to the flowchart below.

PLEASE NOTE; Any alteration to the current time or date will cancel any Holiday programme set. It will also cause any Boost or Advance operations to be cancelled.

SAMPLE DISPLAYS

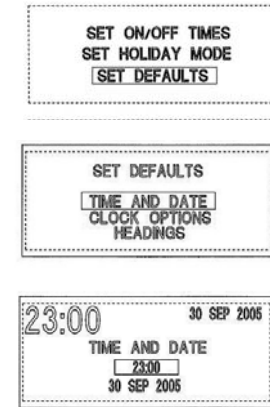
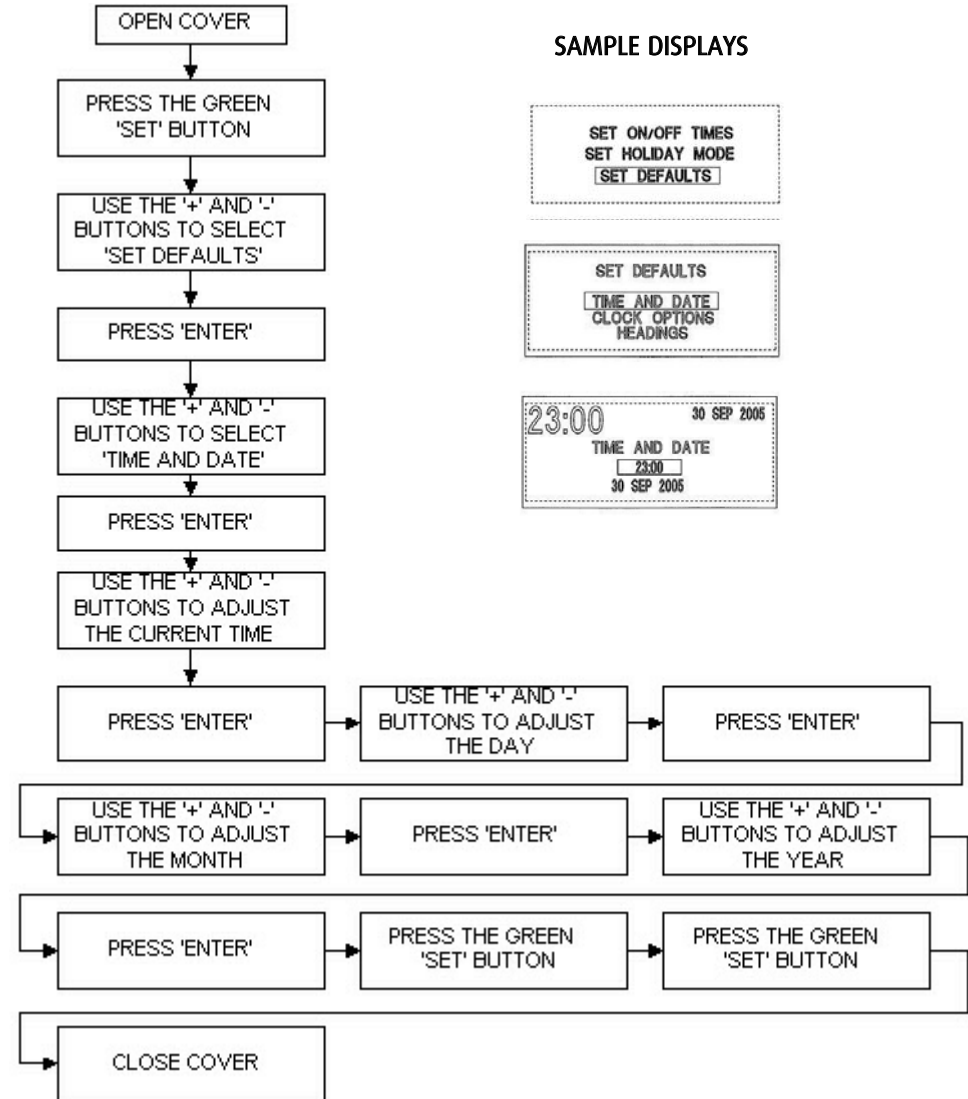

ADJUSTING CLOCK OPTIONS

The timeswitch has been preset to display the time in 24 hour clock format, should you prefer an AM/PM display then please follow the flowchart opposite.

SAMPLE DISPLAYS

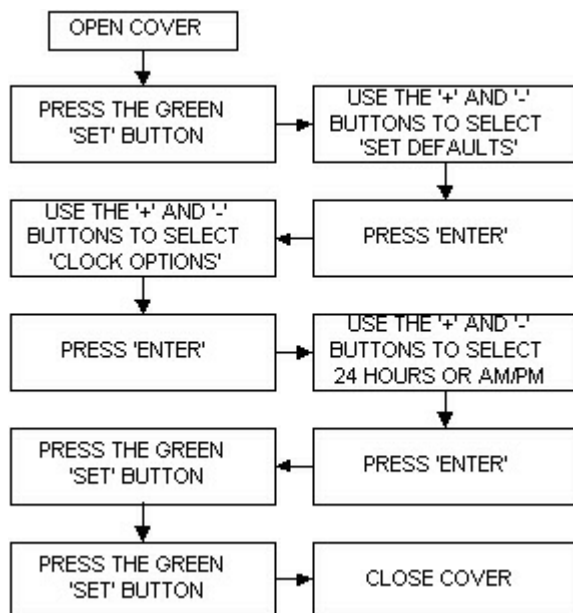
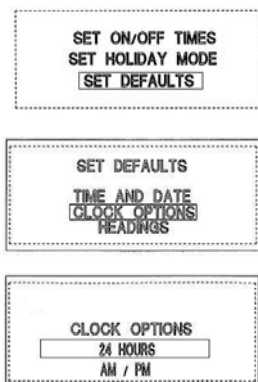

ADJUSTING CHANNEL HEADINGS

The timeswitch has been preset without a channel heading on the display. If you require either the 'Water' or 'Heating' options then please follow the flowchart opposite.

SAMPLE DISPLAYS

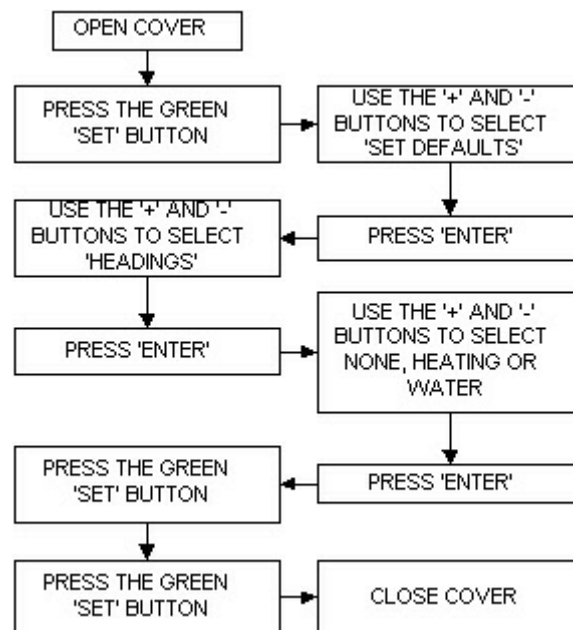
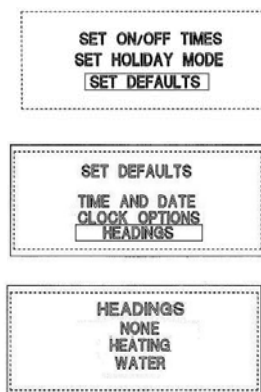

SETTING THE PROGRAMME TIMES

The programme times have been pre-set as shown in the chart below, if any changes are required to the programme times please make adjustments as described in the flowchart below.

	DEFAULT TIME SETTINGS					
	1st ON	1st OFF	2nd ON	2nd OFF	3rd ON	3rd OFF
MON-FRI	6:30 AM	8:30 AM	12:00 PM	12:00 PM	4:30 PM	10:30 PM
SAT/SUN	7:30 AM	10:30 AM	12:00 PM	12:00 PM	5:00 PM	11:00 PM

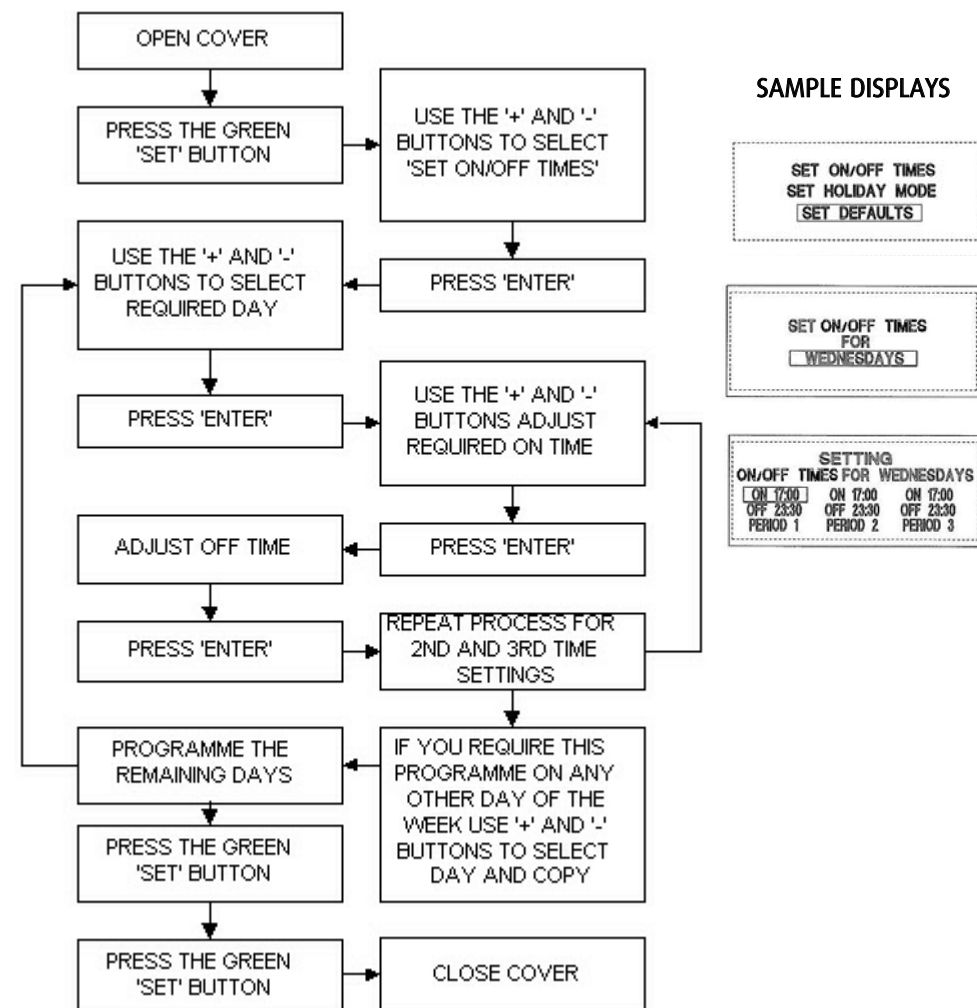

SAMPLE DISPLAYS

