

GOBO STARWASH

Item ref: 151.606UK

3-in-1 Light Effect

User Manual

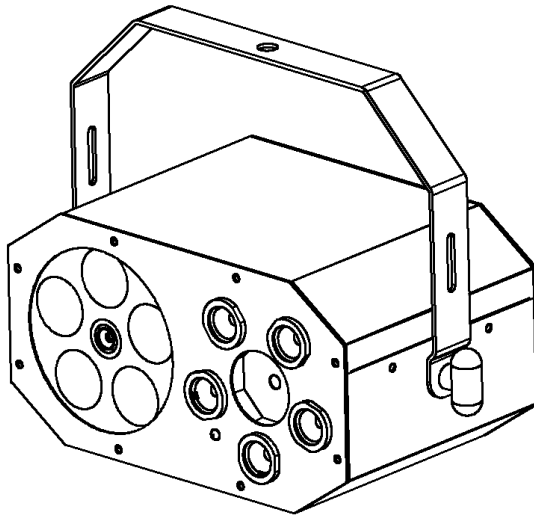

Version 1.0



Caution: Please read this manual carefully before operating
Damage caused by misuse is not covered by the warranty

Introduction

Thank you for choosing the GOBO STARWASH as part of your light show. This compact light effect unit is a complete lighting effects solution in a single fixture with LED Moonflower, Colour Wash and Laser functions, all controllable from internal programs or remote control. Please read and keep the following instructions for future reference.

SAFETY SYMBOL AND MESSAGE CONVENTIONS



CAUTION
RISK OF ELECTRIC SHOCK
DO NOT OPEN

AVIS
RISQUE DE CHOC ELECTRIQUE NE PAS
OUVRIR



This symbol indicates that dangerous voltage constituting a risk of electric shock is present within this unit



This symbol indicates that there are important operating and maintenance instructions in the literature accompanying this unit.

Warning

To prevent the risk of fire or electric shock, do not expose any components to moisture. If liquids are spilled on the housing, stop using immediately, allow unit to dry out and have checked by qualified personnel before further use. Avoid impact, pressure or heavy vibration to the case. No user serviceable parts inside – Do not open the case – refer all servicing to qualified service personnel.

Safety

Check for correct mains voltage and condition of IEC lead before connecting to a power outlet. Do not allow any foreign objects to enter the case or connectors.

Placement

- Keep away from damp or dusty environments
- Use the included tripod stand for installation onto a stable surface
- Ensure adequate air-flow around the fixture housings
- Ensure adequate access to controls and connections

Caution: Laser radiation

Avoid pointing directly towards eyes. Laser output can cause injury if viewed directly. This product is a Class 3B laser and should only be installed and used by personal who are trained in the management of laser radiation and are able to operate in accordance within the guidance given by the Health and Safety Executive (HSE) in HS(G)95: "The Radiation Safety of Lasers used for Display purposes".

Copies of this guide can be downloaded from www.avsl.com/assets/documents/hsg95.pdf



Cleaning

- Use a soft cloth with a neutral detergent to clean the casing as required
- Use a vacuum cleaner to clear ventilation grilles of any dust or debris build-ups
- Do not use strong solvents for cleaning the unit

In the box

Please open the package carefully and check that all contents are present and in good condition.

Contact your retailer if any part is missing or broken.

- GOBO STARWASH light effect unit
- Mounting bracket
- IR remote control
- IEC mains lead(s)
- Laser switch key

Rear panel

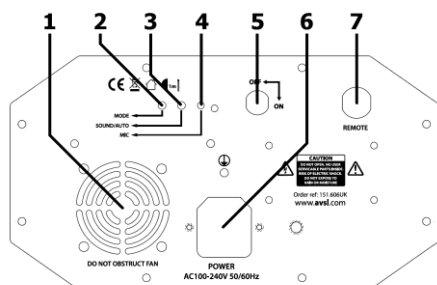

- 1 Cooling vent
- 2 Mode button (selects program)
- 3 Sound / Auto button
- 4 Internal microphone
- 5 Laser safety key switch
- 6 Mains power inlet & fuse holder
- 7 Remote laser safety switch connector

Operation

Using the Mode and Sound/Auto buttons, the GOBO STARWASH can be set to various modes.

Press the MODE button (2) to step through the internal programs. Gobo projector, Colour wash, Laser show or all 3 together.

Press the Sound / Auto button (3) to toggle between sound-activated or auto control of the selected mode.

For safety, the laser effect is activated by a key switch (5) and a remote 2-pin connector (7). The key switch must be set to on and the supplied 2-pin plug connected for the laser effect to operate.

The 2-pin plug has both pins shorted and can be wired as a remote laser defeat switch if needed.

Internal programs can also be selected via the included IR remote control as shown below.

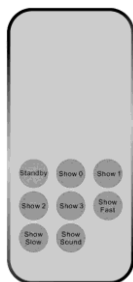

As supplied, the remote handset has a clear plastic tab inserted which should be removed to activate the CR2025 button cell. Point the handset toward the front of the GOBO STARWASH unit at a range of no more than 5m for remote control.

Standby	Temporarily disables light output
Show 0 – Show 3	Select internal show mode
Show Fast	Select fast speed for selected show
Show Slow	Select slow speed for selected show
Show Sound	Toggle between sound-activated or auto

Specifications

Power supply	100-240Vac, 50/60Hz
Fuse	F2AL 250V (5 x 20mm)
Power consumption	24W
LEDs : gobos	5 x 3W (R/G/B/W/Y)
LEDs : wash	5 x 1W (R/G/B/W/Y)
Laser	100mW red (650nm) + 30mW green (532nm)
Operating temperature	40°C max.
Dimensions	170 x 160 x 122mm
Weight	1.9kg

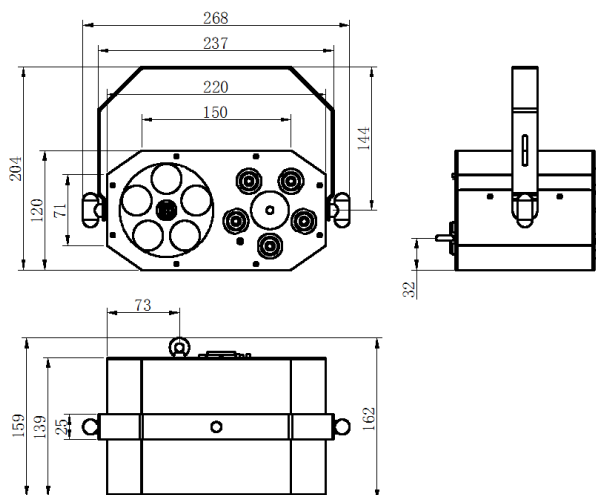

Disposal: The "Crossed Wheelie Bin" symbol on the product means that the product is classed as Electrical or Electronic equipment and should not be disposed with other household or commercial waste at the end of its useful life. The goods must be disposed of according to your local council guidelines.

*Errors and omissions excepted.
Copyright© 2017. AVSL Group Ltd.*