

PCC9120SS
90cm Multi-function
cooking theatre

Instruction manual

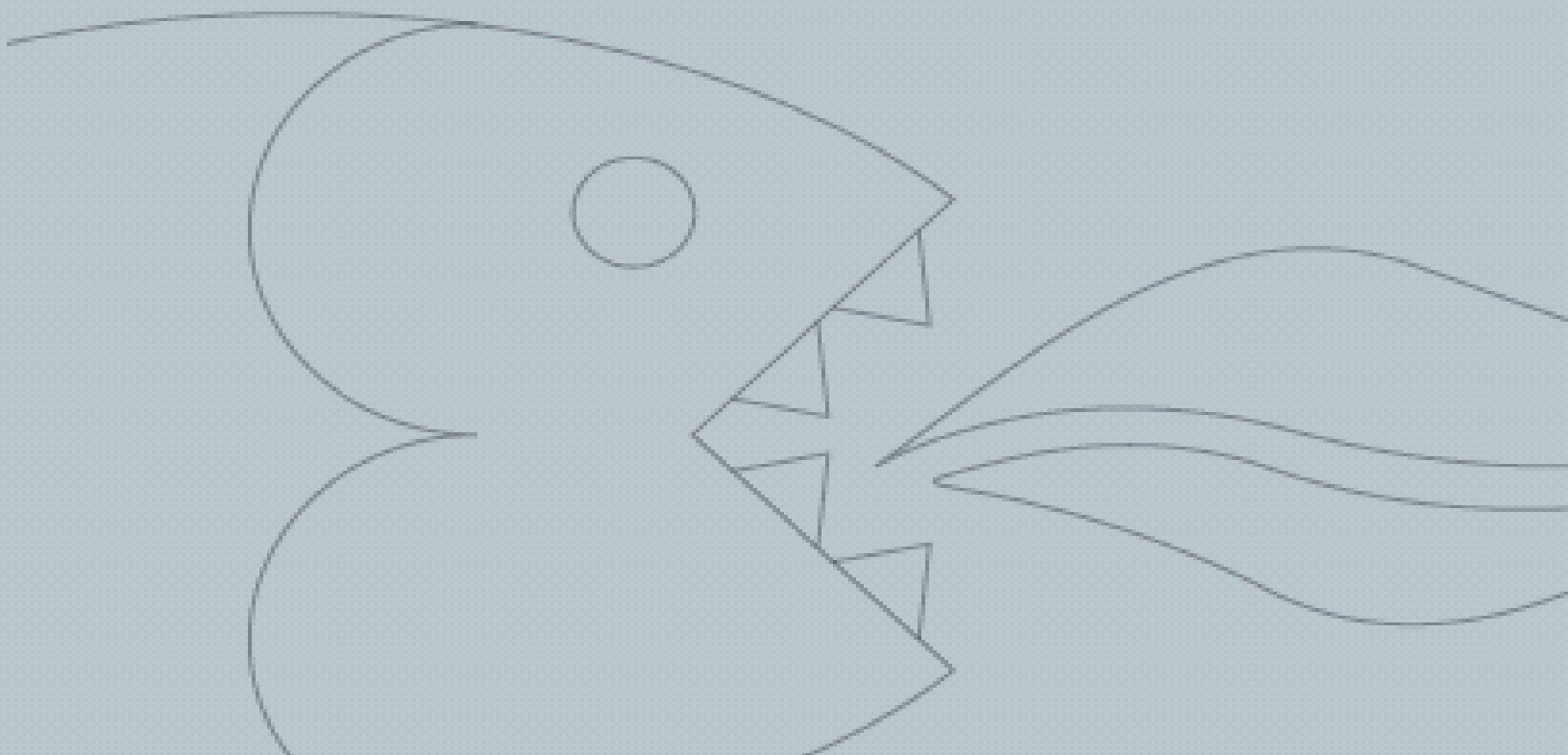

User Manual for your Baumatic

PCC9120SS

90 cm Multi-function cooking theatre



You will be mine ...

NOTE: This User Instruction Manual contains important information, including safety & installation points, which will enable you to get the most out of your appliance. Please keep it in a safe place so that it is easily available for future reference; for you or any person not familiar with the operation of the appliance.

DD 15/11/07

Contents

| | |
|---|---------|
| Environmental note | 4 |
| Important safety information | 5 – 9 |
| Specifications | 9 – 10 |
| Thermostat control knob | 11 |
| Oven function selector knob | 11 |
| Oven programmer/timer | 11 |
| Oven programmer/timer display | 11 |
| Setting and using the oven programmer/timer | 12 - 16 |
| Selecting manual operation mode | 12 |
| Setting the time of day | 12 |
| Setting the minute minder function | 13 |
| Setting the duration function | 14 |
| Setting the end cook function | 15 |
| Setting the start and end time function | 16 |
| Selecting a cooking function and temperature | 17 - 20 |
| Selecting manual operation mode | 17 |
| Before first use | 17 |
| Selecting an oven function | 17 |
| Cooking functions | 18 |
| Thermostat control knob | 19 |
| Oven operating light | 19 |
| Cooking guidelines | 19 - 20 |
| Warnings | 19 – 20 |
| Using the hob top | 20 - 21 |
| Automatic electric ignition | 21 |
| Energy saving tips | 21 |
| Cleaning and maintenance | 22 - 25 |
| Cleaning the hob burners | 23 |
| Replacing the oven bulb | 23 |
| Removing the oven door for cleaning | 24 |
| Removing the inner door glass for cleaning | 25 - 26 |
| Installation | 26 - 36 |
| Positioning | 26 – 28 |
| Gas connection | 28 - 29 |
| Ventilation requirements | 29 |
| Gas Safety (Installation and Use) Regulations | 30 |
| Gas connection | 30 - 31 |
| Gas adjustment (Conversion to LPG) | 31 - 32 |
| Minimum flow adjustment for hob gas taps | 33 |
| Fitting a stability chain | 34 |
| Electrical connection | 35 |
| Connecting the main supply cable | 35 – 36 |
| Replacing the mains supply cable | 36 |
| My appliance isn't working correctly | 37 – 38 |
| Contact details | 39 |

This appliance is marked according to the European directive 2002/96/EC on Waste electrical and Electronic Equipment (WEEE). By ensuring this product is disposed of correctly, you will help prevent potential negative consequences for the environment and human health, which could otherwise be caused by inappropriate waste handling of this product.

The symbol  on the product, or on the documents accompanying the product, indicates that this appliance may not be treated as household waste. Instead it shall be handed over to the applicable collection point for the recycling of electrical and electronic equipment.

Disposal must be carried out in accordance with local environmental regulations for waste disposal.

For more detailed information about treatment, recovery and recycling of this product, please contact your local city office, your household waste disposal service or the shop where you purchased the product.



- The packaging materials that Baumatic uses are environmentally friendly and can be recycled.
- Please discard all packaging material with due regard for the environment.

Important safety information



Your safety is of the utmost importance to Baumatic. Please make sure that you read this instruction booklet **before** attempting to install or use the appliance. If you are unsure of any of the information contained in this booklet, please contact the Baumatic Technical Department.

General Information

- This appliance is designed for domestic household use and for the cooking of domestic foodstuffs.
- **IMPORTANT:** The adjacent furniture and all materials used in the installation **must** be able to withstand a minimum temperature of 85°C above the ambient temperature of the room it is located in, whilst in use.
- Certain types of vinyl or laminate kitchen furniture are particularly prone to heat damage or discolouration at temperatures below the guidelines given above.
- Any damage caused by the appliance being installed in contravention of this temperature limit, or by placing adjacent cabinet materials closer than 20 mm to the appliance, **will be the liability of the owner.**
- For use in **leisure accommodation vehicles**, please refer to the appropriate information given in the installation instructions for this appliance.
- **IMPORTANT:** Baumatic Ltd. **DO NOT** recommend that this appliance is installed on any type of marine vessel.
- The use of this appliance for any other purpose or in any other environment without the express agreement of Baumatic Ltd. will invalidate any warranty or liability claim.
- Your new appliance is guaranteed against electrical or mechanical defects, subject to certain exclusions that are noted in Baumatic's Conditions Of Guarantee. The foregoing does not affect your statutory rights.
- **Repairs may only be carried out by Baumatic Service Engineers or their authorised service agent.**

Warning and safety instructions

- This appliance complies with all current European safety legislation. Baumatic do wish to emphasise that this compliance does not remove the fact that the appliance surfaces **will become hot during use and retain heat after operation.**

Child Safety

- Baumatic strongly recommend that babies and young children are prevented from being near to the appliance and not allowed to touch the appliance **at any time**. During and after use, all surfaces will become hot.
- If it is necessary for younger family members to be in the kitchen, please ensure that they are kept under close supervision at all times.

General Safety

- ✓ Make sure that you understand the controls before using the appliance.
- ✓ Check that all of the controls on the appliance are turned off after use.
- ✓ Always stand back when opening the oven door, this will allow heat to disperse.
- ✓ Take care when removing items from the oven, as the contents may be hot.
- ✓ Always keep the oven doors closed when the oven is not in use.
- ✓ Always follow the basic principles of food handling and hygiene, this will prevent the possibility of bacterial growth.
- ✓ Always keep ventilation slots clear of obstructions.
- ✓ Keep fingers away from the hinge areas when closing the door, otherwise you may trap them.
- ✓ Oven gloves should be used when placing food in the oven cavity and when removing it. Care should be taken to avoid direct contact with any of the elements in the appliance.
- **DO NOT LEAVE THE APPLIANCE UNATTENDED WHILST IN USE.**

- **Do not** place heavy objects on the oven door or lean on the oven door when it is open, as this can cause damage to the oven door hinges. Nobody should be allowed to sit or stand on any part of the cooker.
- **Do not** store chemicals, food stuffs, pressurised containers in or on the cooker or in cabinets immediately above or next to the cooker.
- **Do not** heat up unopened food containers, as pressure can build up which may cause the container to burst.
- **Do not** place flammable or plastic items on or near the hob burners, these types of materials should also not be placed in the oven or the compartment below the oven.
- **Do not** leave heated oil or fat unattended, as this is a fire risk. You should not fill a deep fat frying pan more than one third full of fat or oil, you should also not use a lid.
- **Do not** allow fat or oil to build up in the oven trays, grill pan or oven base.
- **Do not** place pans or baking trays directly on the base of the oven cavity, or line it with aluminium foil.
- **Do not** grill food containing fat without using the grill trivet. The grill trivet should never be covered with aluminium foil.
- **Do not** place hot enamel parts in water, leave them to cool first.
- **Do not** allow vinegar, coffee, milk, saltwater, lemon, tomato juice or any liquid with high sugar content to remain in contact with the enamel parts of the appliance. Spillages should be wiped up immediately.
- **Do not** allow electrical fittings or cables to come into contact with areas on the appliance that get hot.
- **Do not** use the appliance to heat the room it is located in or to dry clothing. No clothing should be placed over or near to the hob burners or oven door.
- **Do not** install the appliance next to curtains or soft furnishings.

- **Do not** attempt to lift or move cooking appliances by using the oven door or handle, as this may cause damage to the appliance or result in injury to the person lifting the appliance.

Cleaning

- Cleaning of the oven should be carried out on a regular basis.
- Great care should be taken whilst using this appliance and when following the cleaning procedure.
- **IMPORTANT:** The appliance must be disconnected from the mains before following the cleaning procedure.
- **IMPORTANT: Care must be taken when cleaning between the door glasses, and inside the inner frame as some of the edges maybe sharp due to the manufacturing process.**

Installation



This appliance must be correctly installed by a suitably qualified person, strictly in accordance with the manufacturer's instructions. Please see the specific section of this booklet that refers to installation.

- **Baumatic Ltd. declines any responsibility for injury or damage, to person or property, as a result of improper use or installation of this appliance.**
- Heat, steam and moisture will be created during use of the appliance, take care to avoid injury and ensure that the room is adequately ventilated. If the appliance is going to be used for prolonged periods of time, then additional ventilation may be required.
- Please consult with your qualified installer if you are in any doubt about the amount of ventilation that you will require.

Declaration of conformity

This appliance complies with the following European Directives:

- 73/23/EEC regarding "low voltage"
- 89/336/EEC regarding "electromagnetic disturbances"
- 90/396/EEC regarding "gas appliances"
- 89/109/EEC regarding "materials in contact with food".

- The above directives comply with 93/68/EEC regarding CE marking.
- The manufacturer declares that the oven is built using certified materials and requires the appliance to be installed in accordance with the standards currently in force. This appliance must be used by a trained person for domestic purposes only.

Specifications

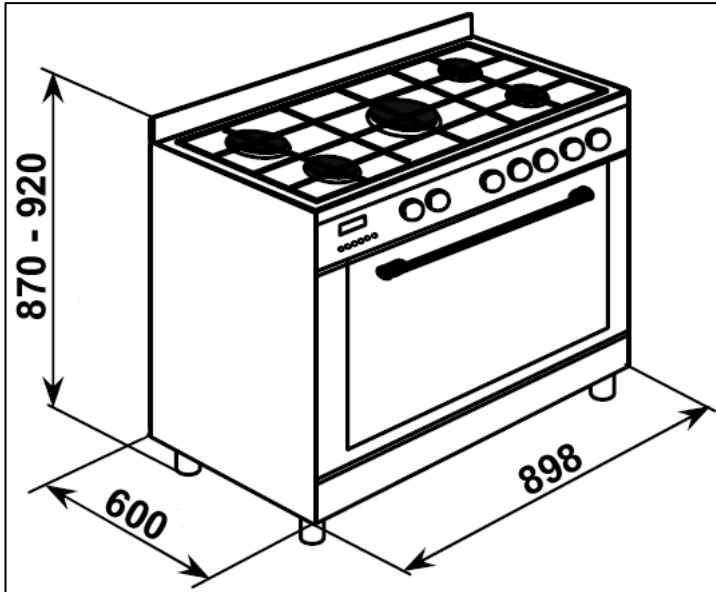

Product dimensions:

Height: 870 - 920 mm

Width: 898 mm

Depth: 600 mm

Product specifications:

- **5 burner gas hob:**
 - 1 x 3.60 kW wok burner
 - 1 x 3.00 kW rapid burner
 - 2 x 1.75 kW semi-rapid burners
 - 1 x 1.00 kW auxillary burner
 - Heavy duty cast iron pan stands
 - Underknob auto-ignition
- 8 function oven
- Oven energy efficiency class: B
- Oven capacity: 107 litres
- Storage compartment capacity: 35 litres
- LED fully programmable timer
- Cooling fan
- Thermostatically controlled grill
- Double glazed removable door
- Adjustable feet

Standard accessories:

- Wok stand
- Removable side racks
- 2 x safety shelves
- Enamelled drip tray
- Trivet
- LPG conversion jets

Optional extras:

- BPS1 Pizza stone
- BTGRID Double-sided griddle plate

Electrical details

| | |
|---------------------------|---|
| Rated Voltage: | 230 Vac 50 Hz |
| Supply Connection: | 13 A (double pole switched fused outlet with 3mm contact gap) |
| Max Rated Inputs: | 2.46 kW |
| Mains Supply Lead: | 3 core x 1.5mm ² |
| Oven Light Bulb: | E14 25 W/300°C screw type pigmy |

Gas details

| | |
|--------------------------------|--|
| Gas Connection Type: | 1/2" BSP |
| Gas Type (Natural Gas): | 20 mbar |
| Gas Type (LPG): | See table on page 31 for this information. |

For future reference please record the following information which can be found on the rating plate and the date of purchase which can be found on your sales invoice. The rating plate for your oven can be located by opening the door of the storage compartment.

Model Number

Serial Number

Date of Purchase

Control Panel

Thermostat control knob

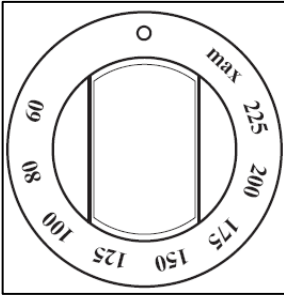

- Use this control knob to control the temperature in the oven.

Oven function selector knob

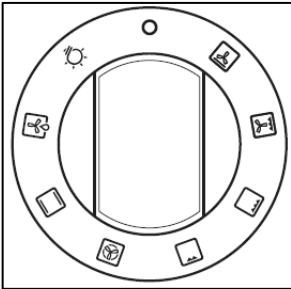

- Use this control knob to select the oven function and turn on the oven light.

Oven programmer/timer

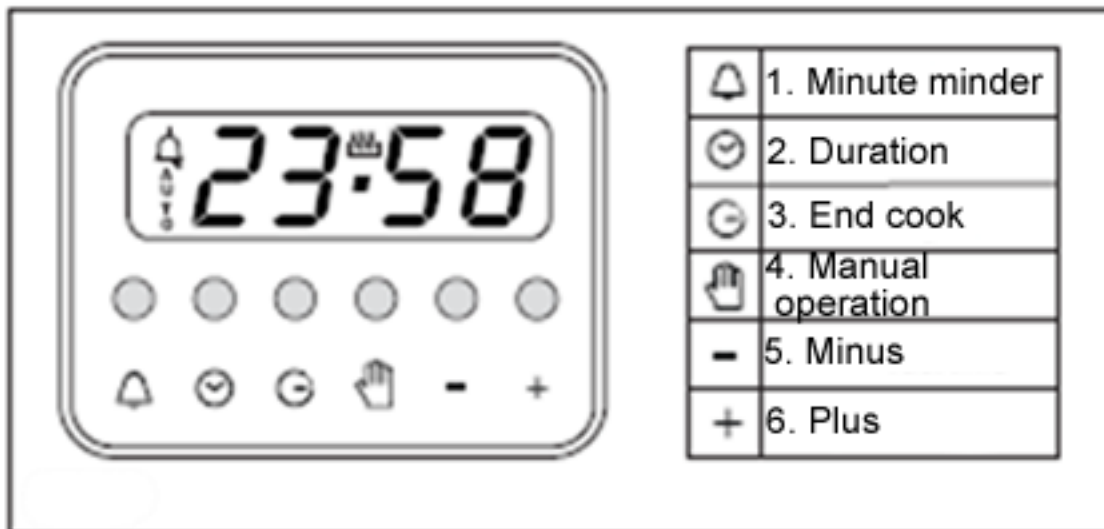

Oven programmer/timer display

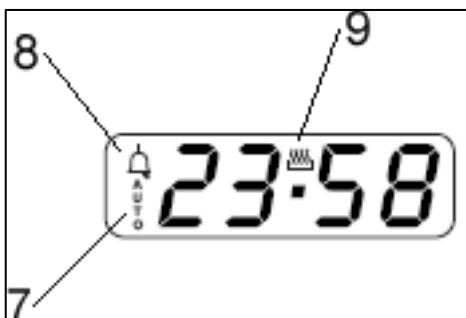

- 7) "Auto" function symbol
- 8) "Minute minder" symbol
- 9) "Manual operation" symbol.

Setting and using the oven programmer/timer

Selecting manual operation mode

After your appliance is connected to your mains supply for the first time, the numbers on the timer display will flash. Before you can select a cooking function or set a temperature, you must set the appliance into “manual operation” mode.

- To select manual operation mode, press the “manual operation” button **(4)** on the control panel.

Setting the time of day

After setting your oven for manual operation, you should also set the time of day.

- Use the “minus” button **(5)** and “plus” button **(6)** to adjust the time that appears in the display. After getting the display to the correct time, release the “minus” and “plus” buttons. After a few seconds the time will fix in the display and you will be able to use your oven.

Setting the minute minder function

You are able to set the minute minder at any time, regardless of whether an oven function has been selected. You can set a period of time using the minute minder function and an alarm will sound when this period of time has elapsed.

- Press the “minute minder” button **(1)**, the display will show a value of 00:00. Set the period of time that you wish the minute minder to countdown for, by using the “minus” **(5)** and “plus” **(6)** buttons.
- Once the display has got to your desired countdown time, let go of the “minus” and “plus” buttons. The minute minder symbol **(8)** will appear on the timer display.
- Once a countdown time has been set, it is possible to shorten or lengthen the time by using the “minus” **(5)** or “plus” **(6)** buttons.
- An alarm will sound when the countdown time has elapsed. The alarm can be silenced by pressing the “minute minder” button **(1)**.
- **Important:** The oven will continue to heat once the alarm has been silenced. If you have finished cooking, then you should turn the oven function selector and thermostat control knob to 0.

Setting the duration function

This function will allow you to set a countdown time similar to the minute minder function. However the oven will no longer continue to heat, once the countdown period has elapsed.

- Use the thermostat control knob to set the temperature that you require. The manual operation symbol **(9)** will appear on the display.
- Use the oven function selector knob to select the mode of cooking that you require.
- It is then possible to set the duration of the cooking time that you require.
- Press the "duration" button **(2)** and the display will show a value of 00:00. Set the period of time that you wish the duration function to countdown for, by using the "minus" **(5)** and "plus" **(6)** buttons.
- Once the display has got to your desired countdown time, let go of the "minus" and "plus" buttons. The countdown will start immediately and the word AUTO **(7)** will appear on the timer display.
- Once a countdown time has been set, it is possible to shorten or lengthen the time by using the "minus" or "plus" buttons.
- An alarm will sound when the countdown time has elapsed and the oven will switch off. The word AUTO will flash and the heating symbol will disappear. The alarm can be silenced by pressing the "duration" button **(2)**.
- You will need to return the oven to manual operation mode, once the duration function has been used. To do this you should press the "manual operation" button **(4)**, the word AUTO will disappear from the display and the manual operation symbol will appear instead.
- **Important:** If you do not turn the thermostat control knob and oven function selector knob to 0. Then the appliance will continue to operate as soon as you press the "manual operation" button.

Setting the end cook function

This function is similar to the duration function, however instead of selecting a period of time that you wish the oven to switch off after. You select the time of day that you wish the oven to switch off at.

- Use the thermostat control knob to set the temperature that you require. The manual operation symbol **(9)** will appear on the display.
- Use the oven function selector knob to select the mode of cooking that you require.
- Press the “end cook” button **(3)** and the display will show a value of 00:00. Set the time of day that you wish the oven to stop cooking at by using the “minus” **(5)** and “plus” **(6)** buttons. The timer will calculate how long the cooking time will be, based on the time of day that you have selected and show it on the display.
- Once the display has got to the time of day that you want the oven to stop cooking at, let go of the “minus” and “plus” buttons. The countdown will start immediately and the word AUTO **(7)** will appear on the timer display.
- When the time is set, it can be modified by pressing the “minus” and “plus” buttons.
- When the time of day reaches the end of cooking time that you set, the oven will switch off and an alarm will sound. The word AUTO will flash and the heating symbol will disappear. The alarm can be silenced by pressing the “end cook” button.
- You will need to return the oven to manual operation mode, once the end cook function has been used. To do this you should press the “manual operation” button **(4)**, the word AUTO will disappear from the display and the manual operation symbol will appear instead.
- **Important:** If you do not turn the thermostat control knob and oven function selector knob to 0. Then the appliance will continue to operate as soon as you press the “manual operation” button.

Setting the start and end time function

This function will allow you to set a time in the future that the oven switches on at and a time that the oven will switch off at.

- Use the thermostat control knob to set the temperature that you require. The manual operation symbol **(9)** will appear on the display.
- Use the oven function selector knob to select the mode of cooking that you require.
- Press the “duration” button **(2)** and the display will show a value of 00:00. Set the period of time that you wish to cook for, by using the “minus” **(5)** and “plus” **(6)** buttons. The word AUTO **(7)** will appear on the timer display.
- **Immediately** press the “end cook” button **(3)** and the timer display will show a value of 00:00. Set the time of day that you want the oven to switch off at, using the “minus” **(5)** and “plus” **(6)** buttons.
- The oven will calculate what time it needs to switch on at, so that your food will cook for the length of time that you selected. It will automatically switch itself on, once it reaches the time of day that it has calculated.
- When the time of day reaches the end of cooking time that you set, the oven will switch off and an alarm will sound. The word AUTO will flash and the heating symbol will disappear. The alarm can be silenced by pressing the “end cook” **(3)** or “duration” button **(2)**.
- You will need to return the oven to manual operation mode, once the start and end time function has been used. To do this you should press the “manual operation” button **(4)**, the word AUTO will disappear from the display and the manual operation symbol will appear instead.
- **Important:** If you do not turn the thermostat control knob and oven function selector knob to 0. Then the appliance will continue to operate as soon as you press the “manual operation” button.

Selecting a cooking function and temperature

Selecting manual operation mode

After your appliance is connected to your mains supply for the first time, the numbers on the timer display will flash. Before you can select a cooking function or set a temperature, you must set the appliance into “manual operation” mode.

- To select manual operation mode, press the “manual operation” button **(4)** on the timer.

Before first use

- To remove any residue from the oven that may have been left from the manufacturing process, you should select either the fan or conventional oven function and turn the thermostat dial to its maximum setting.
- It is perfectly normal for a smell to be produced during this process.
- You should make sure that any windows in the room are left open during this process.
- It is advisable for you not to remain in the room whilst the burning off process is taking place.
- You should leave the oven on maximum setting for 30 – 40 minutes.

Selecting an oven function

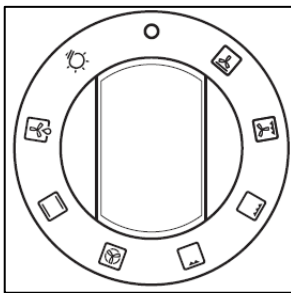

The main oven function selector knob should be turned clockwise and used to select the particular mode of cooking that you require. The appliance will utilise different elements within the oven cavity, depending on the oven function that you select. When a function is selected, the power indicator light will come on.

There are eight cooking functions available on your appliance:



OVEN LIGHT: Separate light control which allows the light to be switched on, even when the oven is not heating.



DEFROST MODE: The fan runs without heat to reduce the defrosting time of frozen foods. The time required to defrost the food will depend on the room temperature, the quantity and type of food. Always check food packaging for the defrosting instructions.



CONVENTIONAL OVEN (top and lower element): This method of cooking provides traditional cooking, with heat from the top and lower elements. This function is suitable for roasting and baking on one shelf only.



FAN OVEN: This method of cooking uses the circular element while the heat is distributed by the fan. This results in a faster and more economical cooking process. The fan oven allows food to be cooked simultaneously on different shelves, preventing the transmission of smells and tastes from one dish onto another.



HALF GRILL: This method of cooking utilises the inner part only of the top element, which directs heat downwards onto the food. This function is suitable for grilling small portions of bacon, toast and meat etc. The thermostat control knob must be turned to its maximum setting.



FULL GRILL: This method of cooking utilises the inner and outer parts of the top element, which directs heat downwards onto the food. This function is suitable for grilling medium or large portions of sausages, bacon, steaks, fish etc. Ideally the thermostat control knob should be set to 200°C



FAN AND GRILL: This method of cooking utilises the top element in conjunction with the fan, which helps to provide a quick circulation of heat. This function is suitable where quick browning is required and "sealing" the juices in, such as steaks, hamburgers, some vegetables etc.



FAN AND LOWER ELEMENT: This method of cooking utilises the bottom element in conjunction with the fan, which helps to circulate the heat. This function is suitable for sterilising and preserving jars.

Thermostat control knob (main oven)

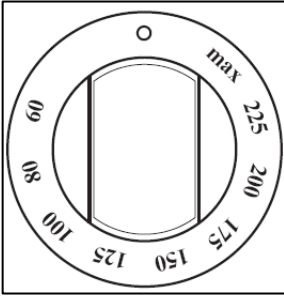

The oven thermostat control knob should be turned clockwise and it sets the required temperature of the oven. It is possible to regulate the temperature within a range of 60 - 250°C.

Oven operating light

This light will come on to indicate that the oven's heating elements are in operation. The light will turn off when the temperature set on the thermostat control knob has been reached. It will cycle on and off throughout the cooking time.

You should not place food inside the cavity, until the correct cooking temperature has been reached.

Cooking guidelines

- Please refer to the information given on food packaging for guidance on cooking temperatures and times. Once familiar with the performance of your appliance, temperatures and times can be varied to suit personal preference.
- If you are using the fan oven function, then you should follow the information given on the food packaging for this particular mode of cooking.
- Make sure that frozen foods are thoroughly thawed before cooking, unless the instructions on the food packaging advise that you can "cook from frozen".
- You should pre-heat the oven and not place food inside of it until the oven operating light has gone off. You can choose not to pre-heat when using the fan oven mode; however you should extend the cooking time given on the food packaging by approximately ten minutes.
- Before cooking, check that any unused accessories are removed from the oven.
- Place cooking trays in the centre of the oven and leave gaps between the trays to allow air to circulate.
- Try to open the door as little as possible to view the dishes.

- The oven light will remain on during cooking.

Warnings

- Keep the oven door closed when using any of the grill or oven functions.
- Do not use aluminium foil to cover the grill pan or heat items wrapped in aluminium foil under the grill. The high reflectivity of the foil could potentially damage the grill element.
- You should never line the base of your oven with aluminium foil.
- During cooking, never place pans or cookware directly onto the bottom of the oven. They should always be placed on the shelves provided.
- The grill heating element becomes extremely hot during operation, avoid touching it inadvertently when handling the food which you are grilling.
- **Important:** Be careful when opening the door, to avoid contact with hot parts and steam.
- **IMPORTANT:** In case of fire, close the main valve of the gas supply and switch off the electricity supply to the appliance. **NEVER** pour water onto burning oil.

Using the hob top

The following symbols will appear on the control panel, next to each control knob:



Black circle: gas off

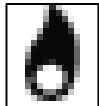

Large flame: maximum setting



Small flame: minimum setting

- The minimum setting is at the end of the anti-clockwise rotation of the control knob.
- All operation positions must be selected between the maximum and minimum positions.

- Never select a knob position between the maximum and off position.

Automatic electric ignition

To ignite a burner:

- Press in the control knob of the burner that you wish to light and turn it clockwise to the maximum position.
- If you keep the control knob depressed, the automatic ignition for the burner will operate.
- In case of power failure, the burners can be lit by carefully using a match.

Energy saving tips

| BURNERS | Pan size | |
|------------|----------|-------|
| | Ø min. | Ø max |
| Auxiliary | 120 | 140 |
| Semi-rapid | 160 | 200 |
| Rapid | 200 | 240 |
| Wok | 240 | 280 |

- The diameter of the bottom of the pan should correspond to that of the burner.

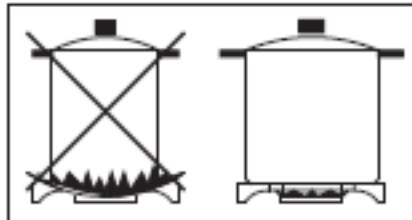

- The burner flame must never extend beyond the diameter of the pan.
- Use flat bottomed pans only
- When possible, keep a lid on the pan whilst cooking.
- Cook vegetables with as little water as possible, to reduce cooking times.

IMPORTANT: Always place pans centrally over the hob burners and position them so that the handles cannot get accidentally caught or knocked off. You should also make sure that the handle is not over one of the other hob burner flames.



Cleaning operations must only be carried out when the oven is cool.

The appliance should be disconnected from your mains supply before commencing any cleaning process.

- The oven should be thoroughly cleaned before it is operated for the first time and after each use. This will avoid residual food stuffs becoming baked on the oven cavity. After residues have been baked on several times, they are far more difficult to remove.
- **Never** clean the oven surfaces by steam cleaning.
- The oven cavity should only be cleaned with warm soapy water, using either a sponge or soft cloth. No abrasive cleaners should be used.
- Any stains that may appear on the bottom of the oven will have originated from food splashes or spilt food, these splashes occur during the cooking process. These could possibly be a result of the food being cooked at an excessively high temperature or being placed in cookware that is too small.
- You should select a cooking temperature and function that is appropriate for the food that you are cooking. You should also ensure that the food is placed in an adequately sized dish and that you use the drip tray where appropriate.
- Outer parts of the oven should only be cleaned with warm soapy water, using either a sponge or soft cloth. No abrasive cleaners should be used.
- If you use any form of oven cleaner on your appliance, then you must check with the manufacturer of the cleaner that it is suitable for use on your appliance.
- **Any damage that is caused to the appliance by a cleaning product will not be fixed by Baumatic free of charge, even if the appliance is within the guarantee period.**

Cleaning the hob burners

The hob burners should be cleaned once a week or more frequently if they get soiled.

- Remove the hob burners by pulling them upwards and away from the hob top.
- Soak them for about ten minutes in hot water and a little detergent.
- After cleaning and washing them, wipe and dry them carefully.
- Before placing the burners back on the hob top, **make sure that the gas jet is not blocked.**
- **IMPORTANT:** Make sure that you reassemble the burners in the original way.

Replacing the oven bulb



IMPORTANT: The oven must be disconnected from your mains supply before you attempt to either remove or replace the oven bulb.

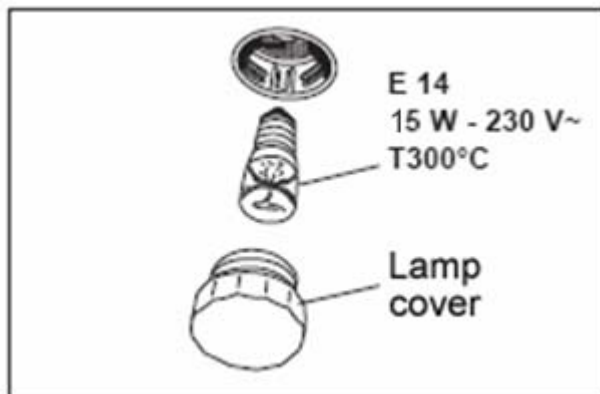

- Remove all oven shelves and the drip tray.
- Unscrew the lamp cover.
- Unscrew the bulb and remove it from its holder.
- Replace the bulb with a 15 W/300°C, screw type pigmy.
- **Do not** use any other type of bulb.
- Screw the lamp cover back into its original position.

Removing the oven door for cleaning

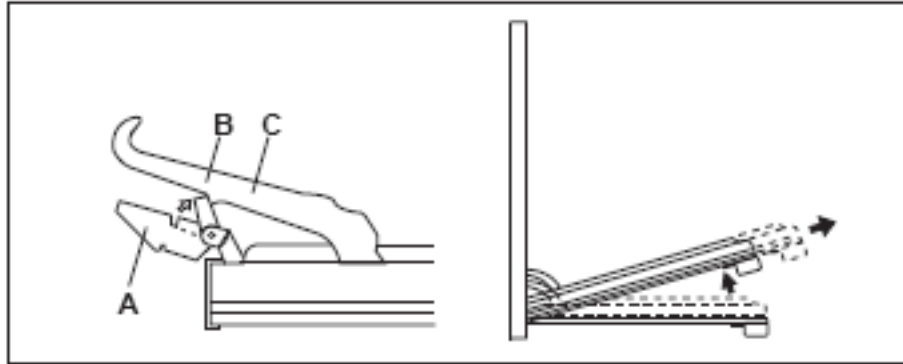

- Open the oven door fully.
- The hinges **(A)** are provided with two movable hooks **(B)**.
- Rotate the hooks into the slot **(C)**.
- You should grip the sides of the door at the centre and then incline it slightly towards the oven cavity and then by pulling it gently away from the oven cavity.
- **IMPORTANT:** You should make sure that the door is supported at all times and that you place the door on some padded material whilst cleaning it.
- The oven door and door glass should only be cleaned using a damp cloth and a small amount of detergent. The cloth **MUST NOT** have come into contact with any form of cleaning product or chemical previously.
- Replace the oven door by introducing the hinges back into their relevant slots. Before closing the doors **DO NOT FORGET TO RESET THE MOVABLE HOOKS.**
- **DO NOT** attempt to move the hooks whilst the door is not attached to the oven, as the hinges are under high spring tension and injury may result.

Removing the inner door glass for cleaning

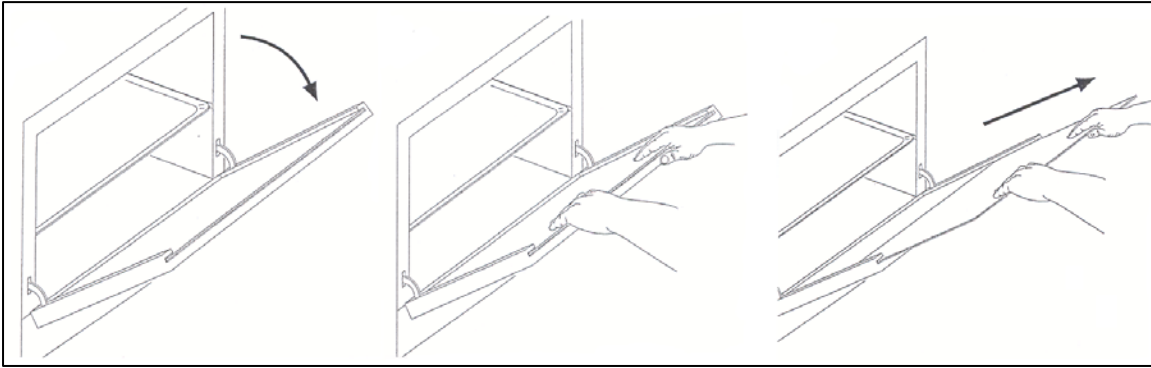

- To facilitate cleaning, the inner door glass can be lifted out of the oven door.
- Open the door halfway, you will see two screws on the top edge of the door. You should use a screwdriver to remove the screws and the strip that goes along the top of the oven door.
- Using both hands pull the inner door glass out of the oven door.
- **IMPORTANT: When the inner door glass is removed from the door, then the door springs will be under higher tension than normal. Therefore you should gently close the oven door, taking care not to trap your fingers.**
- The oven door glass should only be cleaned with warm soapy water, using either a sponge or soft cloth. These should not have come into contact with any other chemical previously. Do not use any abrasive cleaner that could cause damage to the glass.
- Remember that if the surface of the glass panel becomes scratched, this could lead to a dangerous failure.
- When refitting, make sure that the glass is correctly seated in the door recess and the correct way round. You should slide the door glass back into its original position.
- Using a screwdriver fully tighten the screws that attach the strip that you removed, to the top of the oven door.

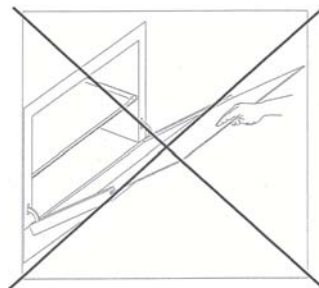

- **IMPORTANT:** Do not attempt to remove the door glass only using one hand.
- **IMPORTANT:** Care must be taken when cleaning between the door glasses, and inside the inner frame as some of the edges maybe sharp due to the manufacturing process.

Installation



The installation must be carried out by a suitably qualified person, in accordance with the current version of the following.

- **UK Regulations and Safety Standards or their European Norm Replacements.**
- **Building Regulations** (issued by the Department of the Environment).
- **Building Standards** (issued by the Scottish Development Department).
- **IEE Wiring Regulations.**
- **Electricity At Work Regulations.**
- **Gas Safety (Installation and Use) (Amendment) Regulations.**

Positioning



The adjacent furniture and all materials used in the installation must be able to withstand a minimum temperature of 85°C above the ambient temperature of the room it is located in, whilst in use.

- Your appliance is heavy, so you should be careful when moving or positioning it.
- **Do not** try to move the cooker by pulling on either the door, handle or control panel.

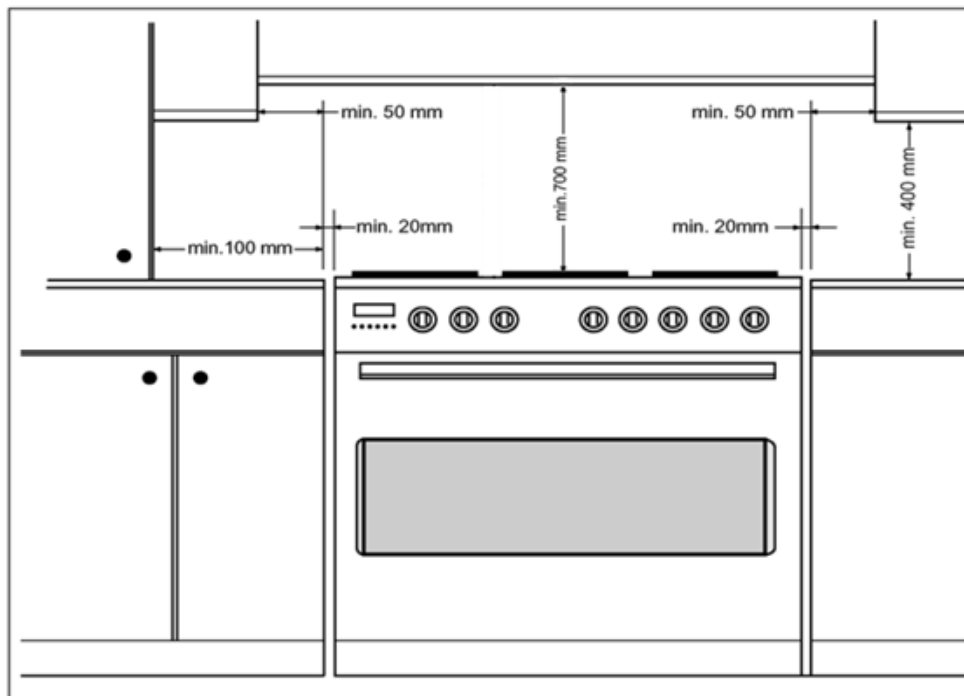

- The cooker is designed to slot in between 600 mm deep cabinets, which are spaced approximately 940 mm apart.
- It can also be used as freestanding, with a cabinet to one side, in a corner setting or with its back to a wall.
- **IMPORTANT:** It should not be installed at the end of a run of cabinets, if there is a cabinet at immediate right angles to the cooker door.
- The wall behind the cooker and 450 mm above and across the width of the cooker should be an incombustible material and preferably an easy clean surface, such as ceramic tiles.
- Any overhanging surface or cooker hood should be **at least 700 mm** above the highest point on the hob top (including the burners).
- Baumatic do not recommend that the cooker is positioned below wall cupboards, as the heat and steam from the appliance and what is being cooked, may damage the cupboard and its contents.
- The cooker may be located in a kitchen, or a bedroom, but not in a room containing a bath or shower. **The cooker must not be installed in a bedroom of less than 20m³ in size.**
- **LPG models** must not be installed in a room or internal space below ground level (e.g. in a basement).

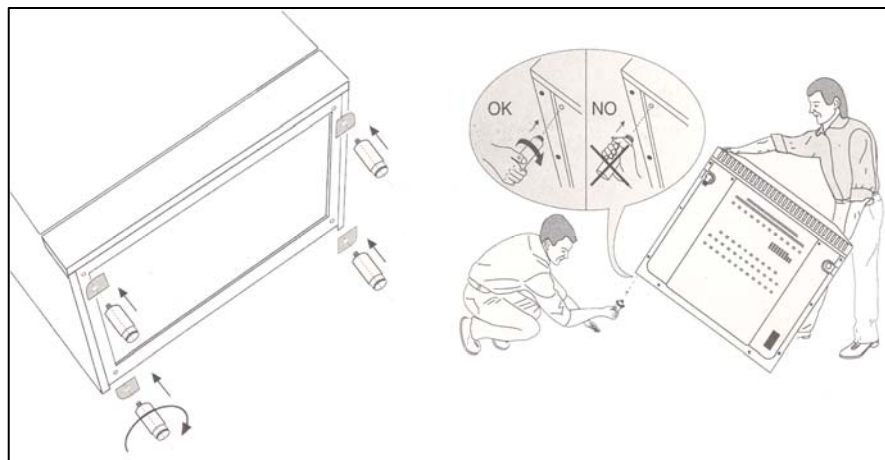

- The cooker is fitted with four legs that can be adjusted to match the height of your kitchen cabinets.
- To assemble them it is necessary to raise the cooker and to screw the four legs into position, on each corner of the base of the appliance.
- **IMPORTANT:** They must be screwed clockwise into position and not just slotted into the holes on each corner. You must screw them through the brackets that are also provided.

Gas connection



This appliance must be installed by a competent person in accordance with the current versions of the following UK (United Kingdom) or ROI (Republic of Ireland) Regulations and Safety Standards or their European Norm Replacements.

Important information

- This cooker is supplied to run on **natural gas only** and cannot be used on any other type of gas without modification.
- Conversion for use on LPG and other gases must only be undertaken by a qualified person. For information on the use of other gases, please contact the Baumatic Technical Department.
- The cooker must be installed by a qualified person, in accordance with the current edition of the Gas Safety (Installation and Use) (Amendment) Regulations and the relevant building/I.E.E. Regulations.
- Failure to install the appliance correctly could invalidate Baumatic's guarantee and lead to prosecution under the regulations quoted above.

- In the UK, **CORGI** registered installers are authorised to undertake the installation and service work, in compliance with the above regulations.

Ventilation requirements

- The room containing the cooker should have an air supply in accordance with the current edition of BS 5440: Part 2:
- The room must have opening windows or equivalent; some rooms may also require a permanent vent.
- If the room has a volume between 5 and 10m³, it will require an air vent of 50cm² (effective area). Unless it has a door which opens directly to the outside.
- If the room has a volume of less than 5m³, it will require an air vent of 100cm² (effective area).
- If there are any other fuel burning appliances in the same room the current edition of BS 5440: Part 2: should be consulted to determine air vent requirements.
- Ensure that the room containing the cooker is well ventilated, keep natural ventilation holes or install a mechanical ventilation device (mechanical cooker hood).
- Prolonged intensive use of the appliance may call for additional ventilation, either by the opening of a window, or by increasing the level of the mechanical ventilation device (where present).
- This cooker is not fitted with a device for discharging the products of combustion. Ensure that the ventilation rules and regulations are followed.
- Excess steam from the oven, vents out at the top back edge of the cooker, so make sure that the walls behind and near the cooker are resistant to heat, steam and condensation.
- Your cooker must stand on a flat surface so that when it is in position the hob is level. When in position check that the cooker is level by using a spirit level and adjust the 2 feet at the rear and the 2 feet at the front if necessary.
- Remember that the quantity of air necessary for combustion must never be less than 2m³/h for each kW of power (see total power in kW on the appliance rating plate).

Gas Safety (Installation and Use) Regulations

- It is the law that all gas appliances are installed by competent persons in accordance with the current edition of the **Gas Safety Installation and Use Regulations**.
- It is in your interest and that of safety to ensure compliance with the law.
- In the UK, CORGI registered installers work to safe standards of practice. The cooker must also be installed in accordance with the current edition of BS 6172. Failure to install the cooker correctly could invalidate the warranty, liability claims and lead to prosecution.
- **IMPORTANT: It is a requirement for a stability chain to be fitted to the appliance. Please see page 34 for more detailed information on this.**

Gas connection



ALL INSTALLATION AND SERVICE WORK MUST BE CARRIED OUT BY A CORGI REGISTERED ENGINEER.

- Prior to installation, ensure that the gas supply conditions (nature of the gas and gas pressure) and the adjustment conditions are compatible. The adjustment conditions for this appliance are stated on the rating plate which can be found on the back cover.
- This appliance is not designed to be connected to a combustion product evacuation device. Particular attention should be given to the relevant requirements regarding ventilation.
- Connection to the cooker should be made with an approved appliance flexible connection to BS 669.
- If the cooker has been converted for use with LPG, then it should be connected to the gas supply using a bayonet type hose. The hose **MUST** be suitable for use with LPG gas. They are identifiable by a red band or stripe.
- A hose length of 0.9m to 1.25m is recommended. The length of hose chosen should be such that when the cooker is in situ, the hose does not touch the floor.

- Care should be taken to ensure that the temperature rise of areas at the rear of the cooker that are likely to come in contact with the flexible hose do not exceed 70°C.
- Gas pressure may be checked on a semi-rapid hob burner. Remove the appropriate injector and attach a test nipple. Light the other burners and observe that the gas pressure complies with the gas standards in force.

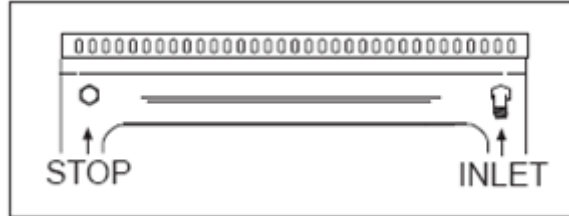

- This cooker can be connected to the supply both on the right and left hand side at the rear of the cooker. To reverse the position, remove the blanking plug and refit it to the opposite side to where the hose is being connected.
- **IMPORTANT: On completion carry out a gas tightness test.**

Gas adjustment (Conversion to LPG)



All work must be carried out by a CORGI registered engineer.

IMPORTANT: Always isolate the cooker from the electricity supply before changing the injectors and/or adjusting the minimum flow of the burners.

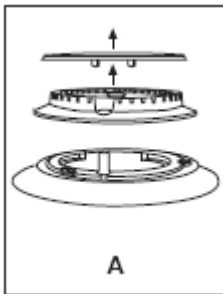

- Remove the pan-stands, burners and flame spreaders **(A)**.

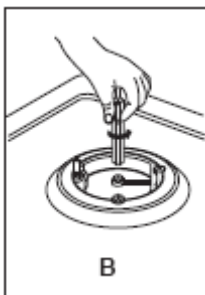

- Unscrew the injector **(B)** and replace it with the stipulated injector for the new gas supply (see table below).

| TECHNICAL DATA | | | | | | | |
|---------------------------|-------------|---------|--------------------|-----------------------------------|------------------------|--------------|--------------|
| BURNER TYPE (sizes mm) | GAS TYPE | | PRESSURE (mbar) | INJECTOR MARKING (1/100 mm) | GAS CON- SUMPTION* | POWER (kW) | |
| | | | | | | MAX. | MIN. |
| AUXILIARY Ø 55 | liquid gas | G30/G31 | 28..30/37 | 52 | 73 g/h | 1.000 | 0.300 |
| | natural gas | G20 | 20 | 72 X | 95 dm ³ /h | | |
| SEMIRAPID Ø 75 | liquid gas | G30/G31 | 28..30/37 | 68 | 127 g/h | 1.750 | 0.440 |
| | natural gas | G20 | 20 | 98 | 167 dm ³ /h | | |
| RAPID Ø 100 | liquid gas | G30/G31 | 28..30/37 | 88 | 218 g/h | 3.000 | 0.750 |
| | natural gas | G20 | 20 | 116 | 286 dm ³ /h | | |
| TRIPLE Ø 130 | liquid gas | G30/G31 | 28..30/37 | 96 | 262 g/h | 3.600 | 1.500 |
| | natural gas | G20 | 20 | 135 | 343 dm ³ /h | | |

- Reassemble all the burners carefully; in particular you should make sure that the flame spreader is correctly placed on the burner.

IMPORTANT: After changing the injectors YOU MUST follow the minimum flow adjustment section below.

Minimum flow adjustment for hob gas taps.



All work must be carried out by a CORGI registered engineer.

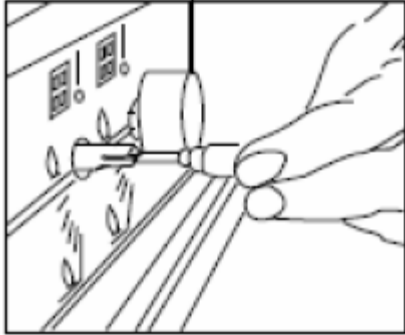

- Light the burner and set the knob at the minimum position.
- Remove the knob from the tap and place a small bladed screwdriver in the centre of the tap shaft.
- Unscrew the adjusting screw, in order to increase the gas flow or tighten the adjusting screw to decrease the gas flow.
- The correct adjustment is obtained when the flame has a length of about 3 – 4 mm.
- For butane/propane gas, the adjusting screw must be tightly screwed in.
- Refit the control knob.
- Make sure that the flame does not go out by quickly turning from maximum flow to minimum flow. If it does then remove the control knob and make further adjustments to the gas flow, testing it again once the adjustment has been made.
- **IMPORTANT: On completion carry out a gas tightness test.**

Fitting a stability chain



IMPORTANT: It is a legal requirement for your CORGI registered installer to fit a stability chain.

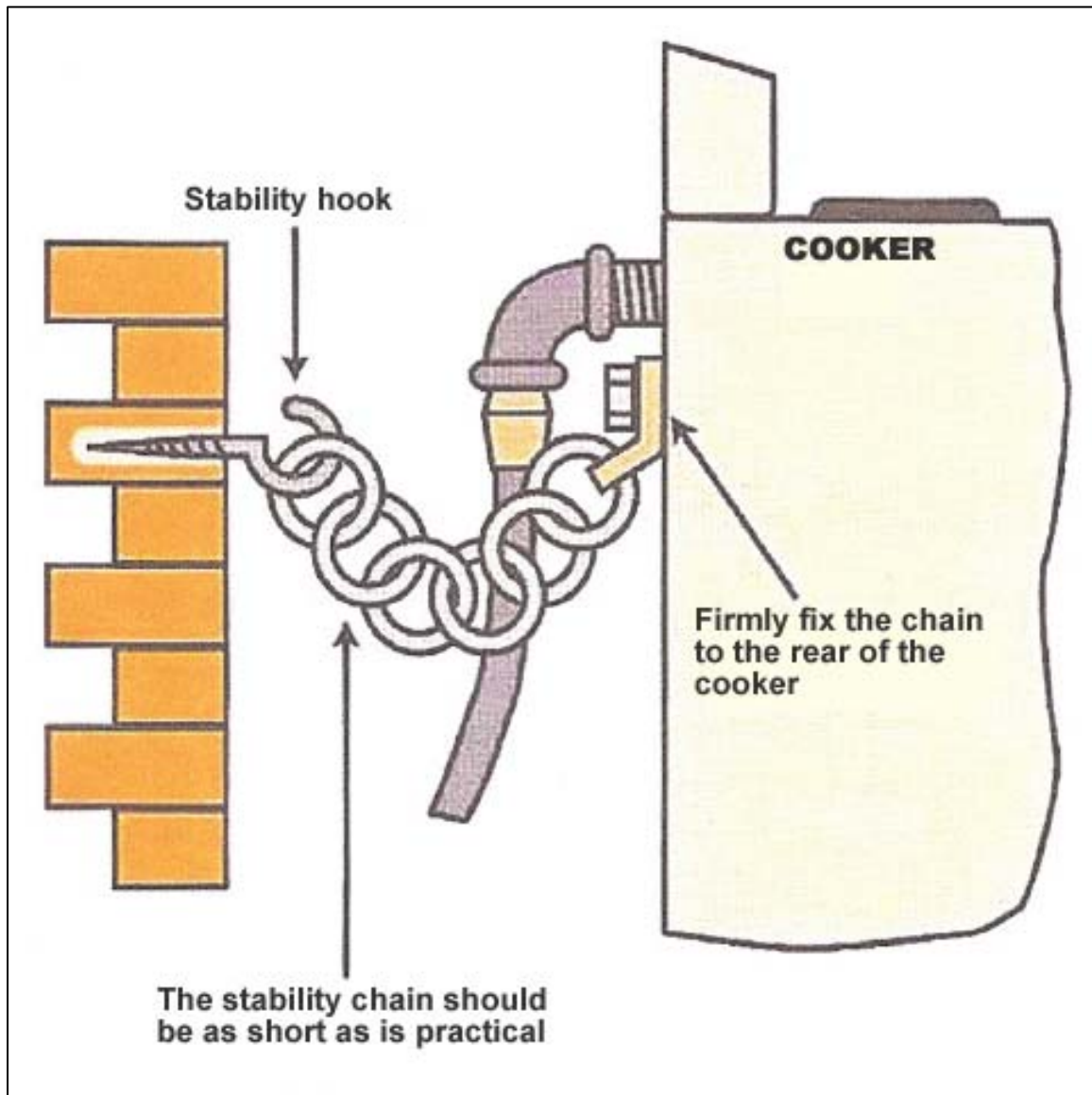

The stability hook should be securely fixed to the fabric of the building, in an adjacent position to the safety chain at the rear of the appliance.

The chain should be kept as short as is practical.

Electrical connection



This appliance must be installed by a qualified person in accordance with the latest edition of the I.E.E. Regulations and in compliance with Baumatic's instructions.

Before connecting the appliance, make sure that the supply voltage marked on the rating plate corresponds with your mains supply voltage.

WARNING: THIS APPLIANCE MUST BE EARTHED.

- This appliance must be wired into a 13 A double pole switched fused spur outlet, having 3 mm contact separation and placed in an easily accessible position adjacent to the appliance. It should not be located above the appliance and no more than 1.25m away from it.
- The spur outlet must still be accessible even when your oven is located in its operating position.
- Cable type: H05 RRF 3 core x 1.5 mm³

Connecting the mains supply cable

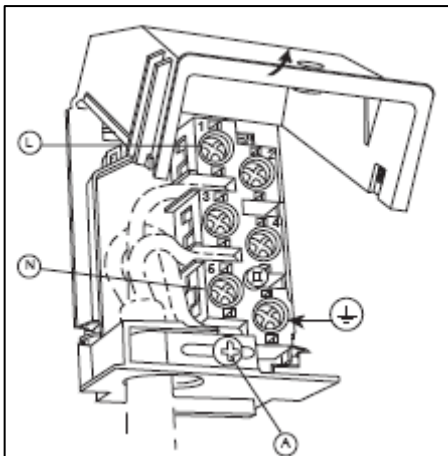

IMPORTANT

The wires in the mains lead are coloured in accordance with the following code:

**GREEN AND YELLOW
BLUE
BROWN**

**EARTH
NEUTRAL
LIVE**

- Open the mains terminal block cover as shown, unscrew the cable clamp (A) and unscrew (not fully) the screws in the mains terminal block (L, N, E) which secure the three wires of the mains cable.
- Fit the cable and refit the cable clamp (A).
- Allow sufficient cable length for the cooker to be pulled out for cleaning, but do not let it hang closer than 50mm to the floor.

- The cable can be looped if necessary, but make sure that is not kinked or trapped when the cooker is in position.

Replacing the mains supply cable

If the mains supply cable is damaged, then it must be replaced by an appropriate replacement.

The mains supply cable should be replaced in accordance with the following instructions:

- **Switch the appliance off at the control switch.**
- Open the box of the supply board.
- Unscrew the clamp (A) fixing the cable.
- Replace the cable with one of the same length and in accordance with the specification given above.
- The "green-yellow" earth wire must be connected to the terminal marked \perp . It must be about 10 mm longer than the live and neutral wires.
- The "blue" neutral wire must be connected to the terminal marked with letter (N) - the live wire must be connected to the terminal marked with letter (L).

My appliance isn't working correctly

- **The oven isn't coming on.**
 - * Check that the oven is in manual operation mode.
 - * Check that you have selected a cooking function and a cooking temperature.
- **There appears to be no power to the oven and grill.**
 - * Check that the appliance has been connected to the electrical mains supply correctly.
 - * Check that the mains fuses are in working order.
 - * Check that the operating instructions for setting the time of day and putting the appliance into manual operation mode have been followed.
- **The grill function works but the main oven does not.**
 - * Check that you have selected the correct cooking function.
- **The grill and top oven element is not working, or cuts out for long periods of time during use.**
 - * Allow the oven to cool for approximately 2 hours. Once cool, check whether the appliance is again working properly.
- **My food is not cooking properly**
 - * Ensure that you are selecting the correct temperature and the correct cooking function for the food that you are cooking. It may be appropriate to adjust your cooking temperature by plus or minus 10°C, to achieve the best cooking results.
- **My food is not cooking evenly**
 - * Check that the oven has been installed correctly and is level.
 - * Check that the correct temperatures and shelf positions are being used.

- **The oven light is not working**

- * Refer to page 23 and follow the "Replacing the oven bulb" section.

- **I am getting condensation in my oven**

- * Steam and condensation is a natural by product of cooking any food with high water content, such as frozen food, chicken etc.

- * You may get condensation in the oven cavity and forming between the oven door glasses. This is not necessarily a sign that the oven is not working correctly.

- * Do not leave food in the oven to cool after it has been cooked and the oven has been switched off.

- * Use a covered container, where practical, when cooking to reduce the amount of condensation that forms.



IMPORTANT: If your appliance appears not to be operating correctly, then you should disconnect it from your mains supply and then contact the Baumatic Service Department on telephone number (0118) 933 6911.

DO NOT ATTEMPT TO REPAIR THE APPLIANCE YOURSELF.

Please note that if an engineer is asked to attend whilst the product is under guarantee and finds that the problem is not the result of an appliance fault, then you may be liable for the cost of the call out charge.

The appliance must be accessible for the engineer to perform any necessary repair. If your appliance is installed in such a way that an engineer is concerned that damage will be caused to the appliance or your kitchen, then he will not complete a repair.

This includes situations where appliances have been tiled in, sealed in with sealant, have wooden obstructions placed in front of the appliance, like plinths. Or any installation other than the one specified by Baumatic Ltd. has been completed.

Please refer to the conditions of guarantee that appear on the warranty card that you receive with the appliance.



You will be mine ...

United Kingdom

Baumatic Ltd.,
Baumatic Buildings,
6 Bennet Road,
Reading, Berkshire
RG2 0QX
United Kingdom

Sales Telephone

(0118) 933 6900

Sales Fax

(0118) 931 0035

Service Telephone

(0118) 933 6911

Service Fax

(0118) 986 9124

Spares Telephone

(01235) 437244

Technical Advice Telephone

(0118) 933 6933

E-mail:

sales@baumatic.co.uk
technical@baumatic.co.uk

Website:

www.baumatic.co.uk

Republic of Ireland

01- 6266 798

Czech Republic

Baumatic CR spol s.r.o.
Amperova 495
46215, Librec
Czech Republic

+420 800 185 263

www.baumatic.cz

Slovak Republic

Baumatic Slovakia, s.r.o.
Skultetyho 1
831 04 Bratislava 3
Slovakia

+421 255 640 618

Germany

Baumatic Gmbh
Janderstrasse 9
Mannheim, 68199
Germany

+4962 112 9190

www.baumatic.de

Italy

Baumatic Italia S.R.L.
Via Caltana 129
Campodarsego (Padova), 35011
Italy

+3904 9920 2297

www.baumatic.it

Holland

Baumatic Benelux B.V.
Grindzuigerstraat 22
1333 MS ALMERE
The Netherlands

+3136 549 1555

www.baumatic.nl



www.baumatic.com