

USER MANUAL FOR YOUR BAUMATIC

RETRO14BL/RETRO14IV

**315 Litre retro style
fridge freezer**





Baumatic®

NOTE: This User Instruction Manual contains important information, including safety & installation points, which will enable you to get the most out of your appliance. Please keep it in a safe place so that it is easily available for future reference, for you or any person not familiar with the operation of the appliance.

DD 24/02/09

Contents

Contents	2
Environmental note	3
Important safety information	4-5
Use of the appliance.....	4
Before using your appliance.....	4
Refrigerant.....	4
Child safety.....	4
General safety.....	4
Service.....	5
Specifications of your RETRO14BL/RETRO14IV	5
Dimensions of appliance.....	5
Description of the appliance	6-8
Control panel.....	7
Description of the product features.....	7-8
Using your Baumatic fridge freezer	8-11
Before switching on.....	8
During first use.....	8
The LED display.....	8
Fridge/freezer section selector dial.....	9
Switching on the appliance.....	9
Switching off the fridge section only.....	10
Switching off the appliance.....	10
Setting the thermostat.....	10-11
Arranging and storing food in the fridge section	11
The  freezer section	11-14
Fast freeze function.....	12
Freezing fresh food.....	12-13
Tips on freezing.....	13
Storing commercially frozen food.....	13-14
Defrosting frozen food.....	14
Making ice cubes.....	14
Freezer alarm.....	14
Cleaning and maintenance	15-18
The defrost drain hole.....	15-16
Defrosting the  freezer section.....	16-17
Replacing the light bulb.....	17-18
Installation	18-19
Electrical connection.....	18
Positioning.....	19
Troubleshooting	20-21
Contact details	22

Environmental note

Note: Before discarding an old appliance, switch off and disconnect it from the power supply. Cut off and render any plug useless. Cut the cable off directly behind the appliance to prevent misuse. This should be undertaken by a competent person. Disable the door lock to make sure that children cannot get stuck inside the appliance.

This appliance is marked according to the European directive 2002/96/EC on Waste electrical and Electronic Equipment (WEEE). By ensuring this product is disposed of correctly, you will help prevent potential negative consequences for the environment and human health, which could otherwise be caused by inappropriate waste handling of this product.



The symbol  on the product, or on the documents accompanying the product, indicates that this appliance may not be treated as household waste. Instead it shall be handed over to the applicable collection point for the recycling of electrical and electronic equipment. Disposal must be carried out in accordance with local environmental regulations for waste disposal. For more detailed information about treatment, recovery and recycling of this product, please contact your local city office, your household waste disposal service or the shop where you purchased the product.



- The packaging materials that Baumatic uses are environmentally friendly and can be recycled.
- Please discard all packaging material with due regard for the environment.

Important safety information



Your safety is of the utmost importance to Baumatic. Please make sure that you read this instruction booklet before attempting to install or use the appliance. If you are unsure of any of the information contained in this booklet, please contact the Baumatic Advice Line.

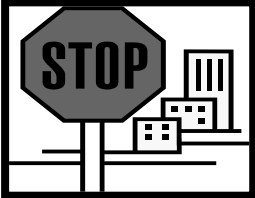

IMPORTANT: Any installation work must be carried out by a qualified electrician or competent person.

Use of the appliance

- Your appliance is only designed to be used in the home. It is suitable for storing food that needs to be chilled and refrigerated. If it is used for any other purpose or it is not used correctly, then Baumatic Ltd. will accept no liability for any damage that is caused.
- Altering the specification of the appliance must not be attempted for reasons of safety.



Before using your appliance

- Check the appliance for any signs of transport damage. If you notice any damage, then you should not connect your appliance to your mains supply and should contact your retailer.

Refrigerant

- Your appliance contains R600a refrigerant, which is a natural gas that does not contain CFCs that can damage the environment. However it is a flammable substance, therefore care should be taken:
 - During the transportation and installation of the appliance, make sure that the refrigeration pipework does not get damaged.
 - If it does become damaged then sources of ignition and open flames should be avoided. Also the room that the appliance is situated in should be thoroughly ventilated.
- Do not place any objects on top of the appliance, as this may damage the table top.



Child safety

- Packaging material should be kept away from children.
- Children should not be allowed to touch the controls or play with the appliance.



General safety

- Do not pull on the power supply cable to remove the plug from your mains supply socket.
- Do not pull out or insert the plug with wet hands.
- Do not attempt to use your appliance outdoors or any place where it is likely to come into contact with the elements.
- Before cleaning the appliance or performing maintenance work, ensure that the appliance has been disconnected from your mains supply.
- Never allow the back coils of the appliance to come into contact with the wall surface.



- Always ensure that the location where you are installing your appliance is free of stored items such as papers and other flammable materials.
- Never block the ventilation openings of the appliance, either on the inside or its exterior.
- It is vital to keep your appliance well ventilated, so that there is proper air flow between the bottom of the unit and the plinth/kick plate which it is sitting on.
- Do not place electrical devices inside of the appliance, such as mixers or ice cream makers.

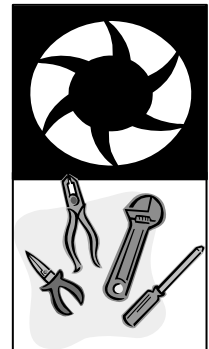

Service

You should not attempt to repair the appliance yourself, as this could cause injury or a more serious malfunction. If you require a service call then please contact the Customer Care Department.

Specifications of your RETRO14BL/RETRO14IV

Congratulations on purchasing a Baumatic fridge freezer

- Total gross/net capacity: 342/315 litres
- Gross capacity (fridge/freezer): 231/111 litres
- Energy efficiency: A+
- Star rating: ****

- Adjustable thermostat
- Automatic defrost (fridge section)
- LED display
- Anti-bacterial surface
- Fast freeze function
- 3 Adjustable glass shelves
- 2 Bottle shelves
- Egg rack
- 2 General racks
- Salad crisper
- Ice cube tray
- 3 Freezer drawers
- Adjustable feet

Dimensions of appliance

Height: 1887 mm
 Width: 600 mm
 Depth: 640 mm

* Please refer to the installation instructions for more specific information on the size of aperture that you will require.

IMPORTANT: When you install your appliance it is important to bear in mind its climatic rating.

In order to find out the climatic rating of your appliance, you should check the rating plate. The rating plate is located on the front left edge of the inside of the fridge section. You will need to open the door of your appliance to be able to find it. The rating plate will indicate the ambient temperature range that your appliance will function correctly within.

Description of the appliance

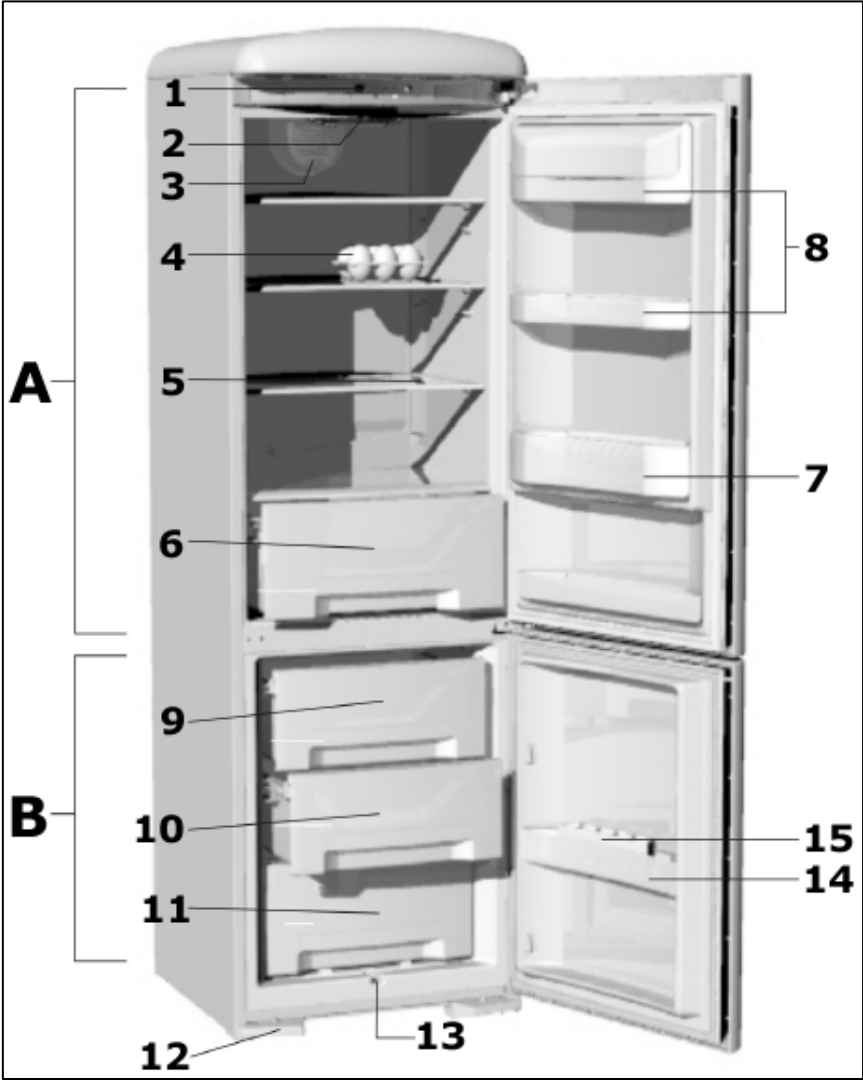

Fridge section (A)

- 1) Control panel
- 2) Interior light
- 3) Fan
- 4) Egg tray
- 5) Adjustable shelf (3 supplied)
- 6) Salad crisper
- 7) Bottle shelf (2 supplied)
- 8) Upper door shelves

Freezer section (B)

- 9) Fresh food freezing drawer
- 10) Frozen food storage drawer
- 11) Frozen food storage drawer
- 12) Adjustable feet
- 13) Defrost water groove
- 14) Freezer door shelf (2 supplied)
- 15) Ice cube tray

NOTE: The above diagram is for illustrative purposes only. Your appliance may differ in appearance and features.

Control panel

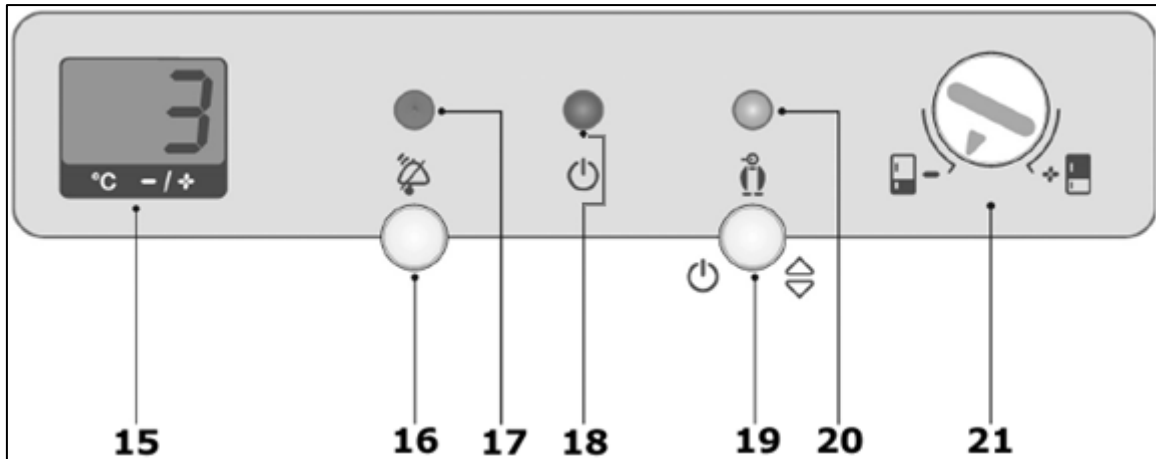

- 15) LED display
- 16) Warning alarm off button
- 17) Warning alarm neon
- 18) ON/OFF neon
- 19) ON/OFF button and temperature setting button
- 20) Fast freeze function neon
- 21) Fridge/freezer section selector dial

Description of the product features

1) Shelves

- The shelves may be placed in any of the guide slots within the interior of the appliance. They are protected from sliding out.
- To remove a shelf: Take off all of the items that are stored on the shelf that you want to remove. Then lift the front of the shelf and carefully pull it out of the grooves.

2) Defrost water outlet

- The interior of the refrigerator is cooled by the cooling plate that is on the rear wall. Beneath this there is a channel and an outlet for the defrost water.
- It is important that this channel never becomes clogged, see "The defrost drain hole" section for a detailed explanation of how to keep the channel clear.

3) Salad crisper drawer and cover

- The salad crisper drawer is in the bottom of your refrigerator and there is a cover that goes over it.
- The cover helps to prevent fruit and vegetables from drying out prematurely.

4) Upper door shelves

- The door liner holds various shelves, which are suitable for storing eggs, cheese, butter and yogurt. As well as smaller packages, tubes, cans etc.

5) Bottle shelves

- The bottle shelves should be used for storing reasonably sized bottles.

- **IMPORTANT: IT IS IMPORTANT THAT NONE OF THE SHELVES THAT SIT IN THE DOOR ARE OVERLOADED, AS THIS WILL DRASTICALLY REDUCE THEIR WORKING LIFE.**

6) Freezer section

- A  freezer section, with a gross capacity of 111 litres.

Using your Baumatic fridge freezer

Before switching on

- Make sure that it has been installed by a suitably qualified person, as per the information contained in Baumatic's installation instructions.
- After delivery, wait for eight hours before connecting the appliance to your mains supply. This will allow any refrigerant gasses that may have been disturbed during the transportation process to settle.
- The outside of the appliance and the removable accessories contained within it, should be cleaned with a solution of liquid detergent and water.
- The interior of the appliance should be cleaned with a solution of sodium bicarbonate dissolved in lukewarm water. The interior and accessories should be thoroughly dried, after the cleaning process has been completed.
- There can be an odour when you first switch on the appliance. It will lessen as the appliance starts to cool.

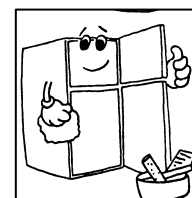

During first use

- You should set the temperature in each section to its lowest setting for 24 hours after switching on the appliance for the first time.
- When you first switch on the appliance, the compressor will run continuously for approximately 24 hours or until the fridge freezer reaches a cool enough temperature.
- During this period of time, you should try not to open the door frequently or place a large amount of food within the appliance.
- You should then adjust the temperature in each section to its normal operating temperature.
- If the unit is switched off or unplugged, you must allow at least 5 minutes before restarting the appliance on the thermostat or connecting it to your mains supply.

The LED display

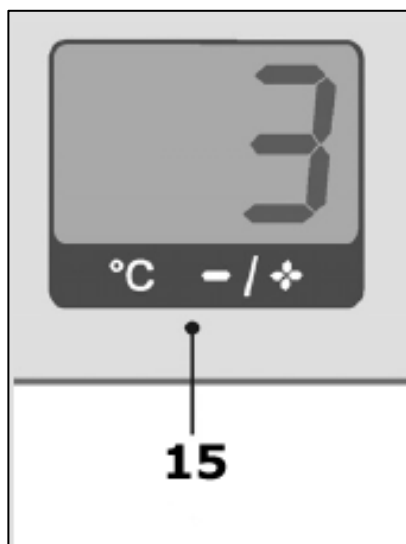

- The LED display **(15)** will show the temperature that is currently being maintained by either the fridge or freezer section.
- If the fridge freezer selector dial **(21)** is turned to the freezer symbol, then the temperature of the freezer will appear on the LED display **(15)**.
- If the fridge freezer selector dial **(21)** is turned to the fridge symbol, then the temperature of the freezer will appear on the LED display **(15)**.

Fridge/freezer section selector dial

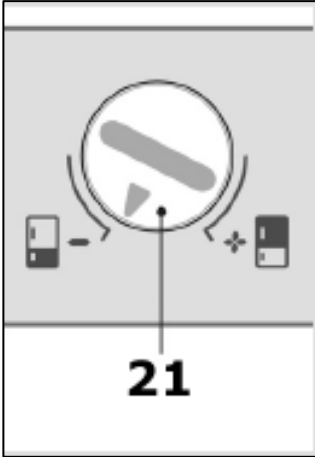

- The fridge/freezer section selector dial **(21)** should be used to select which section of the appliance you wish to control.

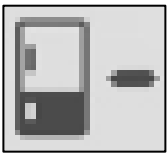

- If the selector dial is pointing at the symbol opposite, then the temperature of the freezer section can be adjusted.

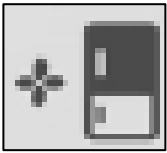

- If the selector dial is pointing at the symbol opposite, then the temperature of the fridge section can be adjusted.

- You may need to use a coin to allow you to turn the fridge/freezer section selector dial

Switching on the appliance

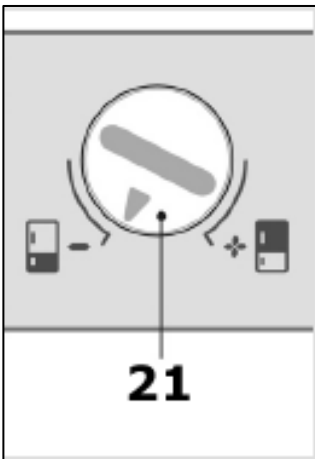

- Connect the appliance to your mains supply.
- Turn the fridge/freezer section selector dial **(21)** to the freezer symbol.

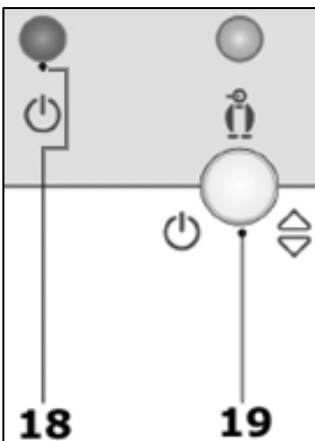

- Press and hold down the ON/OFF button **(19)** for 3 seconds.
- The ON/OFF neon **(18)** will light to confirm that you have switched on the appliance.

Switching off the fridge section only

- Turn the fridge/freezer section selector dial (21) to the fridge symbol.
- Press and hold down the ON/OFF button (19) for 3 seconds and the fridge section will go off, but the freezer section will continue to operate.
- To switch the fridge section back on, make sure that the fridge/freezer section selector dial (21) is pointing the fridge symbol and then press and hold down the ON/OFF button (19) for 3 seconds.

Switching off the appliance

- Turn the fridge/freezer section selector dial (21) to the freezer symbol.
- Press and hold down the ON/OFF button (19) for 3 seconds.
- The ON/OFF neon (18) will go out to confirm that you have switched the appliance off.

Setting the thermostat

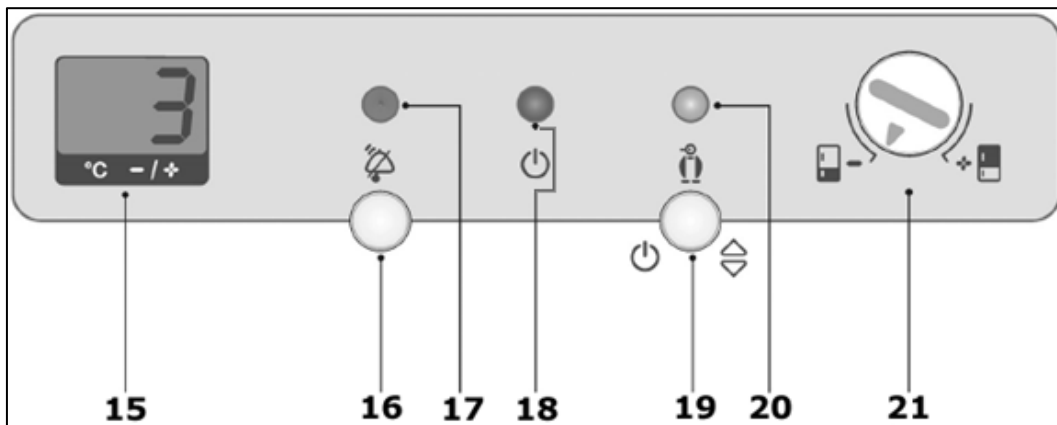

- It is necessary to set individual temperatures for the fridge and freezer sections.
- Turn the fridge/freezer section selector dial (21) to either the fridge or freezer symbol.
- Press the temperature setting button (19) and the available temperature settings will appear on the LED display (15). Whilst you are setting the temperature, the LED display (15) will flash.
- If you go past the temperature that you require, continue to press the temperature setting button (19) until the temperature appears on the LED display (15) again.

- **IMPORTANT:** The freezer section should not be set to run above -18°C.

- **IMPORTANT:** The fridge section should not be set to run above 5°C.

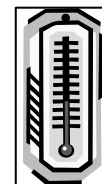

- When the temperature that you require appears on the LED display (15), you should stop pushing the temperature setting button (19).
- After approximately 5 seconds, the LED display (15) will stop flashing and the temperature setting will be saved.
- The LED display (15) will then return to showing the temperature that is currently being achieved.
- The fridge section can cool down to just above 0°C.
- The freezer section can cool down to -18°C and lower.
- **IMPORTANT:** The ambient temperature of the room, the temperature of food and the amount of food that has been placed in the fridge freezer and how often the door is opened, will all affect the temperature being maintained by the appliance.

- On colder temperature settings, your fridge freezer will work harder to maintain a lower temperature. There is no need to run your appliance on maximum setting for either the fridge or freezer sections for prolonged periods.
- We would recommend that you set the fridge section to a temperature of 3 - 4°C and the freezer section to a temperature of -18°C.
- **IMPORTANT:** If the fridge section is set to a lower temperature than 5°C for prolonged periods of time, the defrost drain hole may freeze.

Arranging and storing food in the fridge section

- Warm food or evaporating liquids should not be stored in your refrigerator, as this will increase the humidity inside of the appliance.
- All foods should be wrapped or covered, this is particularly important if the food has a strong flavour. You should use polythene bags or sheets, aluminium foil, wax paper. Liquids should be stored in covered containers or bottles.
- To maximise the space inside of the fridge section, any excessive packaging on the food should be removed.
- Quickly perishable food should be stored at the back of the refrigerator, which is the coldest part of the appliance.
- No food items should be allowed to come into contact with the back wall of the refrigerator.
- Make sure that you arrange food in such a way that the door can close completely. Particular attention should be given to bottles that may protrude when placed on shelves inside the main section of the refrigerator.
- Some organic solutions, such as the oils in lemon/orange peel and acid in butter, can cause damage to the plastic parts contained inside of the refrigerator.
- Do not open the refrigerator door too often or leave the door open for long periods of time, as this will increase the temperature inside of the appliance.
- **Meat** should be wrapped in polythene bags and then placed on the glass shelf above the salad crisper.
(Meat should only be stored in this manner for one or two days at the most).
- **Cold dishes/cooked food** should be covered and can be placed on any shelf.
- **Fruit and vegetables** should be cleaned thoroughly and placed in the salad drawer.
- **Cheese and butter** should be placed in airtight containers, or they can be wrapped in aluminium foil or polythene bags. As much air as possible should be removed from the bags.
- **Milk bottles** should have a cap on them and be stored on the bottle shelf that sits in the door.
- Garlic, potatoes, onions and bananas should only be stored in a refrigerator IF they are kept in airtight containers.

The freezer section

The freezer section is suitable for storing and freezing food.

- The freezer compartment temperature must have already reached -18 degrees centigrade (or lower) before you attempt to store food that is already frozen or freezing fresh food.
- The freezer compartment is only able to freeze a certain quantity of food at one time. You should not attempt to freeze more than 10 kilograms of fresh food within a 24 hour period.
- Warm food should be allowed to cool down before you attempt to freeze it. If you place warm food in the freezer compartment, then the increased humidity will cause quicker ice formation and increase the amount of power that the appliance uses.
- The guidance of the food manufacturer should be followed, in regard to the maximum storage time.

- Thawed foods must not be frozen for a second time.

Fast freeze function

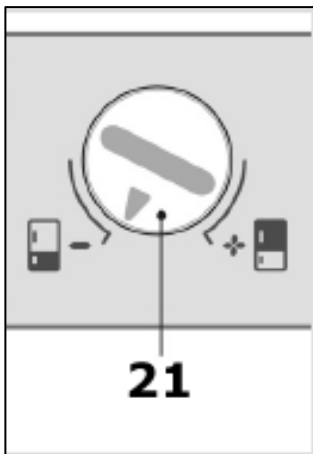

- Your appliance is fitted with a fast freeze setting, which you should use when freezing fresh food.
- Turn the fridge/freezer section selector dial **(21)** to the freezer symbol.

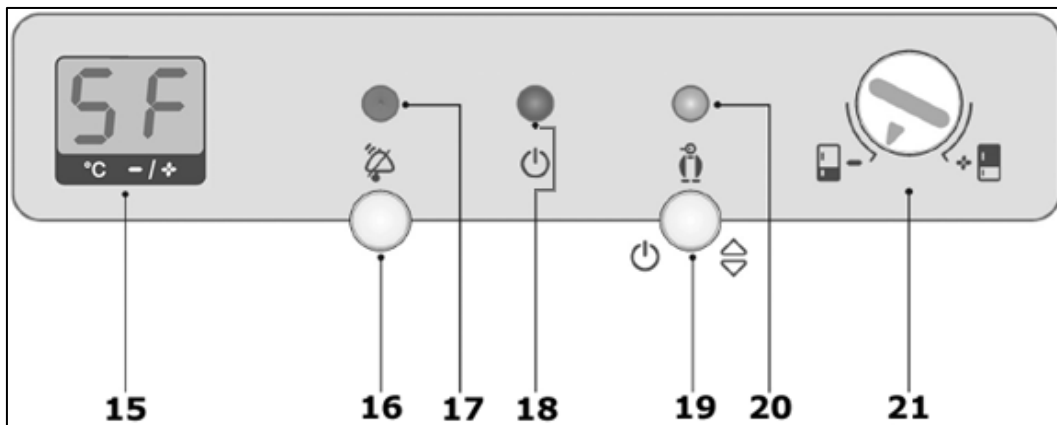

- Press the temperature setting button **(19)** until SF appears on the LED display. Whilst you are setting the temperature, the LED display **(15)** will flash.
- When SF appears on the LED display **(15)**, you should stop pushing the temperature setting button **(19)**.
- After approximately 5 seconds, the LED display **(15)** will stop flashing and the fast freeze function will be active.
- The fast freeze function neon **(20)** will light to confirm that the fast freeze function is active.
- To turn off the fast freeze function, turn the fridge/freezer section selector dial **(21)** to the freezer symbol.
- Press the temperature setting button **(19)** until your usual freezer section temperature appears on the LED display **(15)**.
- If the fast freeze function is not switched off, then it will do so automatically after approximately 2 days.
- IMPORTANT: The fast freeze function should not be switched on for prolonged periods of time; otherwise it may cause the appliance to overwork. It could also cause the fridge and freezer section to freeze over.

Freezing fresh food

- To freeze the maximum amount of fresh food specified on page 11, you should switch on the fast freeze function.
- For more detailed information on the fast freeze function, see the previous section. This should be done at least 3 hours prior to attempting freezing.



- When freezing smaller amounts of fresh food or storing items that are already frozen, there is no need to adjust the position of the thermostat dial or switch on the fast freeze function.



- Fresh food should be frozen in the fresh food freezing drawer (9).



- Fresh food should be packed into airtight containers or packaging. This will help to make sure that the food doesn't dry out or lose its flavour. It will also ensure that flavour does not transfer from other foods.

- Do not allow fresh food to touch items that are already frozen.

- After 24 hours you should check that the fresh food is satisfactorily frozen. If it is then the fast freeze function should be switched off. Food can then be transferred from the fresh food freezing drawer (9) to one of the frozen food storage drawers (10) or (11).

- **IMPORTANT: The fast freeze function should not be switched on for prolonged periods of time; otherwise it may cause the appliance to overwork. It could also cause the fridge and freezer section to freeze over.**

Tips on freezing

- Freezer bags, polythene wraps, aluminium foil (extra thick) and special cans for frozen foods are suitable packaging for storing frozen goods in.
- Tape, rubber bands or plastic clips are suitable for sealing bags and wrappings.
- Before sealing a suitable bag, you should compress the air out of it, as this will help the food to freeze more easily.
- Flat packages freeze more easily.

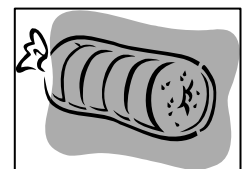

- If you are freezing liquid, then do not fill the container to the brim. Liquids will expand when being frozen.
- **Do not place bottles (glass or tin) containing liquids (especially sparkling liquids) into the freezer as they could cause the bottle to burst during freezing.**

Storing commercially frozen food

- The storage time and recommended temperature for storing commercially frozen foods are indicated on the packaging.
- Always follow the manufacturer's instructions for storage and use of frozen food.
- When shopping, be careful to choose food which is adequately packed and is provided with complete storage instructions. It should have been stored in a freezer where the temperature does not rise above -18°C.
- Do not buy packages of food that are covered with frost. This could indicate that the package has thawed at least once before.

- Take care that your frozen food packages do not start to thaw before you place them in your freezer. This will shorten the length of time that you can safely store the food for.

Defrosting frozen food

- Partially thawed or defrosted foods should be used as soon as possible.
- Cold air preserves the food but it does not destroy the micro organisms which rapidly activate themselves after defrosting and make foods perishable.
- Partial defrosting reduces the nutritional value of food, especially fruits, vegetables and readymade meals.

Making ice cubes



- Remove the cap from the ice cube tray **(15)** and fill it to the indicating mark with cold water or some other liquid, suitable for freezing.
-

- Close it and place it in the freezer door shelf **(14)**. The ice tray can produce 8 cubes.
- The period required for ice to form is 2-6 hours. It is recommended to make a quantity of ice, prior to the time that you require it.
- Ice cubes are discharged from the tray by turning the tray upside down and placing it under cold running water.
- Shake the tray, open the cover and pour the ice out.

Freezer alarm

- If the appliance senses an excessive rise in temperature in the freezer section, the warning alarm neon **(17)** will flash and an audible signal will sound.
- If the warning alarm neon lights and the audible signal sounds, then you should check that the temperature for the freezer section is set to an appropriate level (i.e. at least -18°C).
- If the temperature for the freezer section **IS** set appropriately, then you should contact the Baumatic Service Department.
- The audible alarm can be cancelled by pressing the warning alarm off button **(16)**.
- The alarm will sound every 24 hours, if the temperature in the freezer is still not low enough to safely store food.
- The light goes off automatically when the freezer cools to a temperature where there is no longer a danger to the food being stored in the appliance.
- When the appliance is first switched on, there is an inbuilt 24 hour delay to the freezer alarm switching on. This will prevent the alarm triggering unnecessarily whilst the appliance is getting down to working temperature.

Cleaning and maintenance

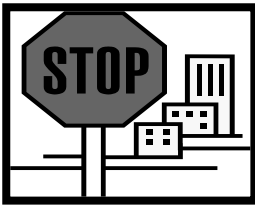

WARNING: PLEASE ENSURE THAT YOUR APPLIANCE IS DISCONNECTED FROM YOUR MAINS SUPPLY BEFORE ATTEMPTING TO CLEAN IT.

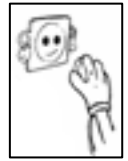

- Do not clean the appliance by pouring water onto it or spraying water over it.



- The refrigerator and freezer compartment should be cleaned periodically, using a solution of bicarbonate of soda and lukewarm water.

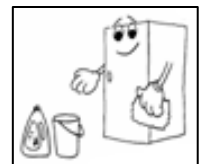

- Clean the accessories separately with soap and water. Do not clean them in a dishwasher.



- Do not use abrasive products, detergents or soaps.



- After washing the appliance, wipe over the area that you have cleaned with a damp cloth and then dry it thoroughly.

- When cleaning is complete, dry your hands and then reconnect the plug to your mains supply.

The defrost drain hole

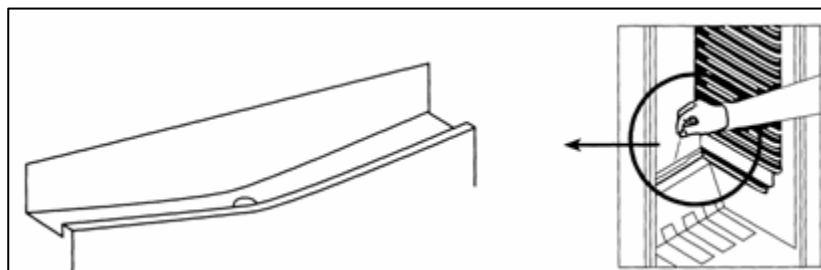

- Defrosting occurs automatically in the refrigerator compartment during operation. The defrost water is collected by the evaporating tray and evaporates automatically.
- The drain hole should be cleaned periodically with the drain hole cleaner. This will prevent water from collecting in the bottom of the refrigerator, instead of flowing down the defrost drainage channel and drain hole.
- **IMPORTANT:** Please note that the drain hole cleaner should not be left in position permanently. Otherwise this may prevent the defrost water from entering the drain hole.
- You can also pour a small amount of water down the drain hole to clean the defrost drainage channel.

- You should be careful to make sure that food packages do not touch the rear wall of the appliance, as this can interrupt the automatic defrosting process and deflect water into the base of your refrigerator.
- Use a solution of bicarbonate of soda and lukewarm water to clean the evaporating tray.
- **IMPORTANT:** It is normal to get some ice droplets forming on the back wall of the appliance. The formation of ice droplets does not indicate an appliance fault.
- If you are getting a lot of ice on the back wall of the appliance, then check that the thermostat is set appropriately and that the fast freeze function has not been switched on.

Defrosting the freezer section

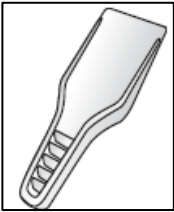

The frost in the freezer compartment should be removed periodically. You can use a plastic scraper to keep down the amount of frost that builds.

- You should defrost the freezer compartment, when the frost layer in the freezer reaches a thickness of around 3 – 5 mm.
- 24 hours prior to defrosting, you should switch on the fast freeze function (as described on pages 12). This will continuously freeze the food inside the freezer, helping to preserve it during the defrost process.
- Whilst defrosting the appliance, the food should be removed from the freezer section and wrapped in several layers of paper and stored in a cool place. The foods rise in temperature will shorten its storage life and therefore the food should be used within a relatively short period of time.
- **DO NOT PLACE FOOD BACK IN THE FREEZER SECTION THAT HAS STARTED TO THAW.**
- Turn the fridge/freezer section selector dial **(21)** to the freezer symbol.

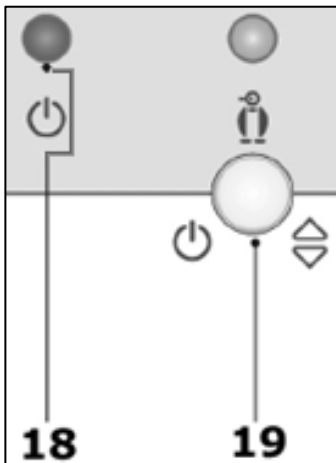

- Press and hold down the ON/OFF button **(19)** for 3 seconds.

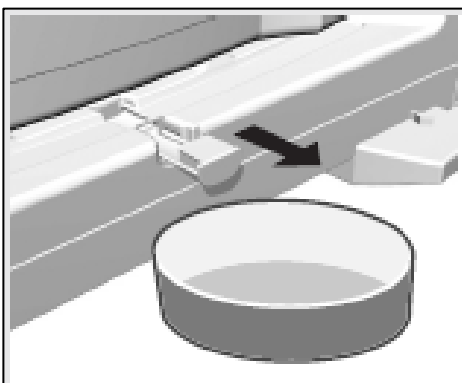

- To drain the defrost water; you should pull the funnel shaped groove at the bottom of the appliance out. Then place a convenient vessel underneath the groove to collect the defrost water.

- **IMPORTANT:** You should place some old towels on the flooring that is immediately in front of the appliance. In case any defrost water comes out of the freezer section and onto the floor.
- Avoid using any defrosting sprays, as they may cause damage to plastic parts and may be hazardous to your health.
- Once all the ice that has built up has melted, then the inside of the freezer section should be dried thoroughly. Failure to do this will result in immediate ice build when the appliance is turned back on.
- Make sure that the fridge/freezer section selector dial **(21)** is still pointing to the freezer symbol.
- Switch the freezer section back on by holding down the ON/OFF button **(19)** for 3 seconds. The ON/OFF neon **(18)** will light to confirm that you have switched the appliance back on again.
- You should run the fast freeze function for 24 hours after the appliance has been switched back on.
- You should not attempt to freeze fresh food inside the freezer section until this 24 hour time period has elapsed.
- **IMPORTANT:** The fast freeze function should not be switched on for prolonged periods of time; otherwise it may cause the appliance to overwork.
- **Do not defrost the appliance with other electrical devices (e.g. hair dryer). Do not use sharp metal objects to remove the ice on the freezer, as this could cause damage to the refrigerant system.**

Replacing the light bulb

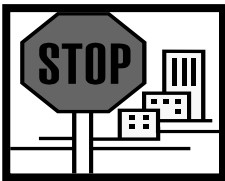

WARNING: PLEASE ENSURE THAT YOUR APPLIANCE IS DISCONNECTED FROM YOUR MAINS SUPPLY BEFORE ATTEMPTING TO REPLACE THE LIGHT BULB.

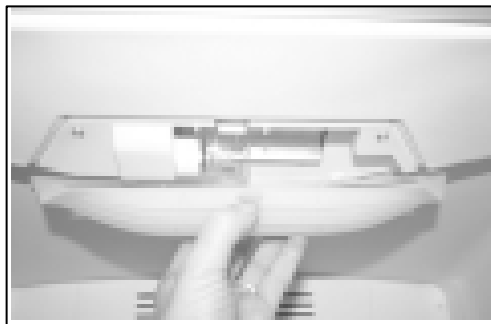
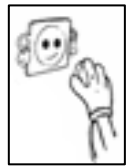

- The interior light is located on the roof of the fridge section.
- Press down the plastic section that clips into the front of the light bulb cover and then gently ease the cover away from the roof of the fridge section.
- The bulb that you should use is an E14 max, which is the same as the bulb originally fitted by the factory.
- Please dispose of the bulb correctly.
- The light bulb is not covered by Baumatic's guarantee.
- Replace the light cover and after waiting five minutes, reconnect your plug to your mains supply.
- Turn the fridge/freezer section selector dial **(21)** to the freezer symbol.

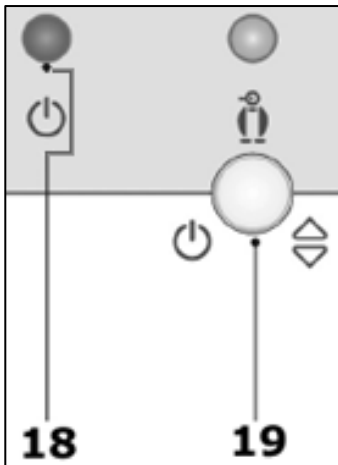

- Press and hold down the ON/OFF button **(19)** for 3 seconds.
- The ON/OFF neon **(18)** will light to confirm that you have switched the appliance back on again.

Installation

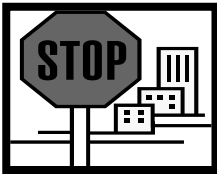

IMPORTANT: Before installation and usage read all the instructions and make sure that the voltage (V) and the frequency (Hz) indicated on the rating plate are exactly the same as the voltage and frequency in your home. The rating plate can be found on the front left edge of the inside of the refrigerator.

The manufacturer declines all responsibility in the event of the installer failing to observe all the accident prevention regulations in force, which are necessary for normal use and the regular operation of the electric system.

Electrical connection



YOUR FRIDGE FREEZER IS INTENDED FOR FITTED AND PERMANENT INSTALLATION.

We recommend that the appliance is connected by a qualified electrician, who is a member of the N.I.C.E.I.C. and who will comply with the I.E.E. and local regulations.

- Your refrigerator comes supplied with a 13 amp plug fitted. If in future you need to change the fuse in this plug, then a 13 amp ASTA approved (BS 1362) fuse must be used.

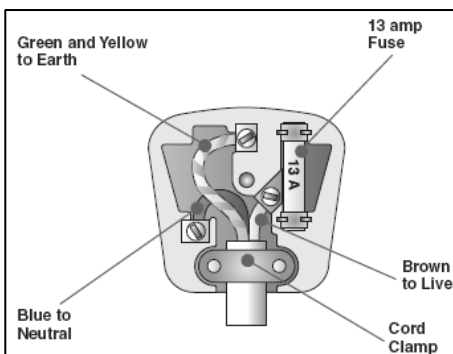

The wiring in the mains lead is coloured as follows:

Brown- Live
Blue- Neutral
Green and yellow- Earth

- As the colours of the wires in the appliance's mains lead may not correspond with the coloured markings identifying the terminals in your spur box, please proceed as follows:

The **brown wire** must be connected to the terminal marked "L" (live), or coloured **red**.

The **blue wire** must be connected to the terminal marked "N" (neutral), or coloured **black**.

The **green and yellow wire** must be connected to the terminal marked "E" (earth), or by the earth symbol, or coloured **green and yellow**.

- When the connection is completed, no stray strands or cut wire should be present. The cord clamp must be secured over the outer sheath.

Positioning

- It is advisable that your appliance is only installed in a location where the ambient temperature of the room, corresponds with the climate classification that is stated on the rating plate of your appliance. Your appliance may not function correctly if the ambient temperature falls outside of the following ranges.

Climate classification	Appropriate ambient temperature
SN	+10 to +32 degrees centigrade
N	+16 to +32 degrees centigrade
ST	+16 to +38 degrees centigrade
T	+16 to +43 degrees centigrade

- Positioning the appliance requires two people in order to avoid injuries or damage to the appliance.
- Your appliance should not be located in direct sunlight or exposed to continuous heat or extremes of temperature (e.g. next to a radiator or boiler). If this is not feasible, then you should install an insulation plate between the appliance and the adjacent heat source.
- You should check whether there is an electrical socket available, which will be accessible after your appliance is installed.

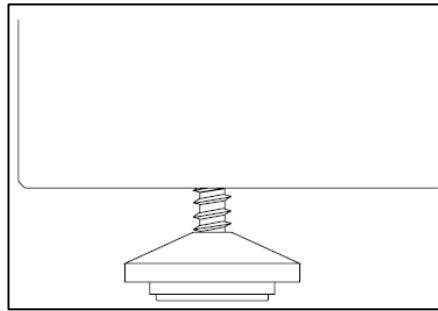

- Place the appliance flatly and firmly on a solid base. The appliance is fitted with adjustable feet at the front, which should be used to level off the appliance.
- Anything positioned above the appliance must be at least 15 cm away to allow sufficient cooling of the condenser. You must allow a 5 cm gap to the rear and either side of the appliance.

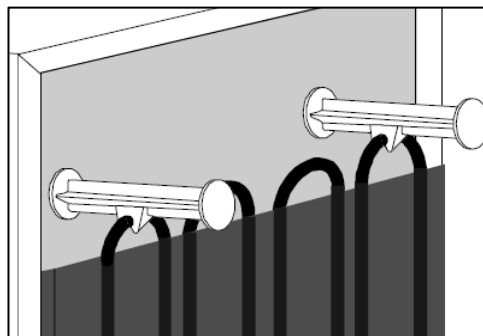

- If supplied, you should fit two spacers to the back of the cabinet, at the top of the condenser. This will ensure that the correct distance is maintained at the rear of the appliance.
- If you are placing another cooling appliance next door to this product, then there must be a gap of at least 2cm between the appliances. This will help to prevent condensation from forming.
- Be sure to leave enough space for the opening of the door, to avoid damage to the appliance or personal injury.

Troubleshooting



IMPORTANT: If your fridge freezer appears not to be operating properly, before contacting the Baumatic Service Department, please refer to the checklist below.



My fridge freezer does not appear to be working/there is no power to my appliance.

- Check that the plug is fully inserted into the power socket.
- Check that there is power to your mains supply (e.g. that there hasn't been a power cut or that the fuse hasn't blown).
- Check that the thermostat has not been turned to the off position.
- Check that your mains supply voltage, corresponds to the voltage stated on the rating plate of your appliance.



My fridge freezer appears to be performing poorly

- Check that the appliance isn't overloaded and that food hasn't been packed too tightly into it.
- The thermostat setting is too low; you should turn the thermostat up higher.
- Ensure that the door is closing properly and that the door has not been opened for a prolonged period in error.
- Ensure that there is adequate ventilation for your appliance.



My fridge freezer is noisy

- The refrigerant gas that circulates the pipework of the appliance may make a slight noise, even if the compressor is not running.
- If the noise worsens or the appliance gets louder than normal; check that it is levelled off correctly, that nothing is touching the rear of the fridge freezer and that nothing placed inside the appliance is rattling.



Ice has formed on the inner back wall of my fridge

- Check that food has not been pushed too far back inside the appliance, so that it is in contact with the inner back wall.
- **IMPORTANT:** It is normal to get some ice droplets forming on the back wall of the appliance. The formation of ice droplets does not indicate an appliance fault.
- If you are getting a lot of ice on the back wall of the appliance, then check that the thermostat is set appropriately and that the fast freeze function has not been left switched on.



There is water in the base of the fridge or leaking out of my fridge.

- Follow the "The defrost drain hole" section on page 15 - 16.



IMPORTANT: If your appliance appears not to be operating correctly, then you should disconnect it from your mains supply and then contact the Customer Care Department on telephone number (0118) 933 6911.

DO NOT ATTEMPT TO REPAIR THE APPLIANCE YOURSELF.

Please note that if an engineer is asked to attend whilst the product is under guarantee and finds that the problem is not the result of an appliance fault, then you may be liable for the cost of the call out charge.

The appliance must be accessible for the engineer to perform any necessary repair. If your appliance is installed in such a way that an engineer is concerned that damage will be caused to the appliance or your kitchen, then he will not complete a repair.

This includes situations where appliances have been tiled in, sealed in with sealant, have wooden obstructions placed in front of the appliance, like plinths. Or any installation other than the one specified by Baumatic Ltd. has been completed.

Please refer to the conditions of guarantee that appear on the warranty card that you receive with the appliance when it is delivered.

**United Kingdom**

Baumatic Ltd.,
Baumatic Buildings,
6 Bennet Road,
Reading, Berkshire
RG2 0QX
United Kingdom

Sales Telephone

(0118) 933 6900

Sales Fax

(0118) 931 0035

Customer Care Telephone

(0118) 933 6911

Customer Care Fax

(0118) 986 9124

Spares Telephone

(01235) 437244

Advice Line Telephone

(0118) 933 6933

E-mail:

sales@baumatic.co.uk
customercare@baumatic.co.uk
spares@baumatic.co.uk
technical@baumatic.co.uk

Website:

www.baumatic.co.uk

Republic of Ireland

01- 6266 798

Czech Republic

Baumatic CR spol s.r.o.
Amperova 495
46215, Librec
Czech Republic

+420 800 185 263

www.baumatic.cz

Slovak Republic

Baumatic Slovakia, s.r.o.
Skultetyho 1
831 04 Bratislava 3
Slovakia

+421 255 640 618

Germany

Baumatic Gmbh
Janderstrasse 9
Mannheim, 68199
Germany

+4962 112 9190

www.baumatic.de

Italy

Baumatic Italia S.R.L.
Via Caltana 129
Campodarsego (Padova), 35011
Italy

+3904 9920 2297

www.baumatic.it

Holland

Baumatic Benelux B.V.
Grindzuigerstraat 22
1333 MS ALMERE
The Netherlands

+3136 549 1555

www.baumatic.nl

