

**BMC460BGL 44 Litre High
compact combination
microwave oven**

INSTRUCTION MANUAL

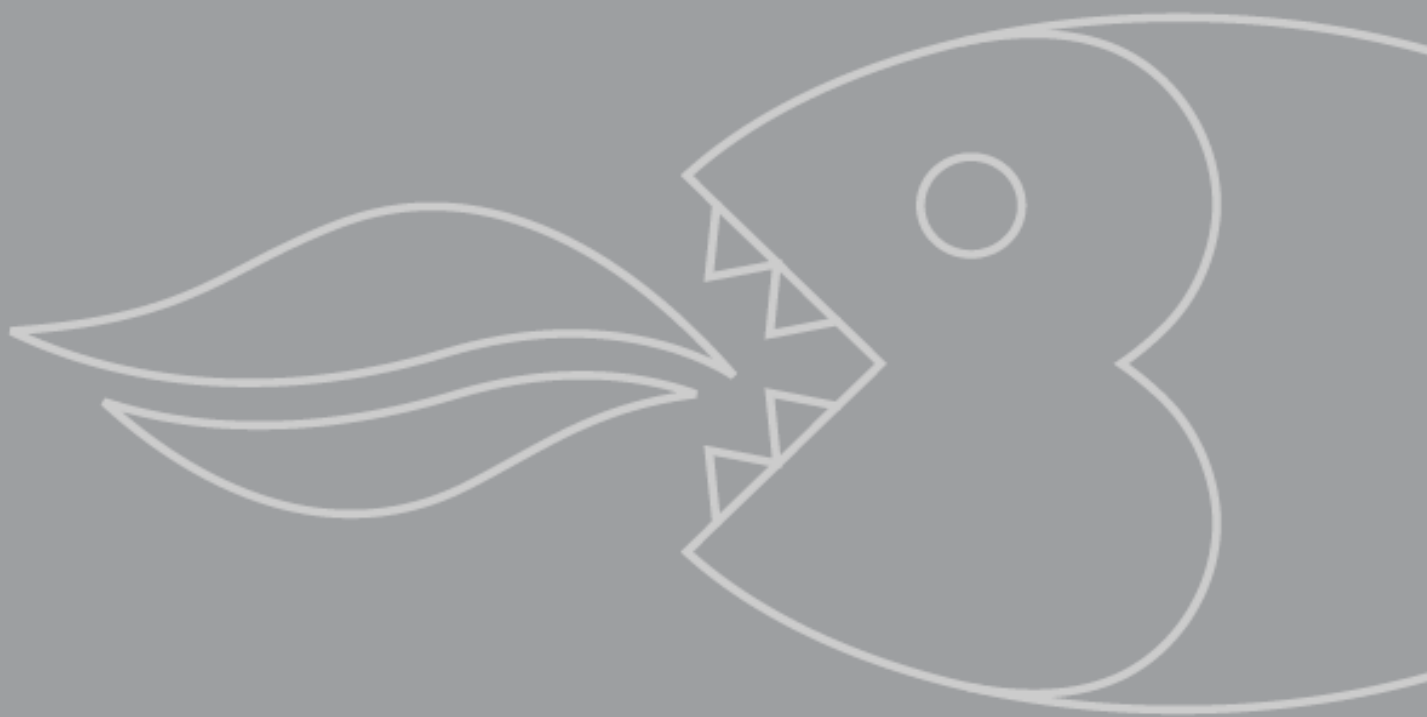

User Manual for your Baumatic

BMC460BGL

44 Litre High compact combination microwave oven



NOTE: This User Instruction Manual contains important information, including safety & installation points, which will enable you to get the most out of your appliance. Please keep it in a safe place so that it is easily available for future reference; for you or any person not familiar with the operation of the appliance.

Contents

Environmental note	4
Important safety information	5 – 9
Specifications	10 – 12
Product and aperture dimensions	10
Product specifications	10
Electrical details	10
Oven parts and accessories	11
Turntable installation	12
Control panel	12
Using your microwave	13 – 19
Microwave functions	13
Setting the clock	14
Before first use	14
Microwave cooking	14 - 15
Microwave power level chart	15
Time setting chart	15
Power level cooking chart	16
Grill cooking	16 - 17
Convection cooking	17 - 18
Grill fan cooking	18
Bottom-heat fan cooking	18
Combination cooking	20 - 29
Microwave and grill cooking	20
Microwave and convection cooking	21
Microwave and grill fan cooking	22
Microwave and bottom-heat cooking	23
Auto-menu cooking	24
Defrost function	25
Auto program table	24
Preheating function	26
Safety lock	26
Microwave cooking guidelines	26 – 27
Materials you can use in a microwave oven	28
Materials not to be placed in a microwave oven	29
Utensils table	29
Cleaning and maintenance	30 - 31
The appliance exterior	30
The appliance interior	30
Turntable and turntable support	30
General cleaning advice	30 - 31
Installation	31 - 34
Electrical connection	31 - 32
Aperture and ventilation requirements	33
Fixing the appliance into the housing unit	34
Troubleshooting	35 - 36
Contact details	37

Environmental note

This appliance is marked according to the European directive 2002/96/EC on Waste electrical and Electronic Equipment (WEEE). By ensuring this product is disposed of correctly, you will help prevent potential negative consequences for the environment and human health, which could otherwise be caused by inappropriate waste handling of this product.

The symbol  on the product, or on the documents accompanying the product, indicates that this appliance may not be treated as household waste. Instead it shall be handed over to the applicable collection point for the recycling of electrical and electronic equipment.

Disposal must be carried out in accordance with local environmental regulations for waste disposal.

For more detailed information about treatment, recovery and recycling of this product, please contact your local city office, your household waste disposal service or the shop where you purchased the product.



- The packaging materials that Baumatic uses are environmentally friendly and can be recycled.
- Please discard all packaging material with due regard for the environment.

IMPORTANT SAFETY INFORMATION



Your safety is of the utmost importance to Baumatic. Please make sure that you read this instruction booklet **before** attempting to install or use the appliance. If you are unsure of any of the information contained in this booklet, please contact the Baumatic Advice Line.

General Information

- This appliance is designed for domestic household use. It can **NOT** be used as a freestanding microwave and must be built in to a standard kitchen cabinet or housing unit (see the section entitled "Installation").
- You should only operate the appliance when the turntable and turntable support are in position.
- You should only use ovenware that is suitable for being used in a microwave.
- To prevent corrosion occurring due to moisture/condensation, the cavity and the door of the microwave should be wiped dry after each use of the appliance.
- The appliance must not be left unattended if you are heating or cooking food in containers that are made of paper, plastic or other flammable materials. If left unattended, they could pose a **fire hazard**.
- If you notice smoke coming from the appliance, you should keep the door of the microwave closed and then disconnect it from your mains supply. **DO NOT** use your microwave oven, if you think it is not operating correctly.

Installation

- **IMPORTANT:** *Only the built in/built under installation sanctioned by Baumatic and outlined in this manual should be followed.*
- **Do not** attempt to use your appliance outdoors or any place where it is likely to come into contact with the elements.

- **IMPORTANT:** *The adjacent furniture or housing and all materials used in the installation **must** be able to withstand a minimum temperature of 85°C above the ambient temperature of the room it is located in, whilst in use.*
- *Do not attempt to use your appliance outdoors or any place where it is likely to come into contact with the elements.*
- Certain types of vinyl or laminate kitchen furniture are particularly prone to heat damage or discolouration at temperatures below the guidelines given above.
- Any damage caused by the appliance being installed in contravention of this temperature limit, or by placing adjacent cabinet materials closer than 4mm to the appliance, **will be the liability of the owner.**
- For use in **leisure accommodation vehicles**, please refer to the appropriate information given in the installation instructions for this appliance.
- The use of this appliance for any other purpose or in any other environment without the express agreement of Baumatic Ltd. will invalidate any warranty or liability claim.
- Your new appliance is guaranteed against electrical or mechanical defects, subject to certain exclusions that are noted in Baumatic's Conditions Of Guarantee. The foregoing does not affect your statutory rights.

Service

- Your microwave complies with all relevant safety standards. In order for it to continue to operate safely, **only an engineer that is approved by the Baumatic Customer Care Department should work on the appliance.**
- **IMPORTANT:** *It is dangerous for a non qualified person to work on the appliance, in particular if they remove the cover that provides protection against exposure to microwave energy.*
- If you notice that the door seal, door surfaces, power cord and plug are damaged. You should stop using the appliance, disconnect it from the mains supply and contact the Baumatic Customer Care Department.
- Only genuine Baumatic spare parts should be fitted to your appliance. These can be obtained from the Baumatic Spares Department.

Warning and safety instructions

- This appliance complies with all current European safety legislation. Baumatic do wish to emphasise that this compliance does not remove the fact that the appliance surfaces **will become hot during use and retain heat after operation.**
- **DO NOT** place anything between the door and the door frame.
- **DO NOT** store anything that is flammable inside of the microwave. When it is switched on, the items could catch fire.
- **DO NOT** switch the appliance on if there is no food or liquid inside of the microwave. If you run the microwave whilst it is empty, there is a chance that it will overload.
- The door seals and the door surfaces should ALWAYS be kept clean and free from debris.

Child Safety

- Baumatic strongly recommend that babies and young children are prevented from being near to the appliance and not allowed to touch the appliance **at any time.**
- If it is necessary for younger family members to be in the kitchen, please ensure that they are kept under close supervision at all times.
- **IMPORTANT:** *This appliance should only be operated by adults. You SHOULD NOT allow young children to use the microwave without supervision. Older children should only operate the appliance if they have been thoroughly instructed on how to use the microwave and the consequences of improper usage.*

General Safety

- **Do not** allow electrical fittings or cables to come into contact with areas on the appliance that get hot.
- **Do not** use the appliance to heat the room it is located in.
- **Do not** use the appliance to dry paper, textiles or animals.
- **Do not** install the appliance next to curtains or soft furnishings.
- **Do not** use the appliance to heat unopened bottles or cans etc.

- **Do not** use corrosive chemicals or vapours in this appliance. This oven is especially designed to heat. It is not designed for industrial or laboratory use.
- **Do not** heat cooking oil or liquid containing alcohol, as there is the chance of spontaneous combustion.
- **Do not** boil eggs or similar foods in their shells, otherwise they may burst. It is possible to poach eggs in your microwave, providing you prick the yolks first.
- **Do not** attempt to lift or move cooking appliances by using the oven door, as this may cause damage to the appliance or result in injury to the person lifting the appliance.

Cleaning

- Cleaning of the oven should be carried out on a regular basis.
- Great care should be taken whilst using this appliance and when following the cleaning procedure.
- **IMPORTANT:** *The appliance must be disconnected from the mains before following the cleaning procedure.*

Installation



This appliance must be correctly installed by a suitably qualified person, strictly in accordance with the manufacturer's instructions.

- ***Baumatic Ltd. declines any responsibility for injury or damage, to person or property, as a result of improper use or installation of this appliance.***
- Heat, steam and moisture will be created during use of the appliance, take care to avoid injury and ensure that the room is adequately ventilated. If the appliance is going to be used for prolonged periods of time, then additional ventilation may be required.
- Please consult with your qualified installer if you are in any doubt about the amount of ventilation that you will require.

Declaration of conformity

- **CE:** Appliance conforming to the European directives 89/336/EEC, 93/68/EEC, 73/23/EEC and subsequent revisions and "RoHS" directive 2002/95/CE.*
- The manufacturer declares that the oven is built using certified materials and requires the appliance to be installed in accordance with the standards currently in force. This appliance must be used by a trained person for domestic purposes only.
- * The RoHS directive stands for "the restriction of the use of certain hazardous substances in electrical and electronic equipment". This directive bans the placing on the EU market of new electrical and electronic equipment containing more than the agreed levels of lead, cadmium, mercury, hexavalent chromium, polybrominated biphenyl (PBB) and polybrominated diphenyl ether (PBDE) flame retardants.

Specifications

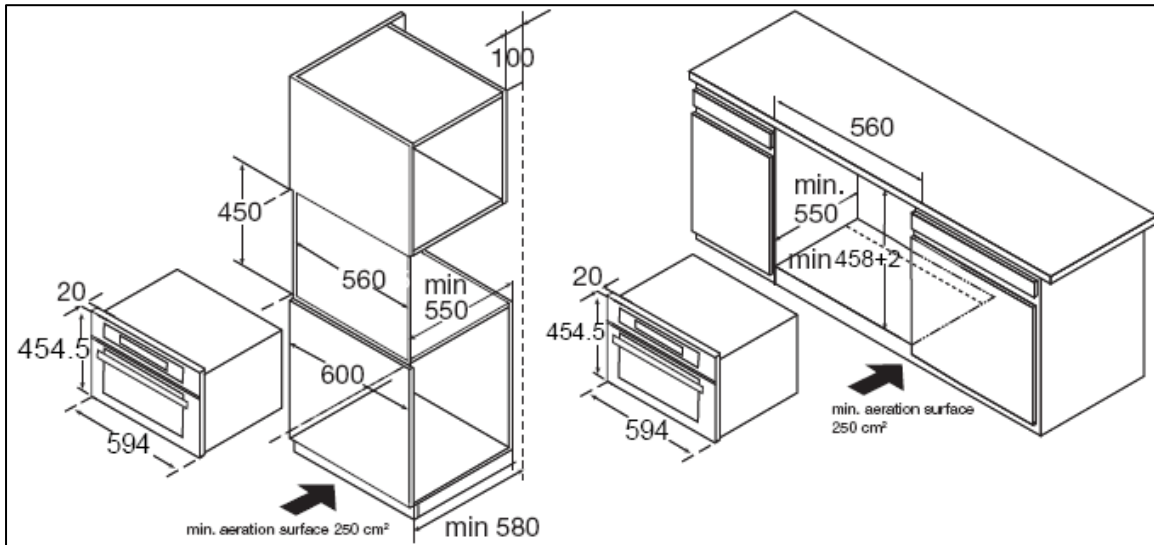

Product dimensions

Height: 454.5 mm
Width: 594 mm
Depth: 568 mm

Aperture dimensions

Height: 450 mm (built in)
458+2 mm MIN
(built under)
Width: 560 mm
Depth: 550 mm MIN

Product specifications

- **9 cooking functions**
- **15 auto functions**
- 5 power levels
- Quick start function
- LED full programmer
- Knob and touch control operation
- Safety lock
- Capacity: 44 litres
- Microwave output: 900 W
- Grill output: 1750 W
- Hot air output: 1750 W

Electrical details

Rated Voltage: 230 Vac 50 Hz
Fuse Rating: 16 AMP
Electrical Connection Rating: 3.35 kW

For future reference please record the following information which can be found on the rating plate and the date of purchase which can be found on your sales invoice. The rating plate for your oven can be located by opening the microwave oven door and looking on the right hand side of the chassis.

Model Number

Serial Number

Date of Purchase

Oven parts and accessories

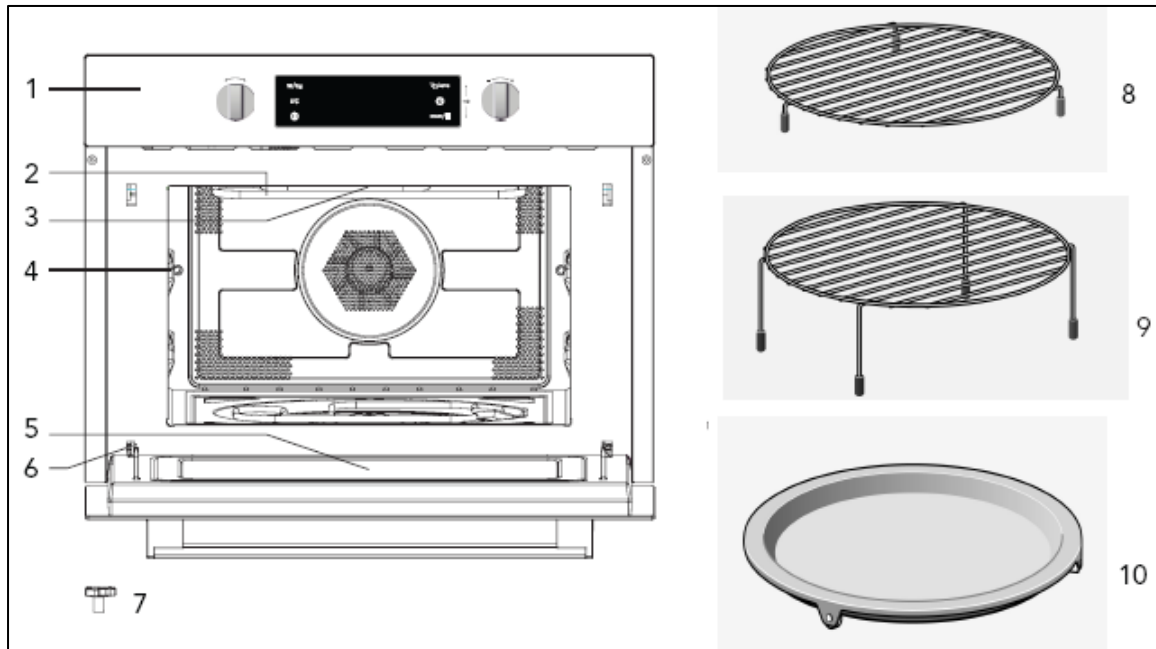

- 1)** Control panel
- 2)** Grill element
- 3)** Oven light
- 4)** Oven shelf level
- 5)** Door glass

- 6)** Hinge
- 7)** Turntable shaft
- 8)** Short grill rack
- 9)** Long grill rack
- 10)** Grill pan

Turntable installation

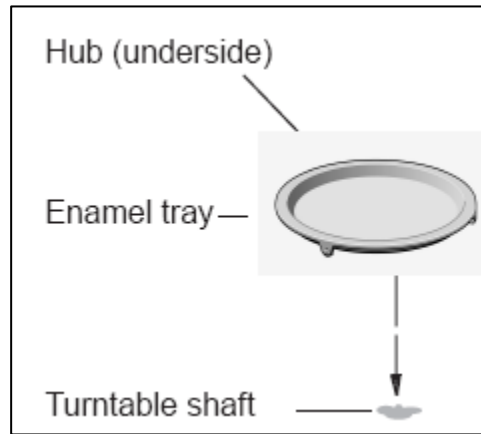

- **NEVER** place the enamel tray upside down. The enamel tray movement should never be restricted.
- The tray must **ALWAYS** be used during cooking.
- All food and containers of food should **ALWAYS** be placed on the enamel tray when cooking.
- If the tray cracks or breaks **DO NOT USE IT** and contact the Spares department to order a new one.

Control Panel

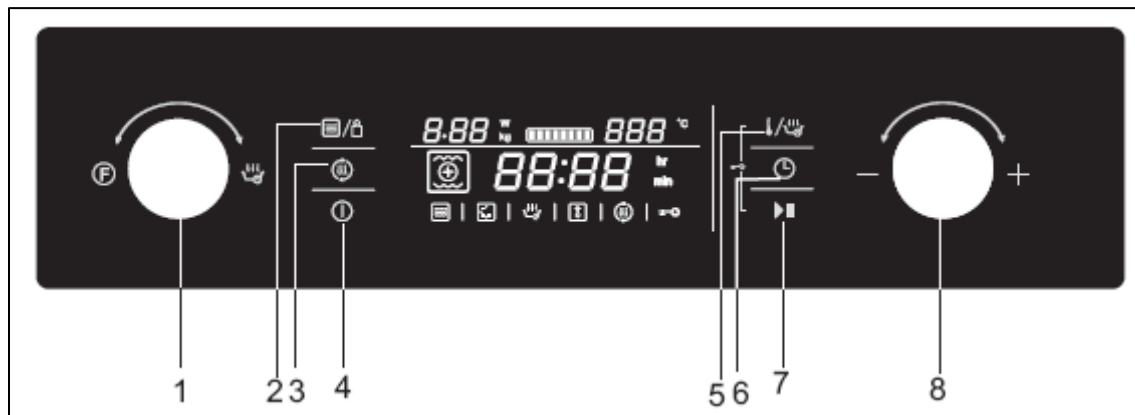















- 1) Cooking function selection dial
- 2) Microwave power / weight setting button
- 3) Pre-heating function button
- 4) ON / OFF button
- 5) Temperature setting / Auto menu setting button
- 6) Timer button
- 7) Start / stop button
- 8) Adjustment dial

Using your microwave

WARNING: The accessible surface may be hot during operation and for a period of time afterwards.

Functions:

Function		Mode		
	Microwave		Microwave	Use the microwave function to cook and reheat vegetables, potatoes, rice, fish and meat.
	Heating		Convection	With convection cooking you can prepare meals in the same way as you do with a conventional oven. The microwave is not activated. You are advised to preheat the oven before placing food into the oven.
			Grill with fan	Use this function to roast meals evenly and at the same time give the meal a brown crust.
			Grill	The grill is highly suitable to cook thin pieces of meat and fish
			Convection and bottom heat	Use this function to roast big pieces of meat and pizza.
	Combination		Convection	Use this function to roast food quickly.
			Grill with fan	Use these functions to cook meals quickly and at the same time give the food a brown crust (also au gratin). The microwave and the grill are activated at the same time. The microwave is cooking and the grill is roasting.
			Grill	
			Convection and bottom heat	Use this function to roast big pieces of meat and pizza.
	Auto-programs		P01 – P13	Automatic cooking programs.
	Defrost		d01 + d02	Defrost function

Setting the clock

- When your appliance is connected to the power supply for the first time, the LED display will show 0.00 and an audible signal will sound once.
- Use the adjustment dial **(8)** to adjust the current time. You can adjust the hour time between 00:00 – 23:59.
- When the display shows the correct time, release all buttons and in a few seconds the time will be set.

IMPORTANT: If the clock is not set, the oven will not function when powered.

Before first use

- To remove any residue from the oven that may have been left from the manufacturing process, you should place a cup that is half filled with water in the microwave.
- Set the microwave on its highest power level for 2 minutes.
- The oven cavity and outside of the appliance should be cleaned with warm soapy water, using either a sponge or soft cloth. No abrasive cleaners should be used. The appliance should be thoroughly dried afterwards.

Microwave cooking



- Once the clock has been set, your microwave is then ready to use.
- Check that the turntable and wire rack are correctly assembled in the cavity.
- Place whatever you are cooking in the centre of the microwave cavity and then close the microwave door. ***IMPORTANT: You should make sure that the door of the microwave is shut securely.***
- Press the ON / OFF button **(4)** once and the LED display will show the default mode of 900W and a time of 01:00.
- Turn the adjustment dial **(8)** to set the cooking time. The maximum time is 90 minutes or 30 minutes for full 900W power.

- Once the cooking time that you require appears on the LED display, press the microwave power button **(2)** to change the power setting.
- Turn the adjustment dial **(8)** to set the cooking power that you require. You can select from the power levels shown in the table below:

Power	100%	80%	50%	30%	20%
Display	900W	700W	450W	300W	100W

- To set a cooking time longer than 30 minutes on a lower power setting, first press the microwave power button **(2)** and use the adjustment dial **(8)** to choose a lower power level. You can then press the timer button **(6)** and use the adjustment dial **(8)** to set any length of time up to 90 minutes.
- Press the start / stop button **(7)** and your microwave will start to heat.
- At the end of the cooking time, your microwave will give an audible signal and the LED display will return to showing the time of day.
- ***IMPORTANT: The inside of the microwave and the food that you have been cooking may be extremely hot. So care should be taken when removing items from the microwave. We would recommend that you use an oven glove.***
- After the food has been removed from the microwave, you should make sure that the door is closed.

Time setting chart

When you are setting a cooking time, the clock will count in the following time intervals.

<i>Time period being set</i>	<i>Time intervals</i>
0 – 1 minute	1 seconds
1 – 5 minutes	10 seconds
5 – 15 minutes	30 seconds
15 – 60 minutes	1 minute
60 – 90 minutes	5 minutes

Power level cooking chart

Power level	Food
900 W	<ul style="list-style-type: none">○ Boiling water○ Reheating○ Cooking chicken, fish and vegetables
700 W	<ul style="list-style-type: none">○ Reheating○ Cooking mushrooms and shellfish○ Cooking dishes containing eggs and cheese
450 W	<ul style="list-style-type: none">○ Cooking rice and soup
300 W	<ul style="list-style-type: none">○ Defrosting○ Melting chocolate and butter
100 W	<ul style="list-style-type: none">○ Defrosting sensitive / delicate foods○ Defrosting irregularly-shaped foods○ Softening ice-cream○ Allowing dough to rise

This table should be regarded as only a guide. The power level requirement can vary depending on factors such as food weight, size and quality.

Grill cooking

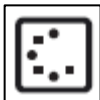

- Turn the cooking function selection dial **(1)** once clockwise to select cooking mode.



- Turn the adjustment dial **(8)** to select the grill cooking function. The MAX power level will be set as a default.

- ***IMPORTANT: You must select the cooking function within 10 seconds or the displayed default setting will be programmed.***
- Press the temperature setting button **(5)** to set the power level. Use the adjustment dial **(8)** to select the power level you require. There are 3 power levels with 3 as the MAX and 1 as the MIN.
- Press the timer button **(6)** to change the cooking time. The default time set is 10 minutes. Use the adjustment dial **(8)** to select the required cooking time. The maximum cooking time is 90 minutes.
- Press the start / stop button **(7)** and your microwave will start to grill.
- ***IMPORTANT: If the cavity temperature is higher than 160 degrees in the first 10 minutes, the oven will automatically change to a lower power level.***

- **IMPORTANT: The inside of the microwave and the food that you have been cooking may be extremely hot. So care should be taken when removing items from the microwave. We would recommend that you use an oven glove.**
- After the food has been removed from the microwave, you should make sure that the door is closed.

Convection cooking

- Convection cooking allows you to operate your microwave like a traditional oven. The appliance does not use microwaves to cook the food and **the cavity should be preheated before food is placed inside of it.**
- Place whatever you are cooking in the centre of the microwave cavity and then close the microwave door. **IMPORTANT: You should make sure that the door of the microwave is shut securely.**



- Turn the cooking function selection dial **(1)** once clockwise to choose cooking mode.



- Turn the adjustment dial **(8)** to select the convection function. The default temperature set is 180°C.
- **IMPORTANT: You must select the cooking function within 10 seconds or the displayed default setting will be programmed.**
- Press the temperature setting button **(5)** to alter the temperature. Use the adjustment dial **(8)** to select a temperature from 50 – 230°C. The maximum temperature is 230°C and the minimum temperature is 50°C.
- Press the timer button **(6)** to change the cooking time. The default time set is 10 minutes. Use the adjustment dial **(8)** to set the required cooking time. The maximum time is 5 hours.
- Press the start / stop button **(7)** and your microwave will start to cook.
- **IMPORTANT: The inside of the oven and the food that you have been cooking may be extremely hot. So care should be taken when removing items from the cavity. We would recommend that you use an oven glove.**

- After the food has been removed from the cavity, you should make sure that the door is closed.

Grill fan cooking

- Place whatever you are cooking in the centre of the microwave cavity and then close the microwave door. **IMPORTANT: You should make sure that the door of the microwave is shut securely.**



- Turn the cooking function selection dial **(1)** once clockwise to select cooking mode. Use the adjustment dial **(8)** to select the grill fan function. The default temperature set is 180°C.



- **IMPORTANT: You must select the cooking function within 10 seconds or the displayed default setting will be programmed.**
- Press the temperature setting button **(5)** to change the temperature. Turn the adjustment dial **(8)** to select the required temperature from 100 - 230°C increasing in 5°C intervals. The maximum temperature is 230°C and the minimum temperature is 100°C.
- Press the timer button **(6)** to change the cooking time. The default time set is 10 minutes. Turn the adjustment dial **(8)** to select the required cooking time. The maximum time is 5 hours.
- Press the start / stop button **(7)** and the oven will begin to heat.
- **IMPORTANT: The inside of the oven and the food that you have been cooking may be extremely hot. So care should be taken when removing items from the cavity. We would recommend that you use an oven glove.**
- After the food has been removed from the cavity, you should make sure that the door is closed.

Bottom – heat fan cooking

- Place whatever you are cooking in the centre of the microwave cavity and then close the microwave door. **IMPORTANT: You should make sure that the door of the microwave is shut securely.**

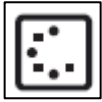

- Turn the cooking function selection dial **(1)** once clockwise to select cooking mode. Use the adjustment dial **(8)** to select the bottom – grill fan function. The default temperature set is 180°C.
- **IMPORTANT: You must select the cooking function within 10 seconds or the displayed default setting will be programmed.**
- Press the temperature setting button **(5)** to change the temperature. Turn the adjustment dial **(8)** to select the required temperature from 100 - 230°C increasing in 5°C intervals. The maximum temperature is 230°C and the minimum temperature is 100°C.
- Press the timer button **(6)** to change the cooking time. The default time set is 10 minutes. Turn the adjustment dial **(8)** to set the required cooking time. The maximum time is 5 hours.
- Press the start / stop button **(7)** and the oven will begin to cook.
- **IMPORTANT: The inside of the oven and the food that you have been cooking may be extremely hot. So care should be taken when removing items from the cavity. We would recommend that you use an oven glove.**
- After the food has been removed from the cavity, you should make sure that the door is closed.

Combination cooking

Microwave and grill cooking

- Place whatever you are cooking in the centre of the microwave cavity and then close the microwave door. **IMPORTANT: You should make sure that the door of the microwave is shut securely.**



- Turn the cooking function selection dial **(1)** twice clockwise to select combination cooking mode. When the microwave symbol and the cooking symbol appear on the LED display this means the oven has entered the correct mode.
- Use the adjustment dial to select the grill function. The default power set is MAX.
- **IMPORTANT: You must select the cooking function within 10 seconds or the displayed default setting will be programmed.**
- Press the temperature setting button **(5)** to change the grill temperature. Use the adjustment dial **(8)** to select the desired power level for the grill. There are 3 power levels with MAX as the third and MIN as the first.
- Press the microwave power button **(2)** to change the power level for the microwave. Use the adjustment dial **(8)** to set a power level from the following choices: 700W – 450W – 300W – 100W.
- Press the timer button **(6)** to change the cooking time. The default time set is 10 minutes. Use the adjustment dial **(8)** to set the required cooking time. The maximum time is 90 minutes.
- Press the start / stop button **(7)** and the oven will begin cooking.
- **IMPORTANT: The inside of the oven and the food that you have been cooking may be extremely hot. So care should be taken when removing items from the cavity. We would recommend that you use an oven glove.**
- After the food has been removed from the cavity, you should make sure that the door is closed.

Microwave and convection cooking

- Place whatever you are cooking in the centre of the microwave cavity and then close the microwave door. **IMPORTANT: You should make sure that the door of the microwave is shut securely.**



- Turn the cooking function selection dial **(1)** twice clockwise to select combination cooking mode. When the microwave symbol and the cooking symbol appear on the LED display this means the oven has entered the correct cooking mode.
- Use the adjustment dial **(8)** to select the convection cooking function. The default temperature set is 180°C.
- **IMPORTANT: You must select the cooking function within 10 seconds or the displayed default setting will be programmed.**
- Press the temperature setting button **(5)** to set the convection oven temperature. Use the adjustment dial **(8)** to set a temperature from 50 - 230°C. The maximum temperature is 230°C and the minimum temperature is 50°C.
- Press the microwave power button **(2)** to change the power level of the microwave. The default power set is 300W. Turn the adjustment dial **(8)** to set the required power level from the following options: 700W - 450W - 300W - 100W.
- Press the timer button **(6)** to change the cooking time. The default time set is 10 minutes. Turn the adjustment dial **(8)** to set the required cooking time. The maximum time is 90 minutes.
- Press the start / stop button **(7)** and the oven will begin to cook.
- **IMPORTANT: The inside of the oven and the food that you have been cooking may be extremely hot. So care should be taken when removing items from the cavity. We would recommend that you use an oven glove.**
- After the food has been removed from the cavity, you should make sure that the door is closed.

Microwave and grill fan cooking

- Place whatever you are cooking in the centre of the microwave cavity and then close the microwave door. **IMPORTANT: You should make sure that the door of the microwave is shut securely.**

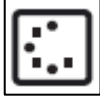

- Turn the cooking function selection dial **(1)** twice clockwise to select combination cooking mode. When the microwave symbol and the cooking symbol appear on the LED display this means the oven has entered the correct cooking mode.



- Turn the adjustment dial **(8)** to select the grill fan function. The default temperature set is 180°C.

- **IMPORTANT: You must select the cooking function within 10 seconds or the displayed default setting will be programmed.**
- Press the temperature setting button **(5)** to change the grill fan temperature. Use the adjustment dial **(8)** to select the required temperature from 100 - 230°C increasing in 5°C intervals. The maximum temperature is 230°C and the minimum temperature is 100°C.
- Press the microwave power button **(2)** to change the power level for the microwave. The default power level is 300W. Use the adjustment dial **(8)** to set the required power level from the following options: 700W – 450W – 300W – 100W.
- Press the timer button **(6)** to change the cooking time. The default time set is 10 minutes. Turn the adjustment dial **(8)** to set the required cooking time. The maximum cooking time is 90 minutes.
- Press the start / stop button **(7)** and the oven will begin cooking.
- **IMPORTANT: The inside of the oven and the food that you have been cooking may be extremely hot. So care should be taken when removing items from the cavity. We would recommend that you use an oven glove.**
- After the food has been removed from the cavity, you should make sure that the door is closed.

Microwave and bottom-heat cooking

- Place whatever you are cooking in the centre of the microwave cavity and then close the microwave door. **IMPORTANT: You should make sure that the door of the microwave is shut securely.**



- Turn the cooking function selection dial **(1)** twice clockwise to select combination cooking mode. When the microwave symbol and the cooking symbol appear on the LED display this means that the oven has entered the correct cooking mode.
- Turn the adjustment dial **(8)** to select the bottom-grill cooking function. The default temperature set is 180°C.
- **IMPORTANT: You must select the cooking function within 10 seconds or the displayed default setting will be programmed.**
- Press the temperature setting button **(5)** to change the temperature for the bottom-heat element. Use the adjustment dial **(8)** to set the required temperature from 100 - 230°C increasing in 5°C intervals. The maximum temperature is 230°C and the minimum temperature is 100°C.
- Press the microwave power button **(2)** to change the power setting of the microwave. The default power level is 300W. Use the adjustment dial **(8)** to set the required power level from the following options: 700W – 450W – 300W – 100W.
- Press the timer button **(6)** to change the cooking time. The default cooking time is 10 minutes. Use the adjustment dial **(8)** to set the required cooking time. The maximum time is 90 minutes.
- Press the start / stop button **(7)** and the oven will begin to cook.
- **IMPORTANT: The inside of the oven and the food that you have been cooking may be extremely hot. So care should be taken when removing items from the cavity. We would recommend that you use an oven glove.**
- After the food has been removed from the cavity, you should make sure that the door is closed.

Other functions

Auto-menu cooking

There are 15 automatic cooking programs on your appliance. You only have to choose the program and set the weight to begin cooking. The power, time and temperature are already programmed to achieve optimum cooking results. To select a cooking program follow the steps below:

- Press the ON / OFF button **(4)** to activate the microwave function.
- Turn the cooking function selection dial **(1)** three times clockwise to select the auto-cooking mode.
- The time, weight and the first number of the automatic programs are shown on the display.
- Use the adjustment dial **(8)** to select an auto program.
- Press the auto menu setting button **(5)** to confirm the menu choice.
- Then press the weight setting button **(2)**. Use the adjustment dial **(8)** to select the required weight of the food.
- Press the start / stop button **(7)** to begin the cooking process.

Defrost function



- Turn the cooking function selection dial **(1)** four times clockwise to select defrost mode. When the defrost symbol appears on the LED display this means that the oven has entered the correct mode.
- Use the adjustment dial **(8)** to select the defrost program required. "d01" and "d02" will display in order.
- Press the weight setting button **(2)** to program the weight of the food. Use the adjustment dial **(8)** to set the correct weight of the food.
- Press the start / stop button **(7)** to begin the defrosting function.

For a description of the auto-cooking programs available please see the table below:

Program	Category	Default weight (kg)	Item
D01 (defrost) **	Meat, poultry and fish	0.20	If you hear a beep, the combi microwave oven stops. Turn the food and press the start / stop button to continue the defrosting program.
D02 (defrost) **	Bread, cake and fruit	0.10	
P01 **	Vegetables	0.30	Fresh vegetables.
P02 **	Side dishes	0.50	Potatoes – peeled / cooked.
P03 *	Side dishes	0.20	Potatoes – roasted. If you hear a beep, turn the food. The combi microwave oven starts the next phase automatically.
P04	Poultry / fish	0.20	Chicken pieces / fish pieces. If you hear a beep, turn the food. The combi microwave oven starts the next phase automatically.
P05 *	Bakery	0.50	Cake.
P06 *	Bakery	1.00	Apple pie.
P07 *	Bakery	0.50	Quiche.
P08 **	Reheat	0.10	Drink / soup.
P09 **	Reheat	0.20	Plated meal.
P10 **	Reheat	0.20	Sauce / stew / dishes.
P11 *	Convenience	0.10	Frozen – pizza.
P12 *	Convenience	0.20	Oven chips. If you hear a beep, turn the food. The combi microwave oven starts the next phase automatically.
P13 *	Convenience	0.30	Frozen – lasagne.

* These programs are preheated. During preheating, the cooking time pauses and the preheating symbol turns on. After preheating, you will hear an alarm and the preheating symbol will flash.

** These programs use only the microwave function.

Preheating function

Most of the cooking functions will require a preheating cycle beforehand to ensure the oven is properly heated before food is introduced into the cavity.

- After setting the required oven function as outlined in the instructions above, press the preheating function button **(3)**.
- Press the start / stop button **(7)** to begin the preheating part of the cooking process.
- If the door is opened during this process, the preheating function will be cancelled.
- When the required temperature is reached, an alarm will sound 3 times. To silence the alarm, press the start / stop button **(7)**. The alarm will turn off automatically after 2 hours.
- Press the start / stop button **(7)** to begin the cooking part of the selected function.

Safety-lock

To protect the microwave oven from unwanted adjustments and tampering when it is not in use, a safety-lock can be activated.

- Press the start / stop button **(7)** and the temperature setting button **(5)** simultaneously for 3 seconds. There will be a long beep which indicates that the safety-lock has been activated.
- To deactivate the safety-lock, press the start / stop button **(7)** and the temperature setting button **(5)** simultaneously for 3 seconds again. There will be a long beep which indicates the safety-lock has been released.

Microwave cooking guidelines

- If you are heating liquid in the microwave, then you must also place a teaspoon in the container. This will ensure that the liquid does not boil suddenly after being removed from the microwave cavity.



- This phenomenon is called “delayed boiling”, this means that a liquid can be close to boiling point, even if there is no steam coming off the liquid or the liquid is not bubbling. If the liquid container is even gently shaken, then the liquid can without warning boil over or even spurt. This could **scald the end user**.
- Liquids and other foods must not be heated in sealed containers as they are liable to explode.
- If the food you are cooking has a skin or peel (e.g. sausages, tomatoes, potatoes etc), then you should pierce the skin or peel with a fork. This will ensure that if steam is created during the heating process, it can escape and the food will not burst.
- When heating baby food, the bottle or jar containing the food should **NEVER** have a top or lid on. After cooking, to ensure that the food has been heated uniformly, you should stir or shake the food. **IMPORTANT: You must check the temperature of the food before feeding it to a child.**
- When heating food in a microwave, it will transmit the heat to the container that the food is in or on. You should **ALWAYS** use oven gloves when removing items from the microwave.
- You should make sure that you do not cook food for too long or at too high a power level. This could cause certain areas of the food to dry out or even ignite.
- You should not use ceramic or porcelain crockery, or porous earthenware inside of your microwave. These dishes could absorb moisture from the food whilst it is cooking, which could cause pressure to build up and shatter the dish.
- If you are heating certain foods and any liquid, moisture will evaporate and condensation may occur. This does not indicate that the appliance is faulty and it can be particularly noticeable if the ambient temperature of the room is high.
- **IMPORTANT: Any condensation should be wiped up with a soft cloth as soon as you have finished using the microwave.**
- After the cooking time has completed, you should let the food stand for a few minutes. This is called “standing time” and will allow the heat generated by the microwave to spread evenly throughout the food.

Materials you can use for microwave cooking

Material	Remarks
Aluminium foil	To be used for shielding only. Small smooth pieces can be used to cover thin parts of meat or poultry to prevent overcooking. Arcing can occur if foil is too close to the cavity walls. The foil should be at least 2.5 cm away from the cavity walls.
Browning dish	Follow the manufacturer's instructions. The bottom of the browning dish must be at least 5 mm thick above the turntable. Incorrect usage may cause the turntable to break.
Dinnerware	Microwave-safe only. Follow the manufacturer's instructions. Do not use cracked or chipped dishes.
Glass jars	Always remove the lid. Use only to heat food until just warm. Most glass jars are not heat resistant and may break.
Glassware	Heat-resistant oven glassware only. Make sure there is no metallic trim. Do not use cracked or chipped dishes.
Oven cooking bags	Follow the manufacturer's instructions. Do not close with a metal tie. Make slits in the bag to allow steam to escape.
Paper plates and cups	Use for short-term cooking/warming only. Do not leave the oven unattended whilst cooking.
Paper towels	Use to cover food for reheating and absorbing fat. Use under supervision and for short-term cooking only.
Parchment paper	Use as a cover to prevent splattering or as a wrap for steaming
Plastic	Microwave-safe only. Follow the manufacturer's instructions. It should be labelled as "microwave safe". Some plastic containers soften as the food inside gets hot. "Boiling bags" and tightly closed plastic bags should be slit, pierced or vented, as described by the package.
Plastic wrap	Microwave-safe only. Use to cover food during cooking to retain moisture. Do not allow the plastic wrap to touch the food.
Thermometers	Microwave-safe only. Meat and candy thermometers.
Wax paper	Use as a cover to prevent splattering and to retain moisture.

Materials you cannot use for microwave cooking

Material	Remarks
Aluminium tray	May cause arcing. Transfer food into a microwave-safe dish.
Food carton with metal handle	May cause arcing. Transfer food into a microwave-safe dish.
Metal or metal-trimmed utensils	Metal shields the food from microwave energy. The metal trim may cause arcing.
Metal twist ties	May cause arcing and could cause a fire in the oven.
Paper bags	May cause a fire in the oven.
Plastic foam	Plastic foam may melt or contaminate the liquid inside when exposed to a high temperature.
Wood	Wood will dry out when used in the microwave oven and may split or crack.

Utensils table

Cookware	Microwave	Grill	Combination*
Heat-resistant glass	Yes	Yes	Yes
Non heat-resistant glass	No	No	No
Heat-resistant ceramics	Yes	Yes	Yes
Microwave-safe plastic dish	Yes	No	No
Kitchen paper	Yes	No	No
Metal tray	No	Yes	No
Metal rack	No	Yes	No
Aluminium foil and foil containers	No	Yes	No

* Combination mode applies to microwave + grill and microwave + convection modes.



Cleaning operations must only be carried out when the oven is cool.

The appliance should be disconnected from your mains supply before commencing any cleaning process.

The appliance exterior

- You should wipe over the front of the appliance with a soft cloth and warm water mixed with a little washing up liquid.
- ***DO NOT*** use abrasive cleaners or sharp objects to clean the front surface of the microwave.

The appliance interior

- You should wipe over the inside of the appliance with a soft cloth and warm water mixed with a little washing up liquid.
- You should pay particular attention to the door seal and the surrounding area.
- ***DO NOT*** use abrasive cleaners or sharp objects to clean the inside of the microwave.

Turntable and turntable support

- The turntable and wire rack should be removed from the microwave for cleaning purposes after each use.
- Clean the turntable and wire rack in warm water mixed with a little washing up liquid.

General cleaning advice

- ***IMPORTANT:*** Any condensation should be wiped up with a soft cloth as soon as you have finished using the microwave.
- To remove odours from inside of the microwave, you should boil one cup of water mixed with several tablespoons of lemon juice inside of the cavity.

- The microwave should be thoroughly cleaned before it is operated for the first time and after each use. This will avoid residual food stuffs becoming baked on the oven cavity. After residues have been baked on several times, they are far more difficult to remove.
- **Never** clean the oven surfaces by steam cleaning.
- If you use any form of oven cleaner on your appliance, then you must check with the manufacturer of the cleaner that it is suitable for use on your appliance.
- **Any damage that is caused to the appliance by a cleaning product will not be fixed by Baumatic free of charge, even if the appliance is within the guarantee period.**

Installation



The installation must be carried out by a suitably qualified person, in accordance with the current version of the following.

- UK Regulations and Safety Standards or their European Norm Replacements.
- **Building Regulations** (issued by the Department of the Environment).
- **Building Standards** (issued by the Scottish Development Department).
- **IEE Wiring Regulations.**
- **Electricity At Work Regulations.**

Electrical connection



YOUR MICROWAVE IS INTENDED FOR FITTED AND PERMANENT INSTALLATION.

- Before connecting the appliance, make sure that the supply voltage marked on the rating plate corresponds with your mains supply voltage.
- We recommend that the appliance is connected by a qualified electrician, who is a member of the N.I.C.E.I.C. and who will comply with the I.E.E. and local regulations.
- **WARNING: THIS APPLIANCE MUST BE EARTHED.**

- This appliance is supplied with a mains supply cable. It must be wired into a 16 A double pole switched fused spur outlet, having 3 mm contact separation and placed in an easily accessible position adjacent to the appliance. The spur outlet must still be accessible even when your microwave is located in its housing.
- The wiring in the mains lead is coloured as follows:

Brown	Live
Blue	Neutral
Green and yellow	Earth

- As the colours of the wires in the appliance's mains lead may not correspond with the coloured markings identifying the terminals in your spur box, please proceed as follows:

The **brown wire** must be connected to the terminal marked "L" (live), or coloured **red**.

The **blue wire** must be connected to the terminal marked "N" (neutral), or coloured **black**.

The **green and yellow wire** must be connected to the terminal marked "E" (earth), or by the earth symbol, or coloured **green and yellow**.

- When the connection is completed, no stray strands or cut wire should be present. The cord clamp must be secured over the outer sheath.
- Broken or damaged power leads must only be replaced by a suitably qualified person. A power lead of a similar type must be used in replacement.



Before beginning to install your appliance, check that there is no sign of damage (on the inside or the outside of the microwave), and that there are no packing materials or accessories inside the cavity. Remove any protective film on the microwave.

Aperture and ventilation requirements

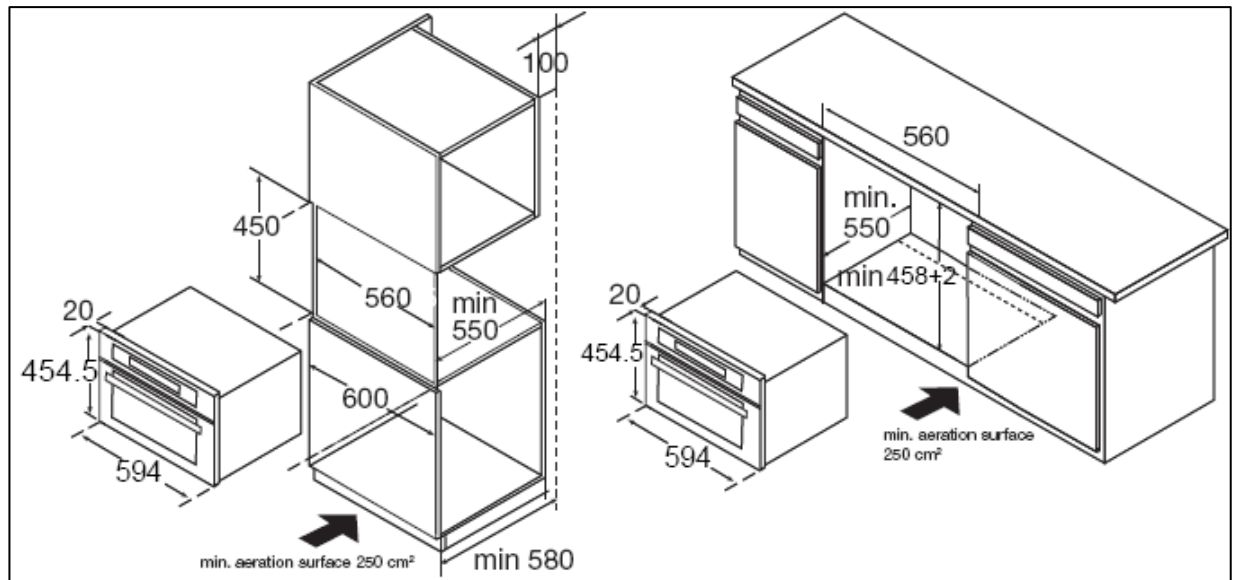

- The diagram above shows the aperture and ventilation requirements that you require to build the appliance into a housing unit.
- Ensure that the rear panel of the furniture housing unit has been removed.
- This oven may be installed without any additional ventilation cut outs being made in the housing unit. However the ventilation cut shown in the diagram **MUST** be present, otherwise the microwave oven may not function correctly. At the rear and sides keep at least 43 mm free.
- Do not cover the ventilation slots or air intake points.
- The adjustable feet should not be removed.
- Do not position the microwave oven near a heat source. Please note that transmitting and receiving equipment such as radios and televisions can affect the operation of the microwave oven.

Fixing the appliance into the housing unit

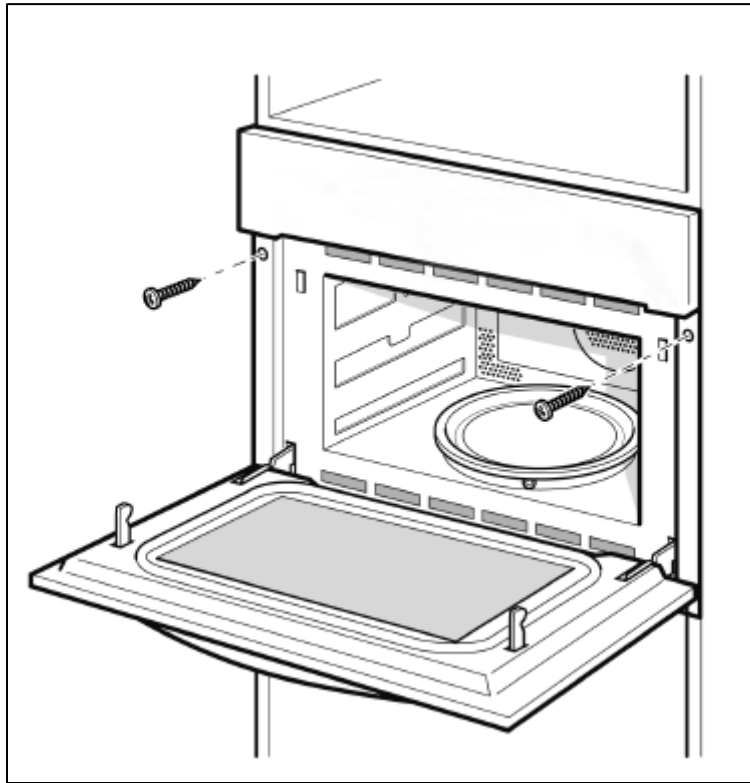

IMPORTANT: NO OTHER METHODS OF INSTALLING THE MICROWAVE ARE SANCTIONED BY BAUMATIC.

- Fully insert the appliance into the aperture hole and centre it.
- Ensure that none of the cables are kinked or compressed when the appliance is in position.
- Screw the appliance to the aperture using the fixing screws.
- The gap between the housing unit and the appliance must not be closed by additional plinths.
- **WARNING: The microwave will get hot during operation; care should be taken not to accidentally come into contact with the outer surface.**
- **WARNING: Children should not be allowed near to the appliance unsupervised.**

Troubleshooting

- ***The microwave will not switch on.***
 - * Check that the appliance has been connected to the mains supply correctly.
 - * Check that the fuse in the moulded plug has not blown.
 - * Check that the fuses in your fuse box have not blown.
 - * If fuses blow on a regular basis, then we would recommend that you consult with a qualified electrician.
 - * Check that there has not been a power cut.

- ***The microwave will not start cooking.***
 - * Check that the door is properly shut.
 - * Check that the door seal and surrounding area are clean.
 - * Check that you have pressed start / stop button.

- ***The turntable is not turning.***
 - * Check that the turntable is connected to the drive motor correctly.
 - * Check that the ovenware is not larger than the turntable glass.
 - * Check that the food you are cooking does not extend beyond the turntable glass.
 - Check that there is nothing underneath the turntable that is preventing it from turning.

- ***The microwave does not switch off.***
 - * Isolate the microwave from your mains supply and then contact the Baumatic Customer Care Department.

- ***The interior light bulb is not working.***
 - * Call the Baumatic Customer Care Department. The interior light bulb can only be replaced by a trained service technician.

- ***My food is not cooking properly.***
 - * Check that the power level and cooking time that you have set, is appropriate for the food that you are cooking.
 - * If you are cooking a double amount of food, then you will normally need to almost double the cooking time.
 - * If the food that you have placed in the cavity is colder than normal, then the power level and cooking time may need to be increased.

- ***I am getting condensation in my oven.***
- * Steam and condensation are a natural by product of cooking in a microwave.
- * Do not leave food in the oven to cool after it has been cooked and the oven has been switched off.
- * Use a covered container, where practical, when cooking to reduce the amount of condensation that forms.
- * You should wipe over any condensation that has formed, as soon as the food has stopped cooking.



IMPORTANT: If your appliance appears not to be operating correctly, then you should disconnect it from your mains supply and then contact Baumatic Customer Care on telephone number (0118) 933 6911.

DO NOT ATTEMPT TO REPAIR THE APPLIANCE YOURSELF.

Please note that if an engineer is asked to attend whilst the product is under guarantee and finds that the problem is not the result of an appliance fault, then you may be liable for the cost of the call out charge.

The appliance must be accessible for the engineer to perform any necessary repair. If your appliance is installed in such a way that an engineer is concerned that damage will be caused to the appliance or your kitchen, then he will not complete a repair.

This includes situations where appliances have been tiled in, sealed in with sealant, have wooden obstructions placed in front of the appliance, like plinths. Or any installation other than the one specified by Baumatic Ltd. has been completed.

Please refer to the conditions of guarantee that appear on the warranty card that you receive with the appliance.

IMPORTANT: Baumatic Ltd. operates a policy of continuous improvement and reserves the right to adjust and modify its products without prior notification.



United Kingdom

Baumatic Ltd.,
Baumatic Buildings,
6 Bennet Road,
Reading, Berkshire
RG2 0QX
United Kingdom

Sales Telephone

(0118) 933 6900

Sales Fax

(0118) 931 0035

Customer Care Telephone

(0118) 933 6911

Customer Care Fax

(0118) 986 9124

Spares Telephone

(01235) 437244

Advice Line Telephone

(0118) 933 6933

E-mail:

sales@baumatic.co.uk
customercare@baumatic.co.uk
spares@baumatic.co.uk
technical@baumatic.co.uk

Website:

www.baumatic.co.uk

Republic of Ireland

Service Telephone

1-890 812 724

Spares Telephone

091 756 771

Czech Republic

Baumatic CR spol s.r.o.
Průmyslová zóna Sever 696
460 11 Liberec 11
Czech Republic

+420 483 577 200

www.baumatic.cz

Slovakia

Baumatic Slovakia, s.r.o.
Galvániho 7/D
Slovakia

+421 255 640 618

Germany

Baumatic Gmbh
Lilienthalstrasse 1
320 52 Herford
Deutschland

+49 5221 694 99-0

www.baumatic.de

Italy

Baumatic Italia S.R.L.
Via Galvani N.3
35011 Campodarsego (PD)

+3904 9920 2297

www.baumatic.it

Holland

Baumatic Benelux B.V.
Grindzuigerstraat 22
1333 MS ALMERE
Nederland

+3136 549 1555

www.baumatic.nl

