

**BHI625 60cm
Induction hob with
slider**

INSTRUCTION MANUAL

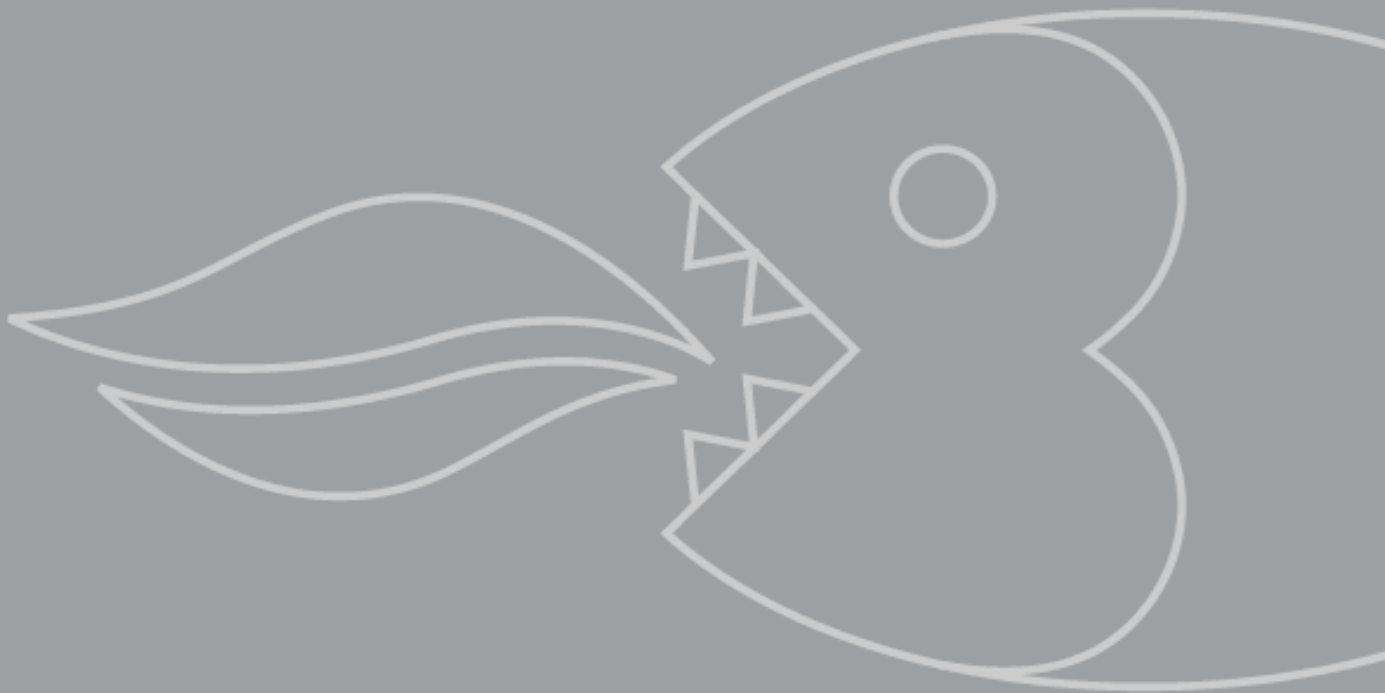

User Manual for your Baumatic

BHI625

60 cm Induction hob with slider

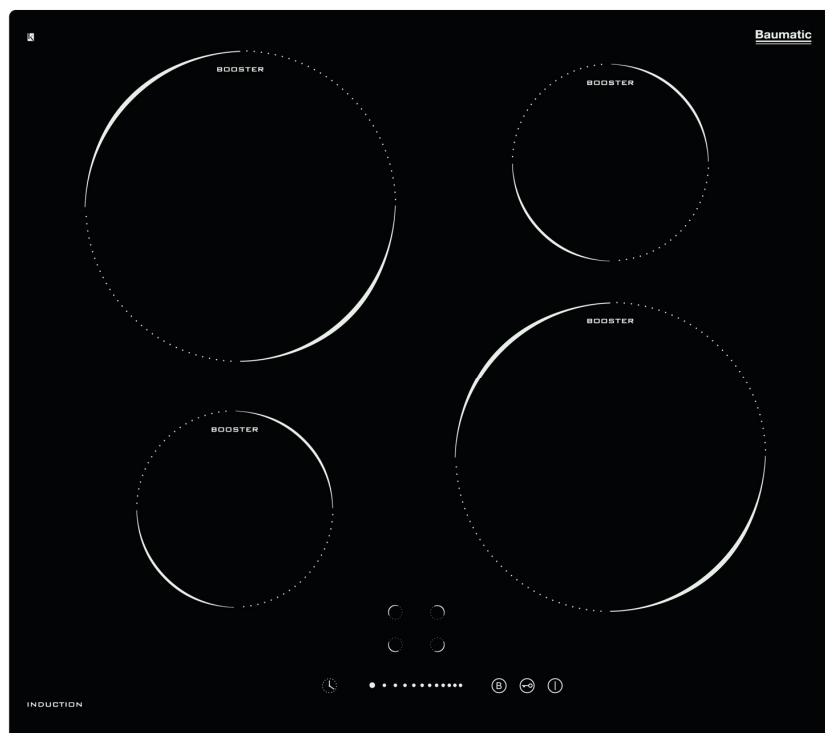

NOTE: This User Instruction Manual contains important information, including safety & installation points, which will enable you to get the most out of your appliance. Please keep it in a safe place so that it is easily available for future reference; for you or any person not familiar with the operation of the appliance.

GS 18/05/12

Contents

Environmental note	4
Important safety information	5 – 8
Specifications	9 – 11
Product and aperture dimensions	9
Product specifications	9
Electrical details	10
Ceramic hob surface layout	10
Control panel layout	11
Using the ceramic hob	11 - 22
Before first use	11
Touch controls	12
Switching the hob on	12
Switching on a zone and setting a power level	13 – 14
Power levels	14
Switching off a zone	14 - 15
Switching the hob off	15
Residual heat indicator	15
Pan sensor	15 - 16
Cookware that is suitable for an induction hob	16
The boost function	16 - 17
The hob timer (minute minder)	17 – 18
The hob timer (linked to a cooking zone)	18 – 20
Cancelling a timer function	20
Locking the hob top	20 - 21
Safety cut-off	21
High temperature protection	21
Hob guidelines	21 - 22
Cleaning and maintenance	22 - 24
Cleaning the ceramic hob top	22 - 23
After each use	23
Cleaning table	23
Using a ceramic hob scraper	23 - 24
Using a specialist ceramic hob cleaner	24
Installation	24 - 30
Positioning	24 - 25
Unpacking the appliance	25
Installing the appliance	26– 27
Electrical connection	27 - 28
Connecting the mains supply cable	28
Replacing the mains supply cable	29
My appliance isn't working correctly	29 - 31
Error codes	30 - 31
Baumatic consumables	32
Contact details	33

Environmental note

This appliance is marked according to the European directive 2002/96/EC on Waste electrical and Electronic Equipment (WEEE). By ensuring this product is disposed of correctly, you will help prevent potential negative consequences for the environment and human health, which could otherwise be caused by inappropriate waste handling of this product.

The symbol  on the product, or on the documents accompanying the product, indicates that this appliance may not be treated as household waste. Instead it shall be handed over to the applicable collection point for the recycling of electrical and electronic equipment.

Disposal must be carried out in accordance with local environmental regulations for waste disposal.

For more detailed information about treatment, recovery and recycling of this product, please contact your local city office, your household waste disposal service or the shop where you purchased the product.



- The packaging materials that Baumatic uses are environmentally friendly and can be recycled.
- Please discard all packaging material with due regard for the environment.

Important safety information



Your safety is of the utmost importance to Baumatic. Please make sure that you read this instruction booklet **before** attempting to install or use the appliance. If you are unsure of any of the information contained in this booklet, please contact the Baumatic Advice Line.

General Information

- This appliance is designed for domestic household use and for the cooking and frying of domestic foodstuffs.
- **IMPORTANT:** *The adjacent furniture and all materials used in the installation **must** be able to withstand a minimum temperature of 85°C above the ambient temperature of the room it is located in, whilst in use.*
- Certain types of vinyl or laminate kitchen furniture are particularly prone to heat damage or discolouration at temperatures below the guidelines given above.
- Any damage caused by the appliance being installed in contravention of this temperature limit, **will be the liability of the owner.**
- Your new appliance is guaranteed against electrical or mechanical defects, subject to certain exclusions that are noted in Baumatic's Conditions Of Guarantee. The foregoing does not affect your statutory rights.
- The use of this appliance for any other purpose or in any other environment without the express agreement of Baumatic Ltd. will invalidate any warranty or liability claim.
- You should not use this appliance to store items on or as a work surface.
- No modifications to the appliance are permitted by Baumatic Ltd.
- You should not store or place flammable or highly flammable liquids/materials on top of or near the appliance. Items made from aluminium, plastic or plastic film should also be kept away from the appliance, as they may fuse to the surface.
- **Repairs may only be carried out by Baumatic service engineers or their authorised service agent.**

Child Safety

- Baumatic strongly recommend that babies and young children are prevented from being near to the appliance and not allowed to touch the appliance **at any time**. During and after use, all surfaces will be hot.
- If it is necessary for younger family members to be in the kitchen, please ensure that they are kept under close supervision at all times.
- Older children should only be allowed to utilise the appliance when supervised.

General Safety

- The appliance should only be installed and connected by a suitably qualified person.
- Care should be taken to ensure that the units and work surfaces that you build the appliance into, meet with the relevant standards.
- If you notice any scratches, splits or cracks in the ceramic glass, you should immediately switch off the appliance and disconnect it from your mains supply. Otherwise there is the risk of electric shock occurring.

During use

- Any film or stickers that are present on the hob surface when it is delivered should be removed before use.
- Care should be taken when utilising the appliance, otherwise there is a risk of burns being caused.
- You should not allow the electrical connection cables to come into contact with the hob surface when it is hot or any hot cookware.
- If fat and oil overheats, then it can ignite extremely quickly. For this reason, when cooking with fat and oil the appliance should not be left unattended.
- Make sure that all of the cooking zones are switched off after use.

- **IMPORTANT:** *This ceramic induction hob fully complies with current legislation regarding electro-magnetic interference and is designed not to interfere with other electronic appliances providing these comply with the same legislation.*
- *As the hob generates magnetic fields in its immediate vicinity, pacemakers and active heart implants must be designed to comply with relevant regulations. If in doubt, you should consult the manufacturer of your device or your doctor. In this respect, Baumatic can only guarantee the conformity of our own product.*
- *If an object made of metal, (e.g. saucepan lid, knife, fork or spoon) is placed on a cooking zone that is switched on, it can get hot.*

Cleaning

- Cleaning of the hob should be carried out on a regular basis.
- **IMPORTANT:** *Before attempting to clean the appliance, it should be disconnected from the mains and allowed to cool.*
- Great care should be taken whilst using this appliance and when following the cleaning procedure.
- You should not use a steam jet or any other high pressure cleaning equipment to clean the appliance.

Installation



This appliance must be correctly installed by a suitably qualified person, strictly in accordance with the manufacturer's instructions. Please see the specific section of this booklet that refers to installation.

Baumatic Ltd. declines any responsibility for injury or damage, to person or property, as a result of improper use or incorrect installation of this appliance.

Declaration of conformity

This appliance complies with the following European Directives:

- 2006/95/CE General regulations / Low tension
 - 1935/2004/CE 90/128/EEC This appliance is suitable to come in contact with food
 - 2004/108/CE Electromagnetic compatibility
- The manufacturer declares that the hob is built using certified materials and requires the appliance to be installed in accordance with the standards currently in force. This appliance must be used by a trained person for domestic purposes only.

To avoid damaging your appliance

- The ceramic glass can be damaged by objects falling onto it.
- The ceramic glass edge can be damaged by knocks from cookware.
- Cast iron and cast aluminium cookware with damaged bases may scratch the ceramic surface if they are dragged across it.
- Pans should be lifted on and off the hob surface and not dragged.
- Cooking zones should not be switched on without cookware placed on it. Also the cookware should not be empty.
- Food or liquid that has high sugar content may damage the hob top, if it comes into contact with the ceramic hob surface. Any spillages should be wiped up immediately, however this may not prevent the hob surface from becoming damaged.

Specifications

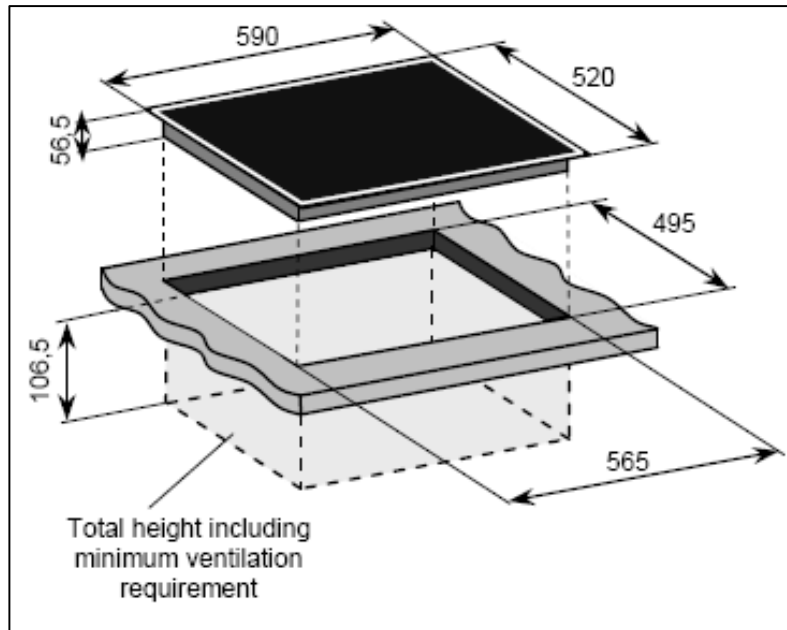

Product dimensions:

Depth: 520 mm
Width: 590 mm
Height: 56.5 mm

Aperture dimensions:

Depth: 495 mm
Width: 565 mm
Height: 106.5 mm

Product specifications:

- 2 x 2.30 kW induction zones with booster (2.60 kW) Ø 220 mm
- 2 x 1.20 kW induction zones with booster (1.50 kW) Ø 140 mm
- 1 x 1.50 kW induction zone (Ø 180 mm)
- 1 x 1.50 kW induction zone (Ø 140 mm)

- Front touch slider control operation
- Safety lock
- 4 individual residual heat indicators
- 4 independent induction generators
- Electronic timer
- Pan compatibility detection
- Frameless

Standard accessories

- Ceramic hob scraper

Electrical details

Rated Voltage:	220 - 240 Vac 50 - 60 Hz
Supply Connection:	30 A (double pole switched fused outlet with 3mm contact gap)
Max Rated Inputs:	7.60 kW
Mains Supply Lead:	3 core x 6 mm ² (not supplied)

For future reference please record the following information which can be found on the rating plate and the date of purchase which can be found on your sales invoice. The rating plate of your hob is located on the underneath of the appliance. Therefore it is a good idea to record this information before you install your appliance.

Model Number

Serial Number

Date of Purchase

Ceramic hob surface layout

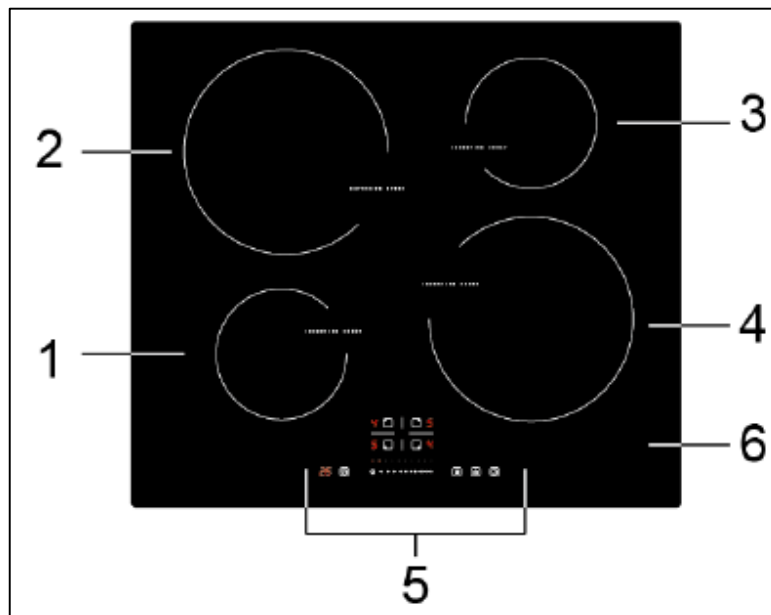

- 1)** 1.20 kW induction zone with booster (1.50 kW) Ø 140 mm
- 2)** 2.30 kW induction zone with booster (2.60 kW) Ø 220 mm
- 3)** 1.20 kW induction zone with booster (1.50 kW) Ø 140 mm
- 4)** 2.30 kW induction zone with booster (2.60 kW) Ø 220 mm
- 5)** Control panel
- 6)** Hob surface

Control panel layout

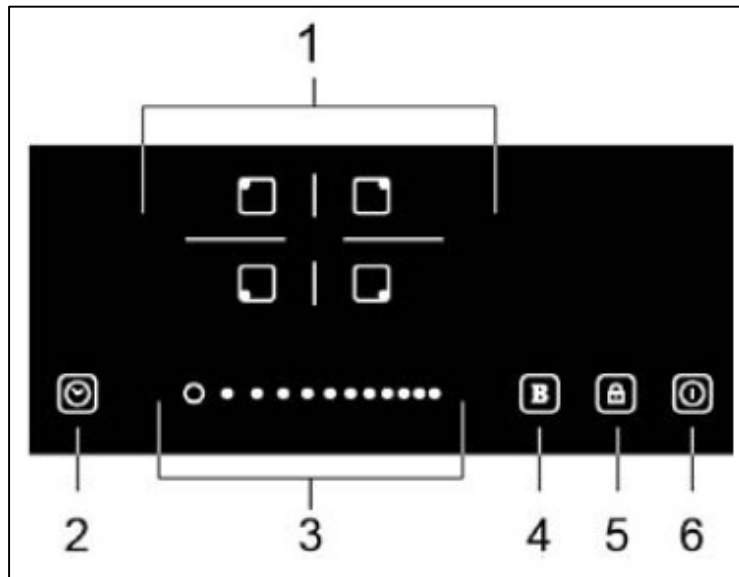

- 1) Cooking zone selection buttons
- 2) Timer button
- 3) Slider control
- 4) Booster button
- 5) Safety lock button
- 6) ON/OFF button

Using the ceramic hob

Before first use



IMPORTANT: You should clean the ceramic hob surface (see "Cleaning and maintenance" section).

- You should switch on one cooking zone at a time for 5 minutes at the maximum setting. This will help to eliminate any new smell that exists and evaporate any humidity that has formed on the heating elements during transit.
- Do not burn off more than one zone at once.
- **You must** place a saucepan filled half full with cold water on each zone as you burn it off. Otherwise the induction zone will not operate.

Touch controls

- All operations are performed by means of the touch controls that can be found on the control panel.
- The controls respond to touch so you do not need to add any pressure.
- You should use the ball of your finger not the tip when using the controls.

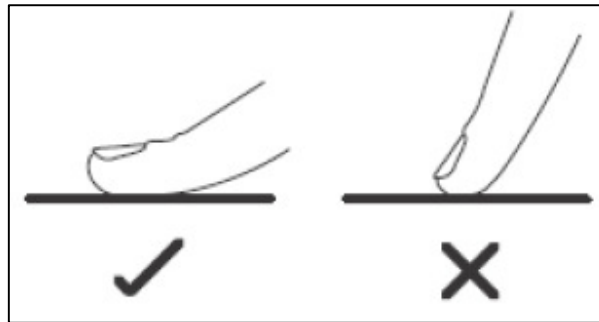

- A beep will sound each time a touch is registered.
- You should ensure that the controls are kept clean, dry and that no objects such as utensils or cloths cover them. Even a thin film of water may make the controls difficult to operate.

Switching the hob on

- When the hob is connected to a power supply, an audible signal will sound. All of the cooking zone indicators will show "-". The hob has now entered stand-by mode.



- Press the ON/OFF button.

Switching on a zone and setting a power level

IMPORTANT: A zone must be selected within 1 minute of turning the hob on.

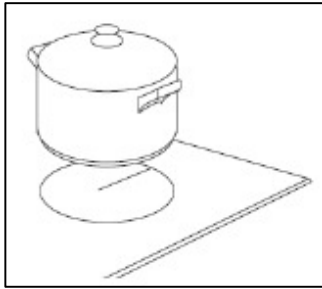

- Make sure that the bottom of the pan and the surface of the hob are clean and dry before placing a suitable pan on the cooking zone that you wish to use.

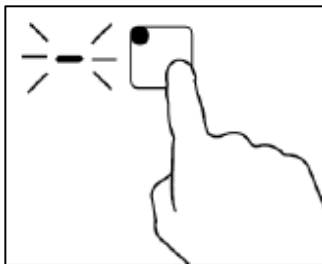

- Press the cooking zone selection button of the cooking zone that you want to use. An indicator next to the relevant button will flash.

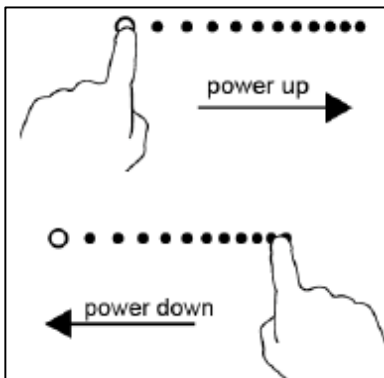

- Select the power level for the cooking zone that you have selected using the slider control. If you do not choose a heat setting within 1 minute of turning the hob on, the hob will switch off automatically.

- Sliding the slider control to the right will increase the power level while sliding the slider control to the left will decrease the power level. The power

level will show in the relevant display.

- You can alter the power level at any time during cooking using the slider control.

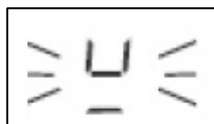

If the display flashes with the symbol shown opposite, alternatively with the heat setting, this means that:

- You have not placed a pan on the correct cooking zone or,
- The pan you are using is not suitable for induction cooking or,
- The pan is too small or not properly centred on the cooking zone.

- No heating will take place unless there is a suitable pan on the cooking zone. The display will automatically turn off after 2 minutes if no suitable pan is placed on it.

Power levels

- For a general guide to cooking various foods at the different power levels please refer to the table below.
- Please note that this table should be viewed as a guide only and that other factors such as cookware, weight and amount of food and personal preference will all influence the power level required.

Power Level	Recommended Use
1 - 2	<ul style="list-style-type: none"> ○ Delicate warming of small amounts of food. ○ Melting chocolate, butter and foods that burn quickly. ○ Gentle simmering. ○ Slow warming.
3 - 4	<ul style="list-style-type: none"> ○ Reheating. ○ Rapid simmering. ○ Cooking rice.
5 - 6	<ul style="list-style-type: none"> ○ Cooking pancakes.
7 - 8	<ul style="list-style-type: none"> ○ Sautéing. ○ Cooking pasta.
9	<ul style="list-style-type: none"> ○ Stir-frying. ○ Searing. ○ Bringing soup to the boil. ○ Boiling water.

Switching off a zone

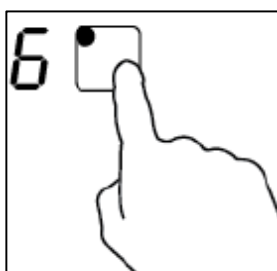

- Press the cooking zone selection button of the cooking zone that you want to switch off.

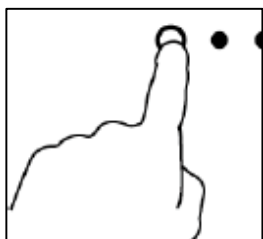

- Slide the slider control to the left to decrease the power level until it reaches the lowest position. The display should show power level "0".
- After a few seconds, the cooking zone will switch off.



- An "H" symbol will show in the cooking zone indicator until the surface has cooled down to a safe temperature (see the section on the "residual heat indicator" for further information).

Switching the hob off

Once you have switched off all of the cooking zones, you should switch the hob off.

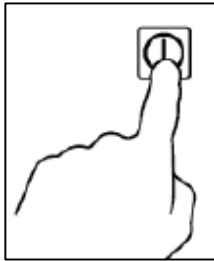

- Press the ON/OFF button.
- It is possible to turn the hob off at any time by pressing the ON/OFF button.

Residual heat indicator

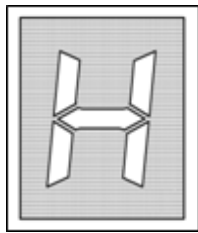

- After a zone is switched off, the corresponding cooking zone indicator will show a letter "H". This means that the temperature of the zone is over 60°C and is therefore still high enough to cause injury.
- **IMPORTANT:** *The residual heat indicator will disappear if your mains supply is cut. Care should be taken in case the surface temperature is still high.*

Pan sensor

Each zone has a sensor on it, so it can detect the presence of a pan.

- The sensor is fine-tuned to detect a pan being placed on it. The pan should be one size smaller than the nominal diameter of the zone.

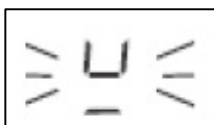

- If after placing a pan on a cooking zone and selecting that cooking zone, a "U" shaped symbol appears on the cooking zone indicator, this means that the pan is either the incorrect size or shape. Or it could be made from a material that is inappropriate for use on an induction zone hob.
- If a cooking zone is selected but no pan is detected, the pan sensor system will check for the presence of a pan

approximately every few seconds. If no pan is detected after 2 minutes the hob will automatically switch off

- You should check that your pans are suitable for use on an induction zone hob (see the pan manufacturer's trademark or instructions).

Cookware that is suitable for an induction hob

The table below shows cookware that is normally suitable for use on an induction zone hob:-

Cookware	Suitable
Steel, enamelled steel	Yes
Cast iron	Yes
Stainless steel	Yes (if stated by the pan manufacturer)
Aluminium, copper, brass	No
Glass, ceramic, porcelain	No

- The bottom of the pans should be as flat and thick as possible.
- Certain types of cookware may result in a noise being made when being used on an induction zone hob. This does not mean that there is an appliance fault.
- **IMPORTANT:** You should make sure that all pans are placed in the centre of the induction zone that you are using.

The boost function

To obtain a faster and more powerful heating speed, the booster function can be used for any cooking zone.

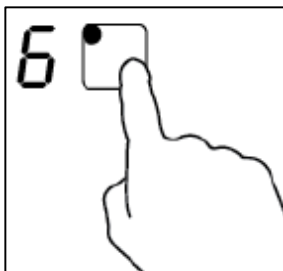

- Press the cooking zone selection button of the zone you wish to use.

- Then press the booster button. The relevant cooking zone indicator will show "b" to indicate that the function has been activated.

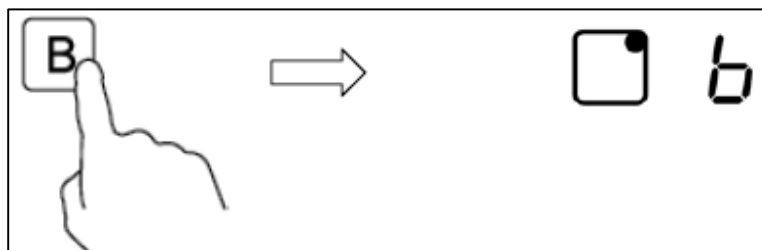

- The boost function will operate the chosen cooking zone at maximum power for 5 minutes. After this time, the cooking zone will return to its original power setting.
- The booster function can be used on every cooking zone.

The hob timer (minute minder)

Your hob has a timer which will countdown a period of time between 1 and 99 minutes. At the end of the countdown period an audible signal will sound.

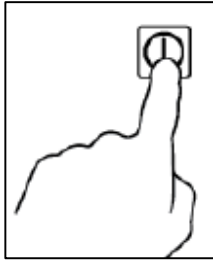

- Press the ON/OFF button to turn the hob on. You can use the minute minder even if you are not selecting a cooking zone.

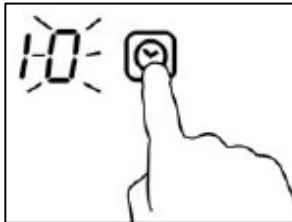

- Press the timer button to enter the minute minder setting mode. The timer indicator will show the default countdown time of "10" minutes and the "0" digit will flash.

- Set the required countdown time (minutes) using the slider control. As you slide the control to the right the time will increase in 1 minute intervals. As you slide the control to the left the time will decrease in 1 minute intervals.

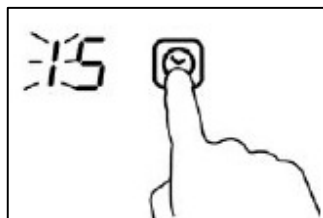
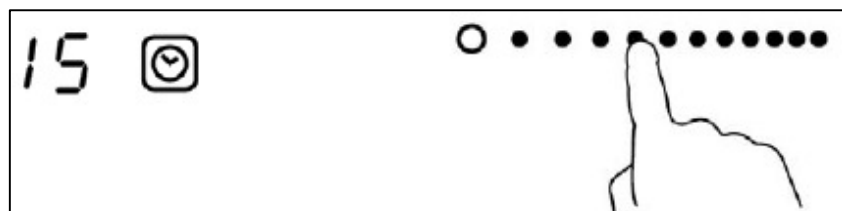

- Press the timer button again and the "1" digit will flash.

- Set the required countdown time using the slider control. As you slide the control to the right the time will increase in 10 minutes intervals. As you slide the control to the left the time will decrease in 10 minute intervals.

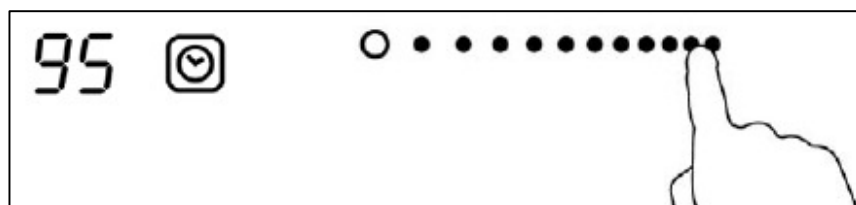

- When the required countdown time is shown in the display, release all controls. The display will show the remaining time before the countdown begins automatically.

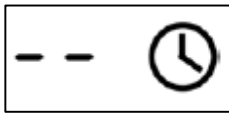

- When the set countdown time has elapsed an alarm will sound for 30 seconds and the timer indicator will show "--".

The hob timer (linked to a cooking zone)

You are able to link a countdown time to a cooking zone so that when the countdown time has elapsed the cooking zone will switch off automatically.

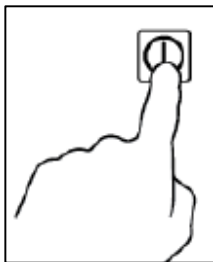

- Press the ON/OFF button to turn the hob on.

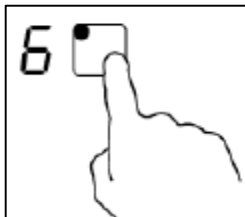

- Press the cooking zone selection button of the cooking zone that you want to use and place a suitable pan on the selected cooking zone.

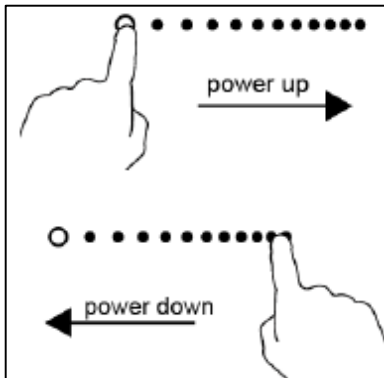

- Select the power level for the cooking zone that you have selected, using the slider control.

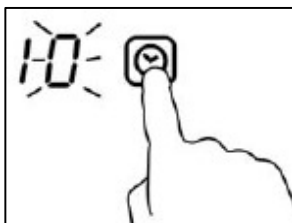

- Press the timer button to enter the countdown setting mode. The timer indicator will show the default countdown time of "10" minutes and the "0" digit will flash.

- Set the required countdown time (minutes) using the slider control. As you slide the control to the right the time will increase in 1 minute intervals. As you slide the control to the left the time will decrease in 1 minute intervals.

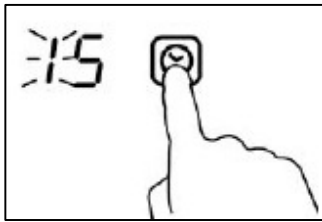
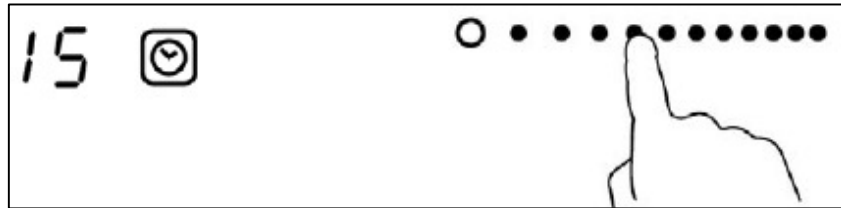

- Press the timer button again and the "1" digit will flash.

- Set the required countdown time using the slider control. As you slide the control to the right the time will increase in 10 minutes intervals. As you slide the control to the left the time will decrease in 10 minute intervals.

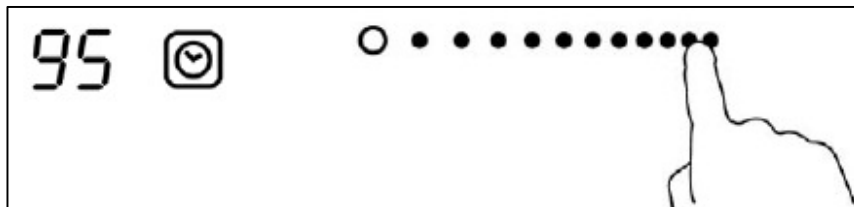

- When the required countdown time is shown in the display, release all controls. The display will show the remaining time before the countdown begins automatically.

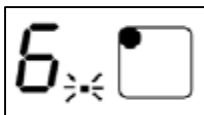

- A red dot will appear next to the power level indicator of the relevant zone. When you set a countdown time for several zones simultaneously, a red dot will appear in all the relevant zone indicators. The timer display will show the minimum countdown and the corresponding red dot will flash.

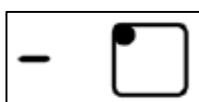
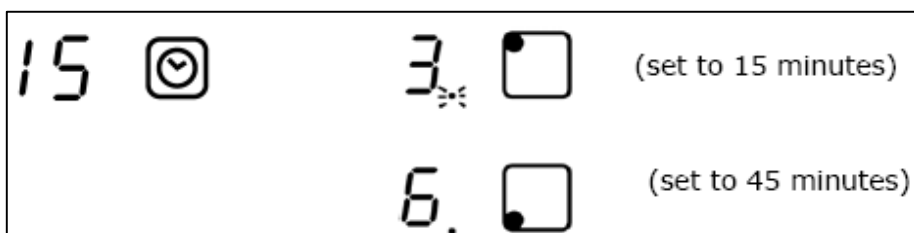

- When the set countdown time has elapsed, the relevant cooking zone will switch off automatically. If countdown timers for other cooking zones are set, the timer display will then show the new minimum countdown and the corresponding red dot will flash.



WARNING: If any other cooking zones are in use, without a countdown timer set, they will continue heating. You will need to switch them off manually when cooking is complete.

labelling Cancelling a timer function



- Press the cooking zone selection button of the zone that you wish to cancel the countdown timer for.



- Press the timer button and the indicator will flash.

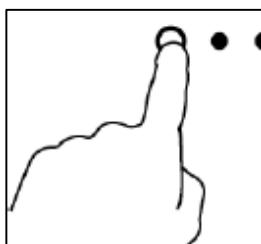

- Slide the slider control to the left to decrease the time until it reaches "00". The timer for that zone will then be cancelled.

labelling Locking the hob top

It is possible to lock the controls to prevent unauthorised usage of the controls by other persons such as children.



- The whole hob top can be locked by pressing the safety lock button whilst the appliance is switched on.
- The timer display will show "L0" to indicate that the safety lock feature has been switched on.
- When the safety lock feature is activated, it will disable all buttons on the control panel **apart** from the ON/OFF button.
- To disable the safety lock feature, you should press and hold the safety lock button for a few seconds. The "L0" symbol will disappear from the timer display and you are then able to use the hob in normal operation.

- If the hob is switched off using the ON/OFF button while the safety lock is activated, the safety lock will still be activated when the hob is turned back on.

Safety cut-off

- If one or more of the cooking zones are accidentally left on, a safety cut off will activate after a certain period of time. The length of time depends on the power level that a zone or zones have been set on.

LEVEL	TIME LIMIT (hours)
1 – 3	8
4 – 6	4
7 – 9	2

- If more than one zone is operating when one of the zones reaches its safety cut-off point, only the zone which has reached its safety cut off point will switch off.

High temperature protection

- The hob is equipped with a temperature sensor which monitors the temperature inside of the appliance.
- If an unusually high temperature is detected the induction hob will stop operating automatically.

Hob guidelines

- The first few times the hob top is used, it may give off an acrid, burning smell. This smell will disappear completely with repeated use.
- The worktop is fitted with cooking areas of different diameter and power.
- The positions where the heat will radiate from are clearly marked on the hob top. The saucepans must be positioned exactly on these zones for efficient heating to occur. Pans should have the same diameter as the cooking zone that they are being used on.
- You should not use saucepans with rough bottoms, as this can scratch the ceramic surface.
- Before use, make sure that the bottoms of the saucepans are clean and dry.

- When cold, the bottom of the pans should be slightly concave, as they expand when hot and lie flat on the surface of the hob. This will allow the heat to transfer more easily.
- The best thickness for the bottom of the pans is 2 – 3 mm of enamelled steel and 4 – 6 mm for stainless steel with sandwich type bottoms.
- If these rules are not followed, then there will be a great loss of heat and energy. Heat not absorbed by the saucepan, will spread to the hob, frame and surrounding cabinets.
- Preferably cover pans with a lid to permit cooking at a lower heat.
- Always cook vegetables and potatoes, etc. in as little water as possible to reduce cooking times.
- Food or liquid that has high sugar content may damage the hob top if it comes into contact with the ceramic hob surface. Any spillages should be wiped up immediately, however this may not prevent the hob surface from becoming damaged.
- **IMPORTANT:** *The ceramic hob surface is tough; however it is not unbreakable and can be damaged. Especially if pointed or hard objects are allowed to fall on it with some force.*
- **DO NOT USE THE HOB IF THE SURFACE BECOMES BROKEN OR CRACKED. YOU SHOULD CONTACT THE BAUMATIC CUSTOMER CARE DEPARTMENT IMMEDIATELY.**

Cleaning and maintenance



Cleaning operations must only be carried out when the hob is cool.

The appliance should be disconnected from your mains supply before commencing any cleaning process.

Cleaning the ceramic hob top



Any residues that are left on the hob top surface from cleaning agents **will** damage it. You should remove any residues with warm water and a little washing up liquid.



Abrasive cleaners or sharp objects will damage the hob surface; you should clean it using warm water and a little washing up liquid.



Although it is easier to clean some deposits whilst the hob surface is still warm. You should take care not to burn yourself if cleaning the hob surface when it is still warm.

After each use

- Wipe the appliance over with a damp cloth and a little washing up liquid.
- Dry the appliance by rubbing the surface with a clean cloth.

Cleaning table

Type of deposit	Remove immediately?	Remove when the appliance has cooled down?	What should I use to remove the deposit?
Sugar or food/liquid containing sugar	Yes	No	Ceramic hob scraper
Tin foil or plastic	Yes	No	Ceramic hob scraper
Fat splashes	No	Yes	Ceramic hob cleaner
Metallic discolourations	No	Yes	Ceramic hob cleaner
Water splashes or water rings	No	Yes	Ceramic hob cleaner

Using a ceramic hob scraper

A ceramic hob scraper will be provided with your appliance. The following guidelines should be followed when using the ceramic hob scraper:-

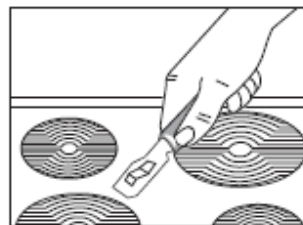

- The scraper should be placed on the ceramic surface at an angle.
- Residues should be removed by sliding the blade carefully over the ceramic surface.

- The ceramic surface should be wiped with a damp cloth and a small amount of washing up liquid.
- Dry the appliance by rubbing the surface with a clean cloth.

Using a specialist ceramic hob cleaner

It is possible to purchase specialist ceramic hob cleaner/conditioner.

You should follow the instructions given by the manufacturer of the specialist ceramic hob cleaner. You should ensure that it is suitable for use on your appliance.

Installation



The installation must be carried out by a suitably qualified person, in accordance with the current version of the following.

- ***UK Regulations and Safety Standards or their European Norm Replacements.***
- ***Building Regulations*** (issued by the Department of the Environment).
- ***Building Standards*** (issued by the Scottish Development Department).
- ***IEE Wiring Regulations.***
- ***Electricity At Work Regulations.***

Positioning



The adjacent furniture must be able to withstand a minimum temperature rise of 85°C above the ambient temperature of the room it is located in, during periods of use.

This appliance is classified as Class 3 and therefore is to be built into a kitchen unit (depending on size) or 600 mm worktop that is at least 30 mm thick. The following minimum clearance distances must be observed:-

- 700 mm between the hob surface and the underside of any horizontal surface above it.
- 50 mm clearance around the sides and front of the appliance, measured from the cut out.
- 55 mm clearance between the back of the hob surface and the wall behind it, measured from the cut out.

- If the hob is positioned so that the right or left hand side of the appliance will be near to the edge of a kitchen unit. There must be a gap of at least 150 mm between the side of the hob and the vertical surface of the kitchen unit.

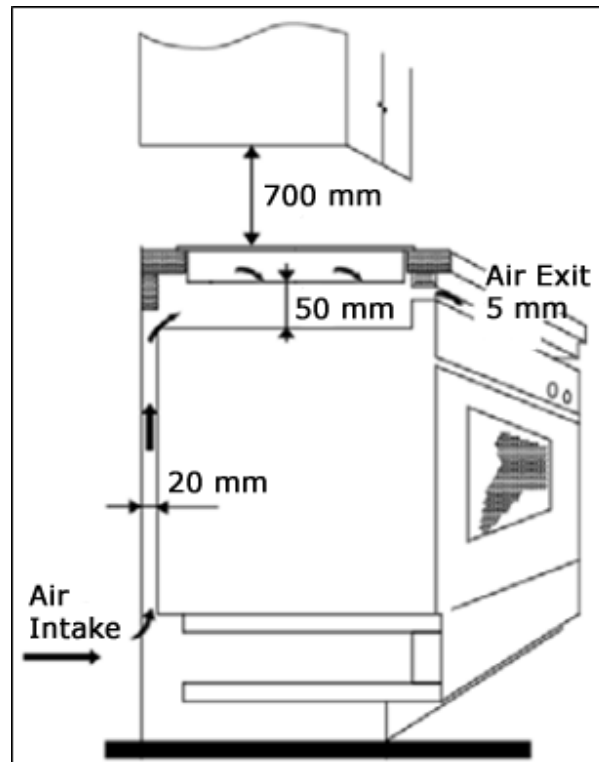

- **IMPORTANT:** *Underneath the appliance there must be a partition made of insulating material (e.g. wood). There must be a gap of at least 50 mm between the underneath of the appliance and this partition.*
- You must make sure that there is a 5mm gap below the underneath of the worktop at the front edge of the hob.

Unpacking the appliance

When unpacking the appliance please check that the following items are contained within the packaging:-

- 1 Baumatic hob
- 1 Ceramic hob scraper
- 1 Installation and instruction manual
- 1 Baumatic guarantee card
- Fixing brackets
- Fixing screws

Installing the appliance

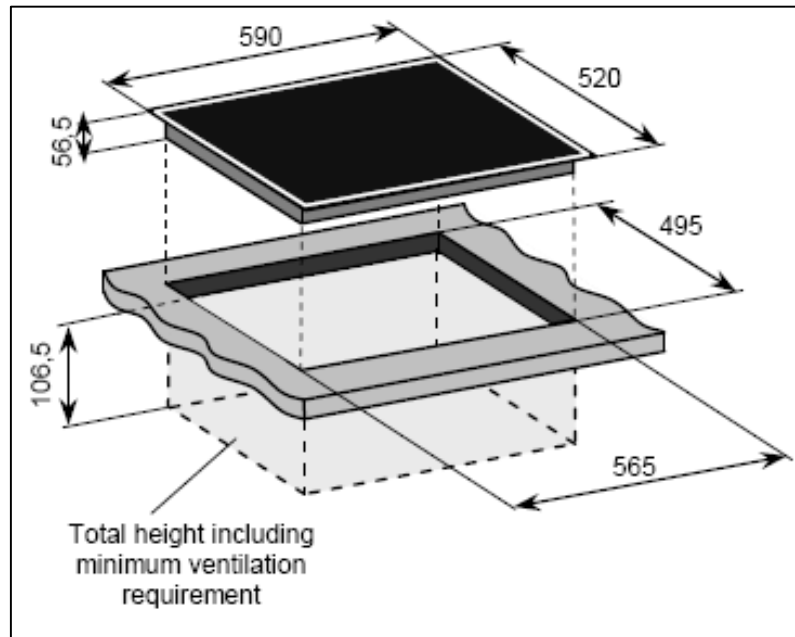

- Cut a hole in the worktop that corresponds with the drawing shown above.

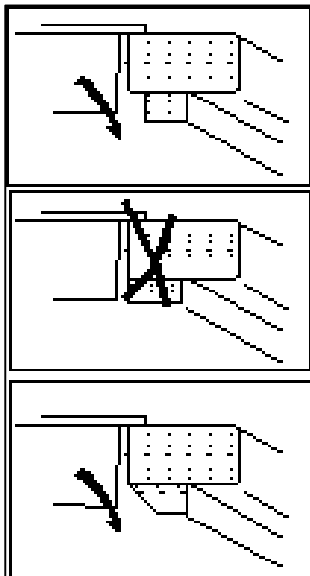

- **IMPORTANT:** There are ventilation holes around the outside of the hob. **YOU MUST** ensure that these holes are not blocked by the work top, when you put the hob into position (see drawing opposite).

- **IMPORTANT:** Do not use a silicon sealant to seal the appliance against the aperture. This will make it difficult to remove the hob from the aperture in future, particularly if it needs to be serviced.

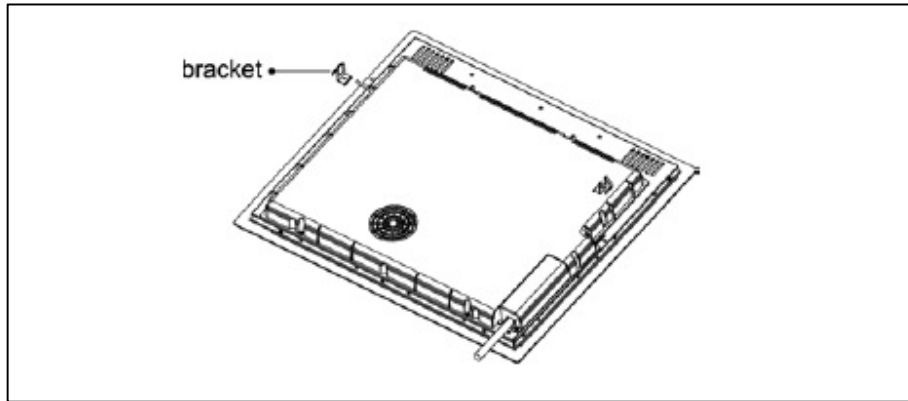

- Carefully lower the hob into the aperture hole that you have cut out.
- There are holes on the base of the hob that you can fix the brackets to.



You should place the bracket on the underneath of the hob, in a position that is appropriate for the aperture that you have cut out. Using the screws provided, fix the bracket to the hob. These screws **MUST** be securely tightened.

Electrical connection



This appliance must be installed by a qualified person in accordance with the latest edition of the I.E.E. Regulations and in compliance with Baumatic's instructions.

Before connecting the appliance, make sure that the supply voltage marked on the rating plate corresponds with your mains supply voltage.

WARNING: THIS APPLIANCE MUST BE EARTHED.

- This appliance must be wired into a 30 A double pole switched fused spur outlet, having 3 mm contact separation and placed in an easily accessible position adjacent to the appliance. It should not be located above the appliance and no more than 1.25m away from it.

- The spur outlet must still be accessible even when your hob is located in its operating position.
- Cable type: H05 RRF 3 core x 6 mm² (not supplied).

Connecting the mains supply cable

- The mains terminal block is located on the underside of the hob and the terminals are accessible by removing the terminal block cover by removing the cover screw.

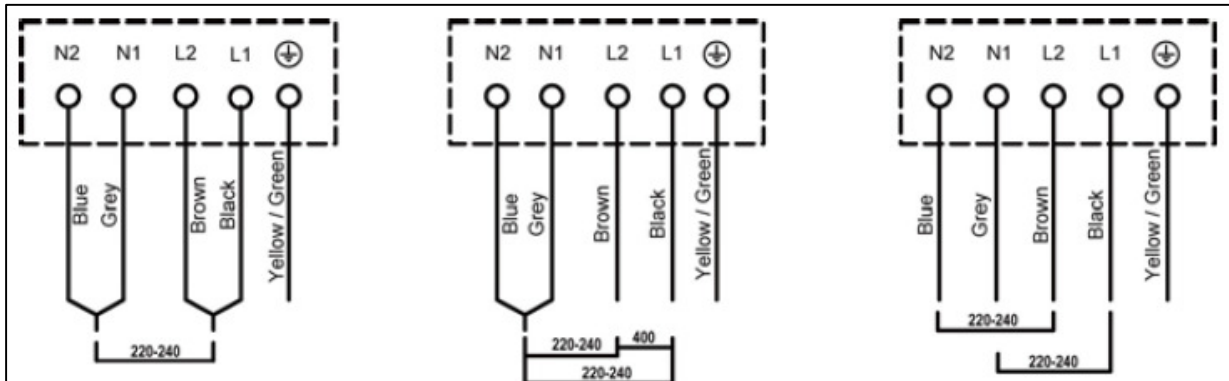

- The brass links must be positioned as marked in the appropriate diagram and once established ALL terminal screws must be tightened down firmly.
- ***If when the hob is first switched on, only two of the zones work, you should recheck that the terminal screws are all fully tightened between the links. This should be done before contacting the Baumatic Customer Care Department.***
- ***IMPORTANT:*** The appliance must NOT be connected to the mains supply by means of a 13A plug and socket.
- The cable can be looped if necessary, but make sure that is not kinked or trapped when the hob is in position. Care must be taken to avoid the cable being in contact with hot parts of the appliance.

Replacing the mains supply cable

If the mains supply cable is damaged, then it must be replaced by an appropriate replacement.

The mains supply cable should be replaced in accordance with the instructions below:

- **Switch the appliance off at the socket.**
- Open the terminal block on the underside of the hob.
- Unscrew the terminal screws fixing the cable.
- Replace the cable with one of the same length and in accordance with the specification given on page 28.
- The “green-yellow” earth wire must be connected to the terminal marked \perp . It must be about 10 mm longer than the live and neutral wires.
- The “blue” neutral wire must be connected to the terminal marked with letter (N) - the live wire must be connected to the terminal marked with letter (L).

My appliance isn't working correctly

- **The cooking zones are not functioning or will not switch on.**
- * The safety lock has been switched on (see the “Locking the hob top” section for information on how to turn off the safety lock).
- * Several cooking zone selection buttons have been pressed at once. You should only touch one cooking zone selection button at once.
- * The safety cut out has been triggered. Press a cooking zone selection button to reset the hob.
- * Check that the mains electrical supply to the appliance is correct and working. Check the mains fuse.
- * The pans that you are using are not suitable for use on an induction hob.

- **The residual heat indicator has not come on after I have switched a cooking zone off.**
- * The cooking zone has only been turned on for a short period of time; therefore it did not go above 60°C.
- * **IMPORTANT:** *If the cooking zone does appear to be hotter than 60°C and the residual heat indicator has not come on, you should call the Baumatic Customer Care Department.*
- **A humming sound is heard when a cooking zone is selected.**
- * This is normal; the sound will disappear when the zone heats up.
- **The cooking zones have become discoloured.**
- * This maybe caused by burnt on remnants of food. This will not affect the working of the appliance. However you should make sure that the cleaning instructions are being followed regularly.
- **Only two of the zones on my hob are working**
- * You should recheck that the terminal screws are all fully tightened between the links.

Error codes

The following error codes may appear in the timer display if there is a problem with the operation of the hob.

Error code	Likely cause	Possible solution
F3-F8	Thermo component failure.	Turn the power off and restart when the temperature returns to normal.
F9-FE	Temperature sensor of IGBT failure.	Turn the power off and restart when the temperature returns to normal.
E1-E2	Abnormal supply voltage.	Check the power supply to the appliance is correct.
E3-E4	Abnormal temperature.	Check the pot being used is suitable. Turn the power off and restart when the cooking zone cools down.
E5-E6	Bad cooking zone heat radiation.	Turn the power off and restart when the cooking zone cools down.

IMPORTANT: *If any other error codes appear on the cooking zone display, you should turn the appliance off at the mains*

and contact the Customer Care Helpline. DO NOT continue to use the appliance.



IMPORTANT: If your appliance appears not to be operating correctly, then you should disconnect it from your mains supply and then contact Baumatic Customer Care on telephone number (0118) 933 6911.

DO NOT ATTEMPT TO REPAIR THE APPLIANCE YOURSELF.

Please note that if an engineer is asked to attend whilst the product is under guarantee and finds that the problem is not the result of an appliance fault, then you may be liable for the cost of the call out charge.

The appliance must be accessible for the engineer to perform any necessary repair. If your appliance is installed in such a way that an engineer is concerned that damage will be caused to the appliance or your kitchen, then he will not complete a repair.

This includes situations where appliances have been tiled in, sealed in with sealant, have wooden obstructions placed in front of the appliance, like plinths. Or any installation other than the one specified by Baumatic Ltd. has been completed.

Please refer to the conditions of guarantee that appear on the warranty card that you receive with the appliance.

IMPORTANT: Baumatic Ltd. operates a policy of continuous improvement and reserves the right to adjust and modify its products without prior notification.

Baumatic Consumables

- **BC001** Degreaser for Dishwashers (200 g)
- **BC002** Descaler for Washing Machines and Dishwashers (200 g)
- **BC003** Ceramic Hob Cleaner (250 ml)
- **BC004** Oven Cleaner (250 ml)
- **BC005** Stainless Steel Cleaner and Protector (250 ml)
- **BC007** E-Cloth – General Purpose Cloth
- **BC008** Microwave Cover

To order a Baumatic consumable product please call 0123 5437 244 and quote the product code. You can also order online from eshop.baumatic.co.uk



United Kingdom

Baumatic Ltd.,
Baumatic Buildings,
6 Bennet Road,
Reading, Berkshire
RG2 0QX
United Kingdom

Sales Telephone

(0118) 933 6900

Sales Fax

(0118) 931 0035

Customer Care Telephone

(0118) 933 6911

Customer Care Fax

(0118) 986 9124

Spares Telephone

(01235) 437244

Advice Line Telephone

(0118) 933 6933

E-mail:

sales@baumatic.co.uk
customercare@baumatic.co.uk
spares@baumatic.co.uk
technical@baumatic.co.uk

Website:

www.baumatic.co.uk

Facebook:

www.facebook.com/baumatic.uk

Republic of Ireland

Service Telephone

1-890 812 724

Spares Telephone

091 756 771

Czech Republic

Baumatic CR spol s.r.o.
Lípová 665
460 01 Liberec 4
Czech Republic

+420 483 577 200

www.baumatic.cz

Slovakia

Baumatic Slovakia, s.r.o.
Panenskà 34
811 03 Bratislava – Staré Mesto
Slovakia

+421 255 640 618

www.baumatic.sk

Germany

Baumatic Gmbh
Bachstr.10-12
D-32257 Bünde
Deutschland

+49 (0) 5223 99408 0

www.baumatic.de

Italy

Baumatic Italia S.R.L.
Via Galvani N.3
35011 Campodarsego (PD)

+3904 9920 2297

www.baumatic.it

Holland

Baumatic Benelux B.V.
Dukdalfweg 15d
1332 BH ALMERE
Nederland

+31(0)36 549 1553

www.baumatic.nl

