

Instruction manual

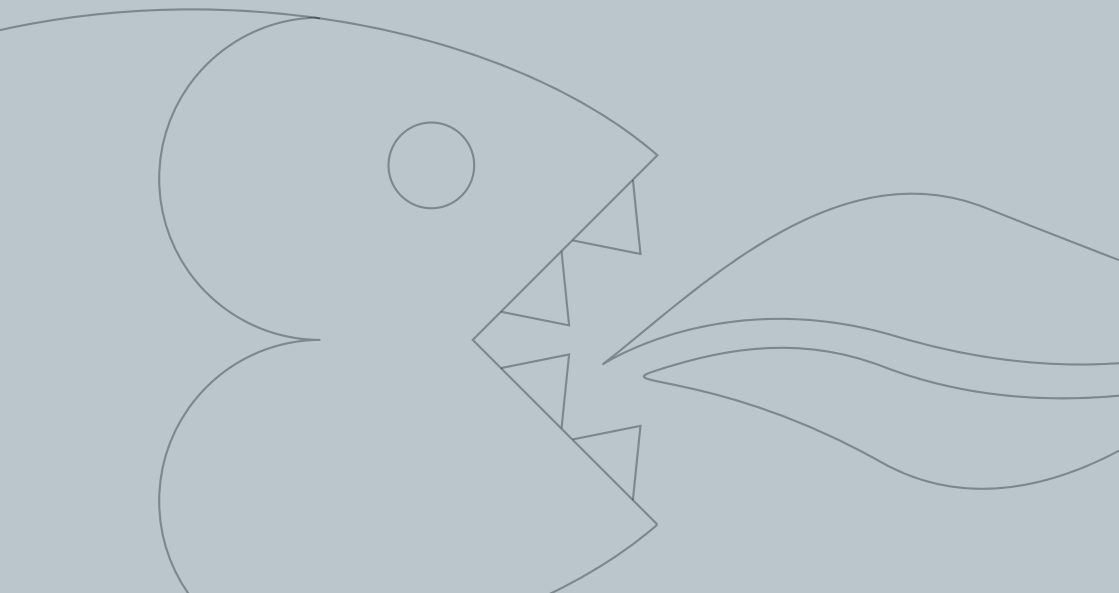
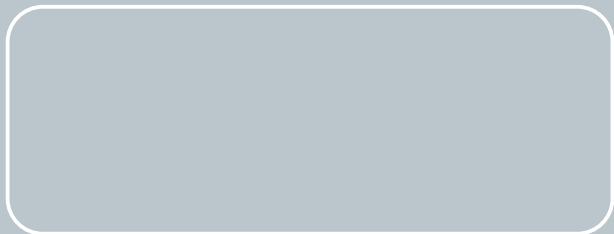

GAS HOBS

USER AND INSTALLATION INSTRUCTIONS

For future reference please record the following information which can be found on the Rating Plate and the date of purchase which can be found in the invoice:

Model Number

Serial Number

Date of Purchase

CONTENTS

General Information	page 4
Warning and Safety Instructions	page 5
Instructions for Use	pages 6–7
Instructions for Installation	Pages 8–12
Technical Data	Pages 12–14
Conditions of Guarantee	Back cover

GENERAL INFORMATION

Please read this booklet thoroughly before you use this appliance. It is important that you understand all the control functions before commencing to cook with your Baumatic appliance.

Please remember the advice and warnings shown on page 5, which is headed 'IMPORTANT – Warning and Safety Instructions'.

This appliance is designed for domestic household use when built into a kitchen worktop. NOTE: The housing, adjacent furniture and all materials used in the installation must be able to withstand a minimum temperature rise of 85°C above ambient during periods of operation. This information is for guidance only and the actual withstand temperature will depend on the performance rating for the surface finish of the worktop.

Certain types of kitchen furniture surface finishes are particularly prone to heat damage or discolouration at temperatures lower than the above guidelines.

Installing the appliance in contravention of the guidance given, will be at the liability of the owner.

For use in Leisure Accommodation Vehicles, notice must be taken of the appropriate statement in the Installation Instructions (see page 9 – Important Note 5).

The use for any other purpose or in any other environment without the express agreement of Baumatic Ltd, would invalidate any warrantee or liability claim

Your new appliance is guaranteed against electrical or mechanical defects subject to certain exclusions noted in Baumatic Ltd Conditions of Guarantee. The foregoing does not affect your statutory rights.

The Warrantee applies to Great Britain and Northern Ireland only.

In the event that you require any After Sales Service or advice, please contact the Baumatic Service Department on telephone number – 0118 933 6911.

Before using this appliance ensure that any protective packaging or coatings have been removed.

To aid the protection of the environment, please sort the packing materials into different types and dispose of them in accordance with the local waste disposal laws.

Any further information can be obtained from your local Environment Agency office.

When first used, an odour may be emitted by any residual protective finish or moisture, which will cease after a short period of time.

This appliance has been constructed and distributed in compliance with the essential requirements of the following EEC DIRECTIVES and EUROPEAN NORMS :-

CE Marking – 93/68 Low Voltage – 73/23 Gas Products – 90/396 EMC – 89/336 Materials that can touch food – 89/109.

Safety Standards – EN 60 335-1, EN 60 335 – 2 – 6, EN 30-1-1.

As Baumatic have a policy of continued product improvement, the right is reserved to adjust and make any modifications deemed necessary without notification.

IMPORTANT NOTE – WARNING and SAFETY INSTRUCTIONS

This appliance complies with all current European safety legislation, however Baumatic do wish to emphasise that compliance does not remove the fact that surfaces will become hot during use and retain heat after operation.

Baumatic therefore strongly advise that babies and young children are prevented from being near or touching the appliance at any time.

If it is necessary for younger family members to be in the kitchen, that they are kept under close supervision at all times.

We also advise that great care is taken during use and cleaning operations.

Do make sure that the pan handles are always correctly positioned to avoid accidental contact.

Do not leave heated oil or fat unattended as there is a risk of fire.

Do use pans that are flat bottomed and the correct size for the heating area to be used (never smaller).

Do not allow electrical fittings or cables to be in contact with hot areas of the appliance.

Do not use the appliance for space heating or to dry clothes.

Do not install the appliance next to curtains or soft furnishings.

NOTE: This appliance must be correctly installed by a suitably qualified person, strictly in accordance with the manufacturer's instructions. For gas installations, the Installer must be Corgi registered (all Baumatic Engineers are Corgi registered) and for electrical installations, NICEIC registration is recommended.

Baumatic Ltd declines any responsibility for injury or damage to persons or property as a result of improper use or installation of this appliance.

Heat, steam and moisture will be created during use, take care to avoid injury and ensure that the room is adequately ventilated. If prolonged use occurs, additional ventilation may be required – please consult your Qualified Installer if you are in any doubt about the amount required.

USER INSTRUCTIONS

INSTRUCTIONS FOR USE

These User Instructions should be retained for future reference and for use by a person who is perhaps unfamiliar with the appliance.

The following models are covered by these instructions:

B60	B68	B17.5	P68	BC45
B61	B69	B17.6	P75	BF45
B62	B16.5	B17.7	P90	AS24
BT62	B16.6	PG2	PF75	AS25
B64	BG2	PWK1	B44	
B67	BWK1	P62	B46	

USING THE HOB

The symbols on the Control Panel fascias show which burner the Control Knob operates.

Dependent on the model there are two methods for igniting the burners.

1. Auto Ignition

After pressing in and turning the appropriate knob anti-clockwise to the large flame symbol, the ignition spark will operate as long as the knob is pressed down. When a flame has been established the knob can be released.

2. Manual Ignition

After pressing in and turning the appropriate knob anti-clockwise to the large flame symbol, press the ignition button located on the control panel. The ignition spark will operate as long as the button is held down. When a flame has been established, release the button.

To regulate the flame, continue turning anti-clockwise to the required setting between the large and small flame symbols.

To turn the burner off, turn fully clockwise.

NOTE:

When a Thermocouple Safety Device is incorporated in the appliance, it is necessary for the knob to be continuously held down for a further period of approximately 10 seconds after the flame has been established to enable the thermocouple to function.

The Safety Device is designed to stop the flow of gas to the burner head in the event of a flame out situation.

Please note that this appliance carries the **CE** mark for normal domestic use and is not suitable for the marine environment.

USER INSTRUCTIONS

HELPFUL HINTS

Always use the correct diameter pan, one that is the same or slightly larger than the flame ring. The flame should never exceed the diameter of the pan.

For model PF75 please make sure you comply with maximum pans' diameters allowed as showed in the picture:

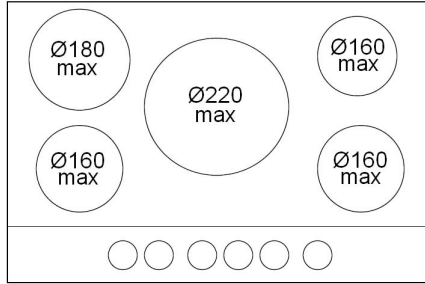

The bottom of the pan should be flat and wherever possible, keep the lid on the pan when cooking.

Depending on the model the following burners are provided:

Large (Rapid or Triple Crown) – for rapid cooking or boiling large quantities of liquid

Wok – for rapid cooking or boiling large quantities of liquid

Medium (Semi-rapid) – for general cooking

Small (Auxiliary)– for slow or simmer cooking

Fish Kettle – for specialised cooking

All burners are variable between full and low positions

WARNING

Do not use commercial simmering aids as these can create excessive heat, which can damage the appliance.

CLEANING THE APPLIANCE

Always allow the appliance to cool down before cleaning to avoid a burn injury.

Do not use caustic or abrasive agents, coarse wire wool or hard tools as these can damage the surface finishes.

Normally, wiping with a soft cloth dampened with hot detergent solution is sufficient but for stubborn marks the following is recommended:

Vitreous Enamel parts – use only a cleaner that is recommended for this type of material.

Burner Assemblies – remove from the hob and soak for about 10 minutes in hot detergent solution. Rinse off and dry checking that the burner holes are not clogged, then reassemble in the correct order.

INSTALLATION INSTRUCTIONS

INSTRUCTIONS FOR INSTALLATION

This appliance must be installed by a competent person in accordance with the current version of the following UK Regulations and Safety Standards or their European Norm Replacements:

NOTE: UK law stipulates that gas appliances must be installed and repaired by a CORGI Registered Installer (all Baumatic Engineers are CORGI Registered).

Gas safety Regulations (Installation & Use)

Building Regulations (issued by the Department of Environment)

Building Standards (Issued by the Scottish Development Department)

IEE Wiring Regulations

Electricity at Work Regulations

BS 6172 Installation of Domestic Gas Cooking Appliances

(if necessary, **BS 5482 Installation of Domestic LPG Appliances**)

BS 5440 Installation of Flues and Ventilation for Gas Appliances

Baumatic Ltd Installation Instructions

POSITIONING THE APPLIANCE

This appliance is classified as Class 3 and therefore is to be built into a kitchen unit (depending on size) or 600mm wide worktop, providing the following minimum distance is allowed:

- 700mm between the top surface and the underside of any horizontal surface above it.
- 50mm clearance around the appliance and combustible materials.

The surface finish of any adjacent unit must be capable of withstanding a minimum temperature of 85°C.

PRE-COMMISSIONING THE APPLIANCE

When unpacked, check that the following parts are included with the appliance:-

- Baumatic Ltd Instruction and Installation Book
- Pan Supports
- Burner Assemblies
- Adhesive sealing strip and fixing clamps & screws
- ½ BSP Elbow & Seal
- LPG conversion kit comprising an LPG jet for each burner and a self-adhesive label for amending Gas Category on the appliance Rating Label.

INSTALLATION INSTRUCTIONS

INSTALLATION NOTES

1. Cut the aperture to the dimensions shown below or use the template if printed on the packaging.
2. Invert the Hob and apply the sealing agent provided to match the outer perimeter edge.
3. If the sealing agent is a strip type, the protective covering must be removed from both sides.

Do not leave a gap in the sealing agent or overlap the thickness.

NOTE: do not use any Silicone based sealant, as this can damage the worktop surface if repairs are required.

4. Insert the appliance into the aperture and fix in position via the clamps & screws, tightening the screws evenly (see Fig. 1 below).
5. If the appliance is to be installed in a Leisure Accommodation Vehicle, the requirements of N 721 must be applied.

HOB APERTURE DIMENSIONS

Model	A	B	C	D	E
B60	595	500	560	480	30
B61	595	500	560	480	30
B62	595	510	560	480	30
BT62	595	510	560	480	30
B67	685	510	560	480	30
B68	685	510	560	480	30
B69	685	510	560	480	30
B16.5	860	510	830	480	30
B16.6	860	510	830	480	30
BG2	288	510	490	268	30
BWK1	288	510	490	268	30
B17.5	860	510	830	480	30
B17.6	860	510	830	480	30
B17.7	860	510	830	480	30
PG2	288	510	285	480	30
PWK1	288	510	490	268	30
P62	585	500	560	480	30
P68	685	500	560	480	30
P75	740	500	560	480	30
P90	860	510	830	480	30
PF75	740	500	700	480	30
B44	600	510	560	480	30
B46	600	510	560	480	30
BC45	600	510	560	480	30
BF45	600	510	560	480	30
AS24	595	510	560	480	30
AS25	740	510	560	480	30

Fig.1

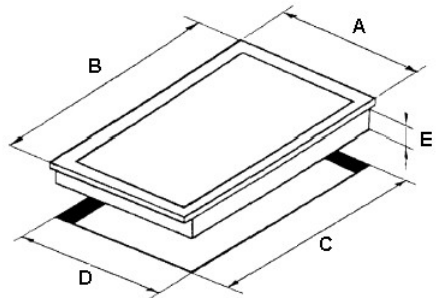
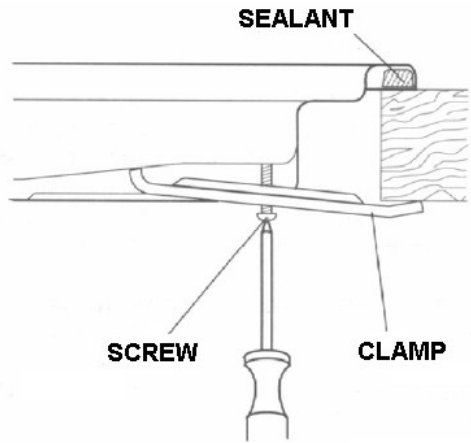

INSTALLATION INSTRUCTIONS

VENTILATION OF ROOMS

The actual ventilation requirements must be determined by reference to the Statutory Regulations in force.

GAS CONNECTION

With one exception these appliances must be connected to the gas supply by use of the ½ BSP Elbow, seal and copper pipe and an isolation tap fitted in an easily accessible position.

The one exception to the above is for the BT62 Hob unit when installed into the CK5 Cooking centre for which connection to the gas supply must be made via a flexible hose in compliance of BS6172.

This appliance as supplied is for use with Natural Gas, if it is to be adapted for LPG proceed as follows:

1. Isolate the appliance from the electricity and gas supplies.
2. Remove the pan supports and burner assemblies.
3. Replace the injectors with the alternative LPG injectors, supplied.
4. Use the appropriate thread sealant and check for gas soundness.
5. Affix the self-adhesive label to the rating plate to amend the Gas Category details.

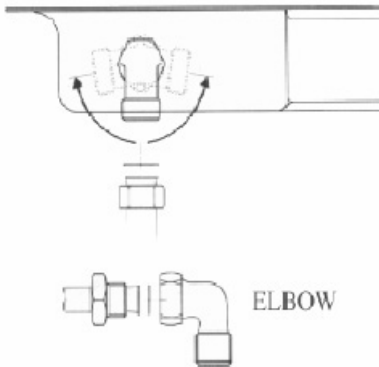

Fig. 2



Fig. 3

In order to adjust the minimum gas flow proceed as follows:

- Ignite the burner and turn down to the minimum setting.
- Remove the control Knob from the gas tap.
- Adjust the flow either clockwise to decrease or anti-clockwise to increase the flame. Use a screwdriver inserted down the gas tap rod or via the screw head adjacent to the rod for models fitted with a Flame Supervision Device.
- Check that the flame is 3-4 mm in length, bluish in colour, stable and noiseless, and does not extinguish when changing from maximum to minimum flow.
- Replace the control knob and check that all components have been reassembled correctly.

INSTALLATION INSTRUCTIONS

ELECTRICAL CONNECTION

Before connecting the appliance, make sure the supply voltage marked on the rating Plate corresponds with the mains supply voltage.

WARNING – THIS APPLIANCE MUST BE EARTHED

This appliance should be wired into a double pole Switched Fused Spur Outlet having 3 mm contact separation and the fuse rating reduced to 3 Amps.

IMPORTANT

The wires in the main supply lead are coloured in accordance with the following code:-

Green and Yellow – Earth

Blue – Neutral

Brown – Live

The connections must be made as follows:-

The wire coloured Green and Yellow must be connected to the terminal marked ‘E’ or the earth symbol (.) or coloured green and yellow.

The wire coloured Blue must be connected to the terminal marked ‘N’ or coloured blue or Black.

The wire coloured Brown must be connected to the terminal marked ‘L’ or coloured brown or red.

NOTE: The terminals marked ‘SUPPLY’ are for the mains supply wires and the terminations marked ‘LOAD’ are for the appliance wires.

The electrical outlet is to be positioned in an easily accessible position adjacent to the appliance.

In the event that it is necessary to replace the mains supply lead, the replacement must conform to the specification listed in the Technical Data. Ensure that the colour code connection is correct and that all screws are tightened correctly.

INSTALLATION INSTRUCTIONS

MAINTENANCE

During the guarantee period, in case of need all service intervention should be referred back to the Baumatic Ltd Service department. Please note that intervention or repair by any unauthorised personnel will invalidate such guarantee.

Before carrying out any maintenance, disconnect the appliance from the gas and electricity supplies.

If a gas tap becomes stiff to operate, proceed as follows:

- Remove the control knobs, pan supports, burners and hob fixing screws & clamps.
- Remove the Hob from the worktop and remove any underside protective covers.
- Disconnect the fixings holding the tap to the fascia panel, separate the assembly, then clean the cone and seating with a cloth dampened with solvent.
- Lightly smear the cone with high temperature grease, reassemble into position and rotate a few times. Remove the cone again and remove any excess grease making sure that the gas ducts are not obstructed with grease.
- Carefully reassemble the components and check for gas soundness.

If it becomes necessary to replace the gas tap, proceed as follows:

- Disconnect the appliance as described above.
- Disconnect the gas pipe from the gas tap, disassemble from the gas rail by removing the fixing screws.
- When fitting a new tap, ensure that a new gasket is used.
- Re-connect the gas tap, check for gas soundness and reassemble the hob.

TECHNICAL DATA

ELECTRICAL DETAILS

Rated Voltage	230V ac 50Hz
Supply Connection	13A (double pole switched fused outlet with 3mm contact gap)
Power Input	0.008 to 0.02kW (depending on model)
Mains supply lead	3 x 0.75mm ² Type RR-F <HAR> marked

GAS DETAILS

Connection	Rp ½ (ISO R7)
Type	Natural Gas (20.9 mbar) – alternative LPG G30 (28-30 mbar) [Town Gas G110 – 120 (8 mbar) to order]

BURNER TYPES AND POWER INPUTS : kW

Model	Large Max/Min	Medium Max/Min	Small Max/Min	Wok Max/Min	Fish Max/Min	Total Max
B60	3.0/0.75	1.75/0.44	1.0/0.3	-	-	7.50
B61	-	1.75/0.44	1.0/0.3	3.3/1.5	-	7.80
B62	-	1.75/0.44	1.0/0.3	3.3/1.5	-	7.80
BT62	-	1.75/0.44	1.0/0.3	3.3/1.5	-	7.80
B67	3.0/0.75	1.75/0.44	1.0/0.3	3.3/1.5	-	10.80
B68	3.0/0.75	1.75/0.44	1.0/0.3	3.3/1.5	-	10.80
B69	3.0/0.75	1.75/0.44	1.0/0.3	3.3/1.5	-	10.80
B16.5	3.0/0.75	1.75/0.44	1.0/0.3	3.3/1.5	-	10.80
B16.6	3.0/0.75	1.75/0.44	1.0/0.3	-	-	12.25
BG2	3.0/0.75	-	1.0/0.3	-	-	4.00
BWK1	-	-	-	3.3/1.5	-	3.30
B17.5	3.0/0.75	1.75/0.44	1.0/0.3	3.3/1.5	-	10.80
B17.6	3.0/0.75	1.75/0.44	1.0/0.3	-	-	12.25
B17.7	-	1.75/0.44	1.0/0.3	3.3/1.5	2.9/1.5	10.70
PG2	3.0/0.75	-	1.0/0.3	-	-	4.00
PWK1	-	-	-	4.2/0.3	-	4.20
P62	-	1.75/0.44	1.0/0.3	3.3/1.5	-	7.80
P68	3.0/0.75	1.75/0.44	1.0/0.3	3.8/1.5	-	11.30
P75	3.0/0.75	1.75/0.44	1.0/0.3	4.2/0.3	-	11.70
P90	3.0/0.75	1.75/0.44	1.0/0.3	4.2/0.3	-	11.70
PF75	-	1.75/0.44	1.0/0.3	4.2/0.3	-	9.70
B44	3.0/0.75	1.75/0.44	1.0/0.3	-	-	7.50
BC45	3.0/0.75	1.75/0.44	1.0/0.3	-	-	7.50
BF45	3.0/0.75	1.75/0.44	1.0/0.3	-	-	7.50
B46	3.0/0.75	1.75/0.44	1.0/0.3	-	-	7.50
AS24	3.0/0.75	1.75/0.44	1.0/0.3	-	-	7.50
AS25	3.0/0.75	1.75/0.44	1.0/0.3	3.8/1.5	-	11.30

JET SIZING CONVERSION TABLE: NATURAL GAS / LPG

Model	Large NG/LPG	Medium NG/LPG	Small NG/LPG	Wok NG/LPG	Fish NG/LPG
B60	1.15/0.85	0.97/0.65	0.72/0.50	-	-
B61	-	0.97/0.65	0.72/0.50	1.24/0.91	-
B62	-	0.97/0.65	0.72/0.50	1.24/0.91	-
BT62	-	0.97/0.65	0.72/0.50	1.24/0.91	-
B67	1.15/0.85	0.97/0.65	0.72/0.50	1.24/0.91	-
B68	1.15/0.85	0.97/0.65	0.72/0.50	1.24/0.91	-
B69	1.15/0.85	0.97/0.65	0.72/0.50	1.24/0.91	-
B16.5	1.15/0.85	0.97/0.65	0.72/0.50	1.24/0.91	-
B16.6	1.15/0.85	0.97/0.65	0.72/0.50	-	-
BG2	1.15/0.85	-	0.72/0.50	-	-
BWK1	-	-	-	1.24/0.91	-
B17.5	1.15/0.85	0.97/0.65	0.72/0.50	1.24/0.91	-
B17.6	1.15/0.85	0.97/0.65	0.72/0.50	1.24/0.91	-
B17.7	-	0.97/0.65	0.72/0.50	1.24/0.91	1.2/0.85
PG2	1.15/0.85	-	0.72/0.50	-	-
PWK1	-	-	-	0.72-0.95/0.46-0.66	-
P62	-	0.97/0.65	0.72/0.50	1.24/0.91	-
P68	1.15/0.85	0.97/0.65	0.72/0.50	1.35 / 0.98	-
P75	1.15/0.85	0.97/0.65	0.72/0.50	0.72-0.95/0.46-0.66	-
P90	1.15/0.85	0.97/0.65	0.72/0.50	0.72-0.95/0.46-0.66	-
PF75	-	0.97/0.65	0.72/0.50	0.72-0.95/0.46-0.66	-
B44	1.15/0.85	0.97/0.65	0.72/0.50	-	-
BC45	1.15/0.85	0.97/0.65	0.72/0.50	-	-
BF45	1.15/0.85	0.97/0.65	0.72/0.50	-	-
B46	1.15/0.85	0.97/0.65	0.72/0.50	-	-
AS24	1.15/0.85	0.97/0.65	0.72/0.50	-	-
AS25	1.15/0.85	0.97/0.65	0.72/0.50	1.35/0.98	-

BAUMATIC Ltd
CONDITIONS OF GUARANTEE

Dear Customer,

Included with your new Baumatic appliance is a guarantee registration card, please complete this and return at your earliest convenience.

This guarantee is in addition to your statutory legal rights and will not in any way hinder any legal rights.

The conditions of the guarantee, which applies, to your Baumatic appliance are as follows:

All 'Work' in relation to the Guarantee must be carried out by Baumatic Ltd or an approved service agent of Baumatic Ltd. Any claims made under the terms of the guarantee must be supported by the original invoice / bill of sale issued at the time of purchase.

The guarantee period starts from the date of the original purchase and the manufacturer will provide the parts and labour required to repair the appliance should breakdown occur as a result of mechanical / electrical failure. This service will be given Free of charge within the Guarantee period. An additional Insurance scheme is available should you wish to extend the warranty period.

This guarantee applies to UK mainland and Northern Ireland only.

THIS GUARANTEE DOES NOT COVER:

- Any damage caused by transit, misuse, or neglect.
- Cosmetic and perishable parts: plugs, fuses, light bulbs, light covers, cosmetic trims, cables, filters and attachments, knobs, any rubber and seals, ceramic or glass surfaces, dents, scratches, paintwork.
- Attachments / Accessories, trivets and handles, griddles, pan stands, shelves, burner caps and collars, oven liners. Plus any additions thereafter.
- Periodic maintenance, the repair or replacement of parts due to natural wear and tear.
- Material discoloration, corrosion.
- Incorrect installations, modifications or repair by any unauthorised personnel.
- Use of non-Baumatic parts.
- Damage caused by foreign objects or substances.
- Appliances used for non-domestic use.
- Operation on unsuitable voltage, water or gas supplies.
- Accidents, Civil war, acts of God or any cause beyond the control of Baumatic Ltd.

PLEASE NOTE ALL GUARANTEES ARE NON TRANSFERABLE

SALES	SERVICE	SPARES
TEL 0118 933 6900	TEL 0118 933 6911	TEL 0118 933 6922
FAX 0118 931 0035	TEL 0118 986 9124	

For further information or any other query you may have please contact one of the above numbers.

Thank you for buying Baumatic.

D In Übereinstimmung mit den Anforderungen der Europäischen Richtlinie 2002/96/EG über Elektro- und Elektronik-Altgeräte (WEEE) ist vorliegendes Gerät mit einer Markierung versehen. Sie leisten einen positiven Beitrag für den Schutz der Umwelt und die Gesundheit des Menschen, wenn Sie dieses Gerät einer gesonderten Abfallsammlung zuführen. Im unsortierten Siedlungsmüll könnte ein solches Gerät durch unsachgemäße Entsorgung negative Konsequenzen nach sich ziehen. Auf dem Produkt oder der beiliegenden Produktdokumentation ist

folgendes Symbol  einer durchgestrichenen Abfalltonne abgebildet. Es weist darauf hin, dass eine Entsorgung im normalen Haushaltsabfall nicht zulässig ist. Entsorgen Sie dieses Produkt im Recyclinghof mit einer getrennten Sammlung für Elektro- und Elektronikgeräte. Die Entsorgung muss gemäß den örtlichen Bestimmungen zur Abfallbeseitigung erfolgen. Bitte wenden Sie sich an die zuständigen Behörden Ihrer Gemeindeverwaltung, an den lokalen Recyclinghof für Haushaltsmüll oder an den Händler, bei dem Sie dieses Gerät erworben haben, um weitere Informationen über Behandlung, Verwertung und Wiederverwendung dieses Produkts zu erhalten.

GB This appliance is marked according to the European directive 2002/96/EC on Waste Electrical and Electronic Equipment (WEEE). By ensuring this product is disposed of correctly, you will help prevent potential negative consequences for the environment and human health, which could otherwise be caused by inappropriate waste handling of this product.

The symbol  on the product, or on the documents accompanying the product, indicates that this appliance may not be treated as household waste. Instead it shall be handed over to the applicable collection point for the recycling of electrical and electronic equipment. Disposal must be carried out in accordance with local environmental regulations for waste disposal. For more detailed information about treatment, recovery and recycling of this product, please contact your local city office, your household waste disposal service or the shop where you purchased the product.

F Cet appareil porte le symbole du recyclage conformément à la Directive Européenne 2002/96/CE concernant les Déchets d'Équipements Électriques et Électroniques (DEEE ou WEEE). En procédant correctement à la mise au rebut de cet appareil, vous contribuerez à empêcher toute conséquence nuisible pour l'environnement et la santé de l'homme.

Le symbole  présent sur l'appareil ou sur la documentation qui l'accompagne indique que ce produit ne peut en aucun cas être traité comme déchet ménager. Il doit par conséquent être remis à un centre de collecte des déchets chargé du recyclage des équipements électriques et électroniques.

Pour la mise au rebut, respectez les normes relatives à l'élimination des déchets en vigueur dans le pays d'installation. Pour obtenir de plus amples détails au sujet du traitement, de la récupération et du recyclage de cet appareil, veuillez vous adresser au bureau compétent de votre commune, à la société de collecte des déchets ou directement à votre revendeur.

NL Dit apparaat is voorzien van het merkteken volgens de Europese richtlijn 2002/96/EG inzake Afgedankte elektrische en elektronische apparaten (AEEA).

Door ervoor te zorgen dat dit product op de juiste manier als afval wordt verwerkt, helpt u mogelijk negatieve consequenties voor het milieu en de menselijke gezondheid te voorkomen die anders zouden kunnen worden veroorzaakt door onjuiste verwerking van dit product als afval.

Het symbool  op het product of op de bijbehorende documentatie geeft aan dat dit product niet als huishoudelijk afval mag worden behandeld. In plaats daarvan moet het worden afgegeven bij een verzamelpunt voor recycling van elektrische en elektronische apparaten. Afhandeling moet worden uitgevoerd in overeenstemming met de plaatselijke milieuvoorschriften voor afvalverwerking. Voor nadere informatie over de behandeling, terugwinning en recycling van dit product wordt u verzocht contact op te nemen met het stadskantoor in uw woonplaats, uw afvalophalendienst of de winkel waar u het product heeft aangeschaft.

E Este aparato lleva el marcado CE en conformidad con la Directiva 2002/96/EC del Parlamento Europeo y del Consejo sobre residuos de aparatos eléctricos y electrónicos (RAEE). La correcta eliminación de este producto evita consecuencias negativas para el medioambiente y la salud.

El símbolo  en el producto o en los documentos que se incluyen con el producto, indica que no se puede tratar como residuo doméstico. Es necesario entregarlo en un punto de recogida para reciclar aparatos eléctricos y electrónicos. Deséchelo con arreglo a las normas medioambientales para eliminación de residuos. Para obtener información más detallada sobre el tratamiento, recuperación y reciclaje de este producto, póngase en contacto con el ayuntamiento, con el servicio de eliminación de residuos urbanos o la tienda donde adquirió el producto.

P Este aparelho está classificado de acordo com a Directiva Europeia 2002/96/EC sobre Resíduos de equipamento eléctrico e electrónico (REEE).

Ao garantir a eliminação adequada deste produto, estará a ajudar a evitar potenciais consequências negativas para o ambiente e para a saúde pública, que poderiam derivar de um manuseamento de desperdícios inadequado deste produto.

O símbolo  no produto, ou nos documentos que acompanham o produto, indica que este aparelho não pode receber um tratamento semelhante ao de um desperdício doméstico. Pelo contrário, deverá ser depositado no respectivo centro de recolha para a reciclagem de equipamento eléctrico e electrónico. A eliminação deverá ser efectuada em conformidade com as normas ambientais locais para a eliminação de desperdícios. Para obter informações mais detalhadas sobre o tratamento, a recuperação e a reciclagem deste produto, contacte o Departamento na sua localidade, o seu serviço de eliminação de desperdícios domésticos ou a loja onde adquiriu o produto.

I Questo apparecchio è contrassegnato in conformità alla Direttiva Europea 2002/96/EC, Waste Electrical and Electronic Equipment (WEEE). Assicurandosi che questo prodotto sia smaltito in modo corretto, l'utente contribuisce a prevenire le potenziali conseguenze negative per l'ambiente e la salute.

Il simbolo  sul prodotto o sulla documentazione di accompagnamento indica che questo prodotto non deve essere trattato come rifiuto domestico ma deve essere consegnato presso l'idoneo punto di raccolta per il riciclaggio di apparecchiature elettriche ed elettroniche. Disfarsene seguendo le normative locali per lo smaltimento dei rifiuti. Per ulteriori informazioni sul trattamento, recupero e riciclaggio di questo prodotto, contattare l'idoneo ufficio locale, il servizio di raccolta dei rifiuti domestici o il negozio presso il quale il prodotto è stato acquistato.

GR Αυτή η συσκευή φέρει σήμανση σύμφωνα με την Ευρωπαϊκή οδηγία 2002/96/EE σχετικά με Απορριπτόμενα Ηλεκτρικά και Ηλεκτρονικά Εξαρτήματα (WEEE). Εξασφαλίζοντας ότι το προϊόν αυτό απορριπτείται ουσιά, θα βοηθήσετε στην πρόληψη πιθανών αρνητικών επιπτώσεων για το περιβάλλον και την ανθρώπινη υγεία, οι οποίες θα μπορούσαν να δημιουργηθούν από τον ακατάλληλο χειρισμό αυτού του προϊόντος ως απόρριμμα.

Το σύμβολο  πάνω στο προϊόν, ή στα έγγραφα που συνοδεύουν το προϊόν, υποδεικνύει ότι αυτή η συσκευή δεν μπορεί να θεωρηθεί οικιακό απόρριμμα. Αντί για αυτό θα πρέπει να παραδοθεί στο κατάλληλο σημείο περισυλλογής για την ανακύκλωση των ηλεκτρικών και ηλεκτρονικών εξαρτημάτων. Διαλύστε το προϊόντας την τοπική νομοθεσία για τη διάθεση των απορριμμάτων. Για πιο λεπτομερείς πληροφορίες σχετικά με την επεξεργασία, την περισυλλογή και την ανακύκλωση αυτού του προϊόντος, παρακαλούμε επικοινωνήστε με το αρμόδιο γραφείο της τοπικής σας αυτοδιοίκησης, την τοπική σας υπηρεσία αποκομιδής οικιακών απορριμμάτων ή το κατάστημα όπου αγοράσατε αυτό το προϊόν.

S Denna produkt är märkt enligt EG-direktiv 2002/96/EEC beträffande elektriskt och elektroniskt avfall (Waste Electrical and Electronic Equipment, WEEE).

Genom att säkerställa en korrekt kassering av denna produkt bidrar du till att förhindra potentiella, negativa konsekvenser för vår miljö och vår hälsa, som annars kan bli följden om produkten inte hanteras på rätt sätt.

Symbolen  på produkten, eller i medföljande dokumentation, indikerar att denna produkt inte får behandlas som vanligt hushållsavfall. Den skall i stället lämnas in på en lämplig uppsamlingsplats för återvinning av elektrisk och elektronisk utrustning. Produkten måste kasseras enligt lokala miljöbestämmelser för avfallshantering. För mer information om hantering, återvinning och återanvändning av denna produkt, var god kontakta de lokala myndigheterna, ortens sophanteringsstjänst eller butiken där produkten inhandlades.

N Dette apparatet er mærket i samsvar med EU-direktiv 2002/96/EC om afhending af elektrisk og elektronisk udstyr (Waste Electrical and Electronic Equipment - WEEE). Forskær deg om at dette produktet blir avhendet på korrekt vis, slik at det ikke kan utgjøre noen helse- eller miljørisiko.

Symbol  på produktet eller på dokumentene som følger med det, viser at dette produktet ikke må behandles som husholdningsavfall. Lever det til et autorisert mottak for resirkulering av elektrisk og elektronisk ustyr. Avhenging må skje iht. de lokale renovasjonsforskriftene. For nærmere informasjon om håndtering, kassering og resirkulering av dette produktet, kontakt kommunen, renovasjonsvesenet eller forretningen der du anskaffet det.

DK Dette produkt er mærket i henhold til EU-direktiv 2002/96/EF om Kasseret elektrisk og elektronisk udstyr (WEEE). Ved at sikre, at dette produkt bliver skrotet korrekt, hjælper man med til at forhindre potentielle, negative konsekvenser for miljøet og folkesundheden, der kunne opstå gennem uhensigtsmæssig bortskaffelse af dette produkt.

Symbol  på produktet eller på dokumenterne, der ledsager produktet, angiver, at produktet ikke må bortskaffes sammen med husholdningsaffald. Det skal i stedet afleveres på en genbrugsstation for elektrisk og elektronisk udstyr. Det skal skrottes i henhold til gældende lokale miljøregler for bortskaffelse af affald. For yderligere oplysninger om håndtering, genvinning og genbrug af dette produkt bedes man kontakte de lokale myndigheder, renovationsselskabet eller forretningen, hvor produktet er købt.

FIN Tämä laite on merkitty WEEE-direktiivin (Waste Electrical and Electronic Equipment) 2002/96/EC mukaisesti. Varmistamalla, että tuote poistetaan käytöstä asianmukaisesti, voidaan auttaa estämään sellaiset ympäristö- ja terveysvaimat, jotka saattaisivat aiheuttaa jäätteen laistamasta käsitteystä.

Symbol  tuotteesta tai sen dokumentaatiosta tarkoittaa, ettei laitetta saa hävittää kotitalousjätteen mukana. Sen sijaan tuote on toimitettava sähkö- ja elektronikkakomponenttien keräys- ja kierrätyspisteeseen. Laitteen käytöstäpoiston suhteen on noudatettava paikallisia jätehuoltomaarayksia. Lisätietoja tuotteen käsittelystä, talteenotosta ja kierrätyksestä saa kaupungin- tai kunnanvirastosta, paikallisesta jätehuoltoilikeestä tai liikkeestä, josta tuote ostettiin.

PL Niniejsze urządzenie posiada oznaczenia zgodnie z Dyrektywą Europejską 2002/96/EC w sprawie zużytego sprzętu elektrycznego i elektronicznego (WEEE). Zapewniająca prawidłowe złomowanie niniejszego urządzenia przyczynia się Państwu do ograniczenia ryzyka wystąpienia negatywnego wpływu produktu na środowisko i zdrowie ludzi, które mogłyby zaistnieć w przypadku niewłaściwej utylizacji urządzenia.

Symbol  umieszczony na produkcie lub na dołączonych do niego dokumentach oznacza, że niniejszy produkt nie jest klasyfikowany jako odpad z gospodarstwa domowego. Urządzenie, w celu jego złomowania, należy zdać w odpowiednim punkcie utylizacji odpadów w celu recyklingu komponentów elektrycznych i elektronicznych. Urządzenie należy złomować zgodnie z lokalnymi przepisami dot. utylizacji odpadów. Dodatkowe informacje na temat utylizacji, złomowania i recyklingu opisywanego urządzenia można uzyskać w lokalnym urzędzie miasta, w miejskim przedsiębiorstwie utylizacji odpadów lub w sklepie, w którym produkt został zakupiony.

CZ Tento spotřebič je označen v souladu s evropskou směrnicí 2002/96/ES o likvidaci elektrického a elektronického zařízení (WEEE). Zajištěním správné likvidace tohoto výrobku pomůžete zabránit případným negativním důsledkům na životní prostředí a lidské zdraví, ke kterým by nevhodnou likvidací tohoto výrobku mohlo dojít.

Symbol  na výrobku nebo na dokumentech přiložených k výrobku udává, že tento spotřebič nepatří do domácího odpadu. Spotřebič je nutné odvézt do sběrného místa pro recyklaci elektrického a elektronického zařízení. Likvidace musí být provedena v souladu s místními předpisy o ochraně životního prostředí, které se týkají likvidace odpadu. Podrobnější informace o zpracování, recukeraci a recyklaci tohoto výrobku zjistíte u příslušného místního úřadu, služby pro likvidaci domovního odpadu nebo v obchodě, kde jste výrobek koupili.

SK Tento spotřebič je označen v súlade s Európskou smernicou 2002/96/ES o likvidácii elektrických a elektronických zariadení (WEEE). Zabezpečenie, že tento výrobok bude zlikvidovaný správnym spôsobom, pomôže predchádzať potenciálnym negatívnym dopadom na životné prostredie a ľudské zdravie, ktoré by sa v inom prípade mohli vyskytnúť pri nevhodnom zaobchádzaní pri likvidácii tohto výrobku.

Symbol  na výrobku alebo na sprievodných dokumentoch znamená, že s týmto výrobkom sa nesmie zaobchádzať ako s domovým odpadom. Naopak, treba ho odovzdať v zbernom stredisku na recykláciu elektrických alebo elektronických zariadení. Likvidácia musí byť vykonaná v súlade s predpismi na ochranu životného prostredia pre likvidáciu odpadu.

H A készüléket található jelzés megelözi az elektromos és elektronikus berendezések hulladékáiról szóló 2002/96/EK európai irányelvből (WEEE) foglalt előírásoknak. A hulladékéle váltó termék szabályszerű elhelyezésével Ön segít elkerülni a környezettel és az emberi egészséggel kapcsolatos azon esetleges negatív következményeket, amelyek a termék nem megfelelő hulladékkezelése egyébként okozhatna. A termékem vagy a termékhez mellékelt dokumentumokon feltüntetett

 jelzés arra utal, hogy ez a termék nem kezelhető háztartási hulladékként. Ehelyett a terméket a villamos és elektronikus berendezések újrahasznosítását végző telephelyek valamelyikén kell leadni. Kiselejtezőskor a hulladékkeltávolításra vonatkozó helyi környezetvédelmi előírások szerint kell eljárni. A termék kezelésével, hasznosításával és újrahasznosításával kapcsolatos bővebb tájékoztatásért forduljon a lakóhelye szerinti polgármesteri hivatalhoz, a háztartási hulladékok kezelését végző társasághoz vagy ahhoz a bolthoz, ahol a termékét vásárolta.

RUS Данное изделие промаркировано в соответствии с Европейской директивой 2002/96/EC по утилизации электрического и электронного оборудования (WEEE). Обеспечив правильную утилизацию данного изделия, Вы можете предотвратить потенциальные негативные последствия для окружающей среды и здоровья человека, которые могли бы иметь место в противном случае.

Символ  на самом изделии или сопроводительной документации указывает, что при утилизации данного изделия с ним нельзя обращаться как с обычными бытовыми отходами. Вместо этого, его следует сдавать в соответствующий пункт приема электрического и электронного оборудования для последующей утилизации. Сдача на слом должна производиться в соответствии с местными правилами по утилизации отходов. За более подробной информацией о правилах обращения с такими изделиями, их утилизации и переработки обращайтесь в местные органы власти, в службу по утилизации отходов или в магазин, в котором Вы приобрели данное изделие.

BG Този уред е маркиран в съответствие с Европейска директива 2002/96/EO "Електрическо и електронно оборудване за отпадъци" (WEEE). Като се погрижите това изделие да бъде изхвърлено по правилен начин, вие ще помогнете за предотвратяване на възможните негативни последици за околната среда и здравето на хората, което в противен случай може да бъде предизвикано от неправилно изхвърляне на това изделие.

Символът  върху изделието или върху документите, приложено към изделието, показва, че това изделие не бива да се третира като битови отпадъци. Вместо това, то трябва да се предава в специализиран пункт за рециклиране на електрическо и електронно оборудване. При изхвърлянето му спазвайте местните норми за изхвърляне на отпадъци. За по-подробна информация за третирането, възстановяването и рециклирането на това изделие се обрънете към вашата местна градска управа, към вашата служба за изхвърляне на битови отпадъци или към магазина, откъдето сте закупили изделието.

RO Acest aparat este marcat în conformitate cu Directiva Europeană 2002/96/CE referitoare la Desculearea de Echipament Electric și Electronic (WEEE). Asigurându-vă că acest produs este eliminat în mod corect, contribuiți la prevenirea potențialelor consecințe negative asupra mediului înconjurător și sănătății persoanelor, consecințe care ar putea fi provocate de aruncarea necorespunzătoare la gunoi a acestui produs.

Символ  de pe produs, sau de pe documente care însoțesc produsul, indică faptul că acesta nu poate fi aruncat împreună cu deșeurile menajere. Trebuie predat la punctul de colectare corespunzător, pentru reciclarea echipamentului electric și electronic. Aruncarea la gunoi a aparatului trebuie făcută în conformitate cu normele locale pentru eliminarea deșeurilor. Pentru informații mai detaliate privind eliminarea, valorificarea și reciclarea acestui produs, vă rugăm să contactați administrația locală, serviciul de eliminare a deșeurilor menajere sau magazinul de unde ați cumpărat produsul.

