

**CAN75.1SS Cooker
Hood**

Instruction manual

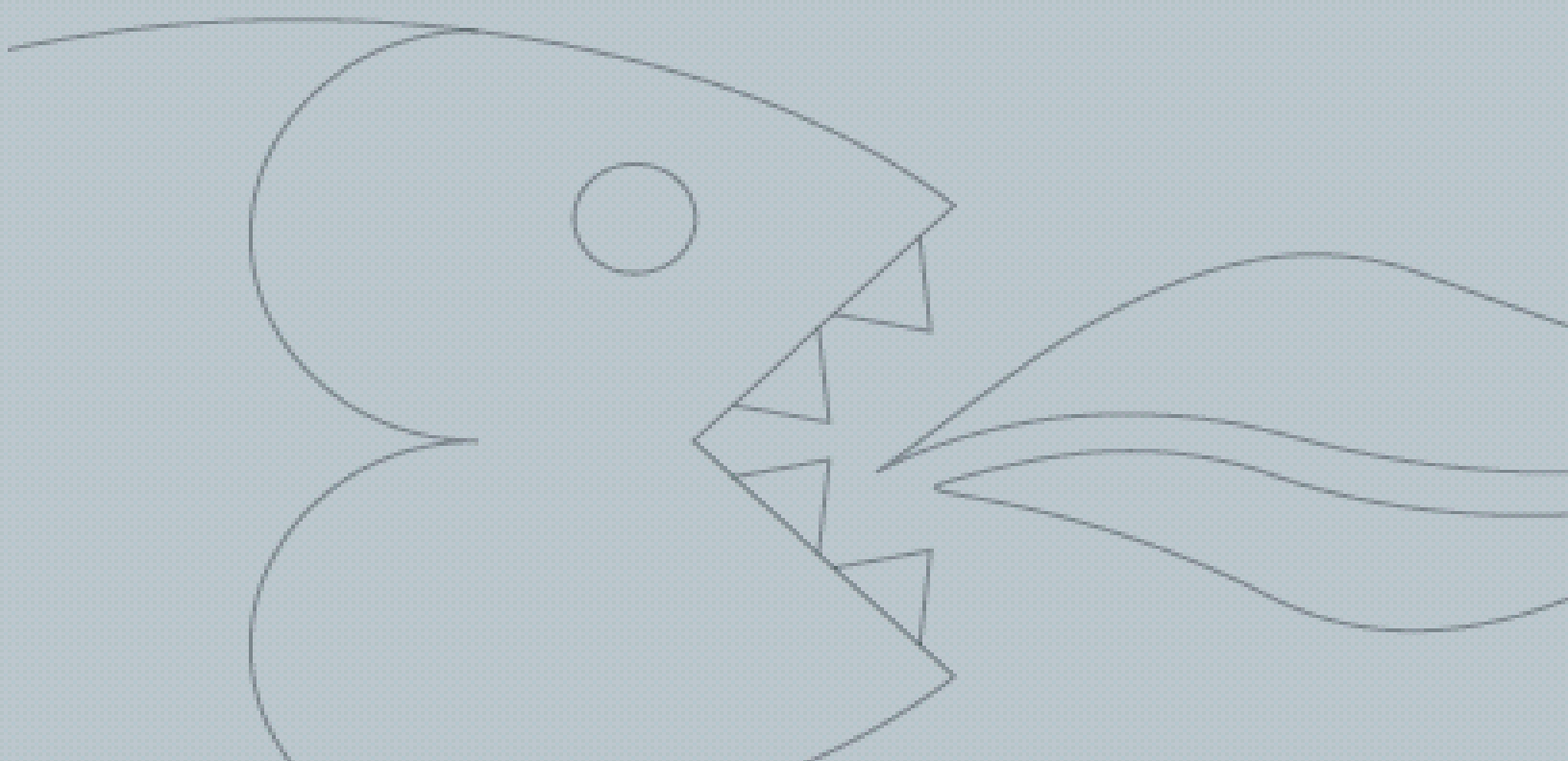

User Manual for your Baumatic

CAN75.1SS Cooker Hood



NOTE: This User Instruction Manual contains important information, including safety & installation points, which will enable you to get the most out of your appliance. Please keep it in a safe place so that it is easily available for future reference.

CONTENTS

YOUR COOKER HOOD'S SPECIFICATIONS3

IMPORTANT SAFETY INFORMATION.....4-5

CARING FOR THE ENVIRONMENT.....6

USING YOUR COOKER HOOD.....7

MAINTAINING AND CLEANING YOUR COOKER HOOD8-10

INSTALLATION INSTRUCTIONS11-14

CARBON FILTER11
ELECTRICAL CONNECTION.....12
INSTALLING THE COOKER HOOD.....13-14

TROUBLESHOOTING15

CONDITIONS OF GUARANTEE.....16

CONTACT DETAILS.....17

Specifications of your CAN75.1SS Cooker Hood

Congratulations on purchasing a Baumatic Cooker Hood!

To fully enjoy using your appliance long into the future, please firstly familiarise yourself with its specifications, safety advice and operational instructions included in this manual. You will also need this manual to ensure that your Cooker Hood has been installed properly.

DIMENSIONS

| | |
|---------|--------|
| Width: | 790 mm |
| Depth: | 300 mm |
| Height: | 165 mm |

Your stainless steel Cooker Hood is fitted with:

- Slider control operation
- 3 speeds
- 3 metallic grease filters
- 2 lights

Extraction capacity – 380 m³/hr

Optional Extra: 2 x UCF1 Carbon filters for air recirculation.

Important Safety Information: Please Read this before installing & using.

- ***Any installation work must be carried out by a qualified electrician or competent person.***

- ***The hood must be installed in accordance with the installation instructions and all measurements followed.***

- **If the cooker hood is installed for use above a gas appliance then the provision for ventilation must be in accordance with the Gas Safety Codes of Practice BS.6172, BS.5440 & BS.6891 (Natural Gas) and BS.5482 (LP Gas) 1994, the Gas Safety (Installation & Use) Regulations, the Building Regulations issued by the Department of the Environment, the Building Standards (Scotland) (Consolidated) Regulations issued by the Scottish Development Dptmt.**



- **It is dangerous to alter the specifications or to modify this product in any way. Do not tamper with it or attempt to alter it in the attempt to customise it further.**



- **When installing the hood, ensure that the following recommended distances are being observed between the cooker top and the bottom of the cooker hood:**

- ✓ **Electric cookers:
700 mm**
- ✓ **Gas cookers:
700 mm**
- ✓ **Coal/ oil cookers:
800 mm**

*** NOTE - DO NOT SET YOUR COOKER HOOD LESS THAN 700mm ABOVE YOUR COOKER!**

- **When installed between adjoining wall cabinets, the cabinets must not overhang the hob and their undersides must be at least 50 mm off from the hob edges.**
- **The edges of the cooker hood are sharp – be mindful of this as you handle your appliance, especially during installation and cleaning. *DO NOT CLEAN IN BEHIND THE GREASE FILTERS!***
- **If the room where the cooker hood is to be used contains a fuel burning appliance such as a central heating boiler then its flue must be of the sealed or balanced flue type.**
- **If other types of flue or appliances are fitted, ensure that there is an adequate supply of air in the room.**
- **When the hood is being used in its extractor function, ensure that the ducting is fire retardant and that there are no bends sharper than 90 degrees as this will reduce the efficiency of the hood.**

Important Safety Information: Please Read this before installing & using.

- Ensure the ducting for the extractor function has the same diameter as the outlet hole all the way through.
- *Keep young children from using, playing with or tampering with the cooker hood. Older children and infirm persons should be supervised if they are using the cooker hood.*
- *Your cooker hood is for domestic use only.*
- *Please dispose of the packing material carefully – children are especially vulnerable to it.*
- *Dirty oil is an even greater fire risk.*
- *Always put lids on pots and pans when cooking on a gas cooker.*
- *The manufacturer refuses to accept any responsibility for damages arising to the hood or its catching on fire from failure to observe fire safety advice in these instructions.*
- *Remember that when in extraction mode, your cooker hood is removing air from your room. Ensure that proper*



ventilation measures are being observed. Note that it removes odours from your room, not steam.

- **Warning - Always ensure that the cooker hood has been disconnected from the power supply before carrying out any work on the hood, including replacing light bulbs.**

- ☒ **Do not connect the ducting system of this appliance to any existing ventilation system which is being used for any other purpose.**
- ☒ **Do not install above a cooker with a high level grill.**
- ☒ **Never leave frying pans unattended during use as overheated fats and oils might catch fire.**
- ☒ **Do not leave naked flames under the cooker hood.**
- ☒ **Do not attempt to use the cooker hood if it is damaged in any way. Never attempt to use it without the grease filters fitted or if the filters are excessively greasy!**
- ☒ **Never flambé cook under this cooker hood.**

Environmental Note

Note: Before discarding an old appliance, switch off and disconnect it from the power supply. Cut off and render any plug useless. Cut the cable off directly behind the appliance to prevent misuse. This should be undertaken by a competent person.

CONFORMITY TO W.E.E.E. DIRECTIVE

This appliance is marked according to the European directive 2002/96/EC on Waste electrical and Electronic Equipment (WEEE). By ensuring this product is disposed of correctly, you will help prevent potential negative consequences for the environment and human health, which could otherwise be caused by inappropriate waste handling of this product.

The symbol  on the product, or on the documents accompanying the product, indicates that this appliance may not be treated as household waste. Instead it shall be handed over to the applicable collection point for the recycling of electrical and electronic equipment.

Disposal must be carried out in accordance with local environmental regulations for waste disposal.

For more detailed information about treatment, recovery and recycling of this product, please contact your local city office, your household waste disposal service or the shop where you purchased the product.

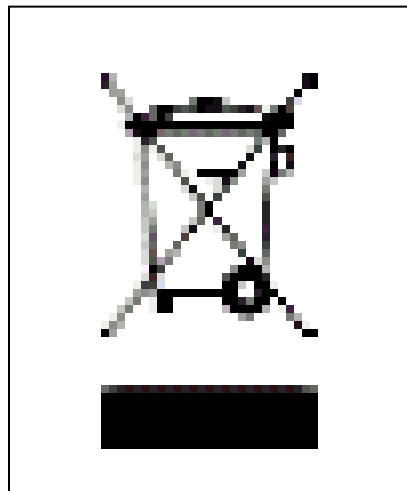

Using your Baumatic Cooker Hood:

To use your cooker hood:

- 1) Make sure it has been properly installed.
- 2) Find the CONTROL PANEL. It is located on the hood's front surface near the right corner of the unit.
- 3) The CONTROL PANEL contains two rows of switches. These perform separate functions. You will need to understand what both switches do before you attempt to use your cooker hood.

*** Note: The hood should be switched on at least as soon as you start cooking. It is a good idea to have had it running for 5 minutes prior to cooking and at least 15 minutes after you have finished cooking.**

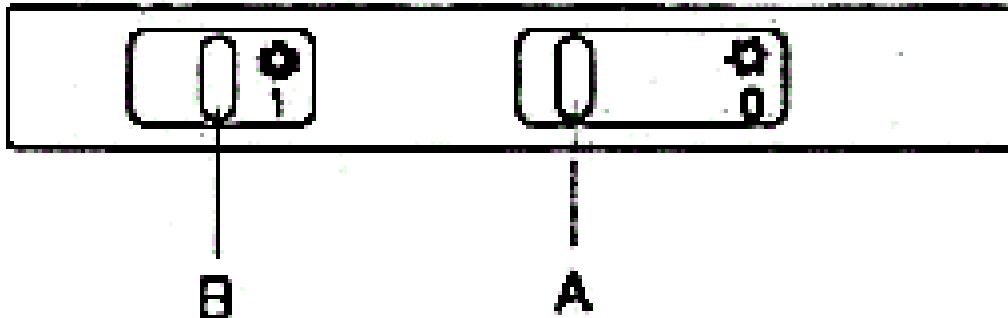

One row of sliding switches is for the cooker hood's operation

MOTOR ON /OFF switch – the '⚙️' switch ('A' in figure above) turns the motor on and off and adjusts its speed. There are three speeds, pushing the switch to the right increases the speeds. The leftmost setting is 'OFF'.

The other is to control the light.

LIGHT ON/OFF switch - Pressing the '💡' switch ('C' in figure above) turns your cooker hood's light on (push left) and off (push right).

PLEASE NOTE THAT YOUR BAUMATIC COOKER HOOD CAN BE USED EITHER IN RECIRCULATION MODE OR IN EXTRACTION MODE. TO USE IN RE-CIRCULATION MODE, YOU WILL NEED TO FIT THE CARBON FILTER.

Cleaning your Baumatic Cooker Hood:

*** IMPORTANT!:** *Before cleaning, always ensure that you have switched your cooker hood OFF at the omni-polar switch, set at the wall from the cable:*

Cleaning

- ⤷ Clean the external parts with mild liquid detergents on a damp cloth.
- ⤷ Never use abrasive powder, corrosive solvents or brushes.
- ⤷ Never insert pointed objects into the motor's protective grid.
- ⤷ Only clean the control panel and filter grill with a damp cloth and delicate detergents.
- ⤷ Be sure to replace the carbon filters at the recommended intervals. Build up could cause a fire hazard.
- ⤷ Never take out the grease filters and attempt to clean the space above where they are set.

Anti-Grease Grille

- ⤷ Your cooker hood includes an anti-grease grille which helps absorb vapour-suspended grease particles to protect your kitchen & furniture from greasy residues.
- ⤷ The metal grille may become inflammable if it becomes saturated with greasy residue.

- ✓ To prevent this fire hazard, the grille should be cleaned regularly (depending on use) every 10-15 days and at least every three months in a dishwasher or in hot water with normal washing-up detergent.

Maintenance - Cleaning the Anti-grease Filters

Grease Filter
Release

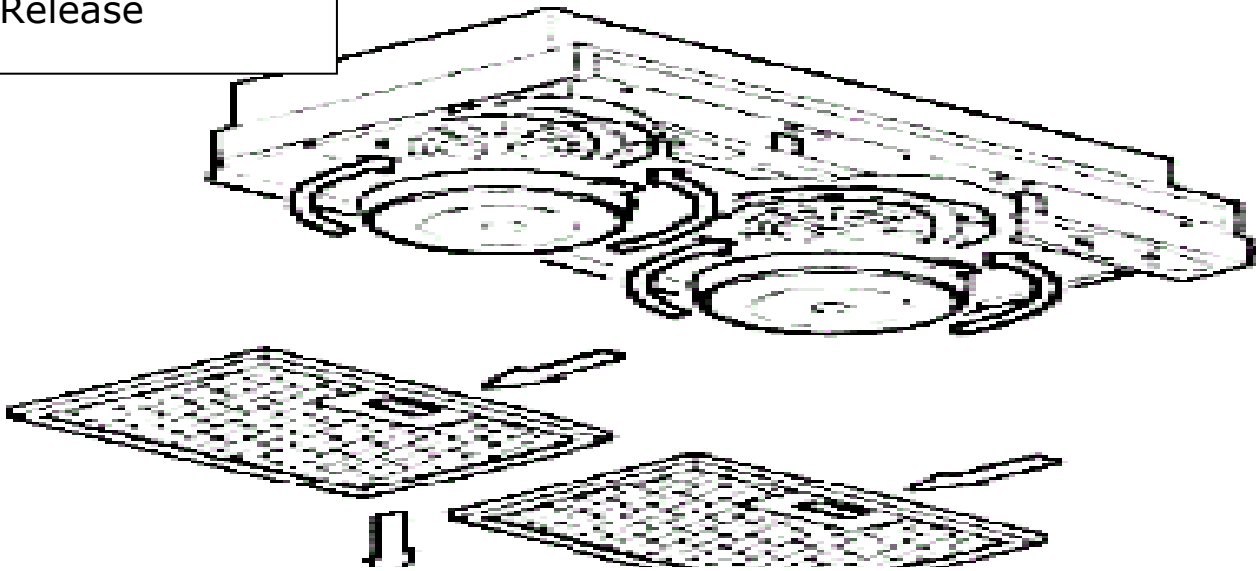

First remove the anti-grease filter by pulling in the triggers on the sides of the grille (or, for those models with inset handholds) on the underside of the hood.

- You can now clean the anti-grease grille.

To clean the grille by hand:

- ✓ Soak them for about one hour in hot water with a grease-loosening detergent then rinse off thoroughly with hot water.
- ✓ Repeat the process if needed. Refit the grease grille once it has dried.

To clean the grilles in your dishwasher:

- ✓ Place the grease grilles in the dishwasher. Select the most powerful washing programme and highest temperature.
- ✓ Repeat the process, if necessary.
- ✓ Refit the grease grille when it is dry. Do not worry about the slight discolouration of the grille – its performance won't be affected.

REMEMBER THAT DISCOLOURATION OF THE GREASE FILTER CAN TAKE PLACE WHEN CLEANED IN A DISHWASHER – THIS IS NORMAL.

*** NOTE - After carefully rinsing and drying the anti-grease grille, put it back in place. Never put it back in wet!**

Maintenance - Changing the Light Bulb

a) Changing the light bulb

- ✓ **Before changing the light bulb, ensure that the appliance is not live (i.e., ensure that you have switched it off).**
- ✓ **Remove the anti-grease grille to access the lamp area (see previous page).**
- ✓ **Remove the damaged light bulb.**
- ✓ **Change the incandescent bulb using only olive-shaped spares with an E14 coupling, max. 40W.**

*** PLEASE NOTE - Defective bulbs should be replaced immediately.**

- ✓ **Replace the metal anti-grease filter grille.**

Installing / Changing the Carbon Filter

Your Baumatic Cooker Hood uses **CARBON FILTERS** to purify the air for the air recirculation function.

You will find that one filter will attach over the front of the fan motor (please see figure at bottom of page).

The active carbon filter must be replaced regularly, at least once every four months, to allow normal operation.

Before starting to fit the carbon filter, turn the omni-polar switch OFF!

Changing the Carbon Filters – Note: carbon filters cannot be cleaned!

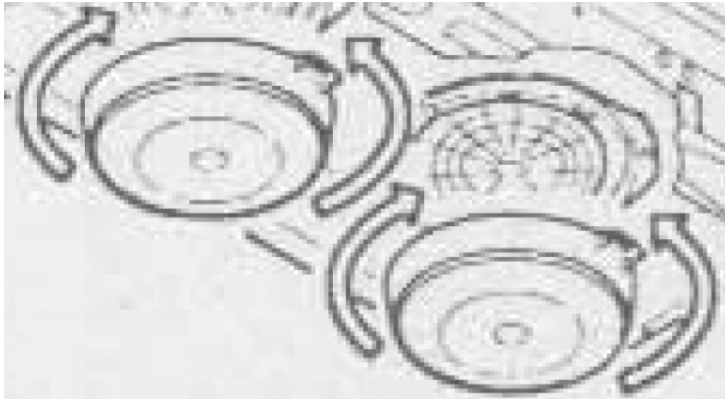

3) Place the new carbon filter over the motor bracket, making sure that the centre button fits exactly into the hole on the bracket. Press lightly until it snaps into place then insert the centre peg.

4) Replace the anti-grease filter grille.

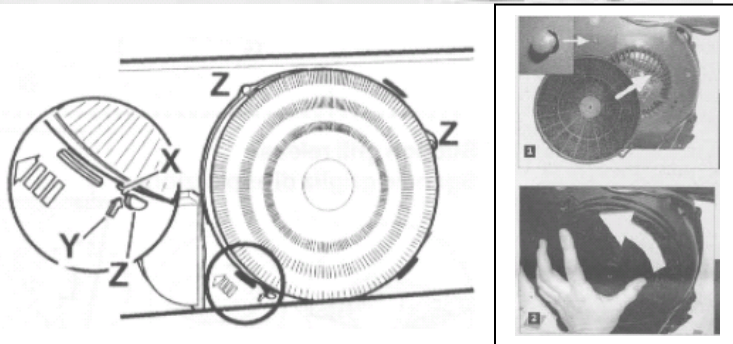

1) Remove the metal grease filter grille (see page 9).

2) Take carbon filter and extract centre peg on it about 10mm. (If changing, remove the old carbon filter by rotating it until it unlatches from the sides of the motor).

NOTE

If your filter is different (i.e. is the Bayonet Circular-insert type, Position the filter P in order to cover the motor protection grille, ensuring that the 'X' on the filter lines up with the 'Y' on the conveyor. Then turn clockwise. Reverse to dismount

INSTALLATION INSTRUCTIONS - Electrical

Before installation and usage, read all the instructions and make sure that the voltage (V) and the frequency (Hz) indicated on the identification plate (found inside your Cooker Hood) and all the data inside the appliance are exactly the same as the voltage and frequency in your home.

NOTE: The manufacturer declines all responsibility in the event of failure to observe all the accident-prevention regulations in force which are necessary for normal use and regular operation of the electric system.



ELECTRICAL CONNECTION

Your cooker hood is intended for **fitted and permanent installation.**

- The power cable must be connected to the terminals marked L (live) and N (neutral) in the hood and fixed with a cable clamp.
- The cooker hood's power cable must be fitted upstream from the electrical connection using an omni-polar switch with a contact distance of at least 3mm.

NOTE: (UK only) **WARNING – THIS APPLIANCE MUST NOT BE EARTHED.** It should only be connected by a competent person using fixed wiring via a **DOUBLE POLE SWITCHED FUSED SPUR OUTLET.**

We recommend that the appliance is connected by a qualified electrician who is a member of the N.I.C.E.I.C. and who will comply with the I.E.E. and local regulations. The wires in the mains lead are coloured in accordance with the following U.K. code:

Blue= Neutral, Brown = Live, Green/Yellow = Ground

If you can only find two wires in the cable (blue and brown), neither must be connected to the Earth terminal!

- As the colours of the wires in the appliance's mains lead may not correspond with the coloured markings identifying the terminals in your spur box, please proceed as follows:

1) The **BLUE WIRE** must be connected to the terminal marked 'N' (Neutral), or coloured Black.

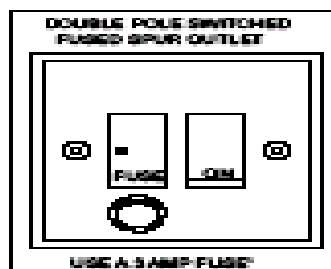

2) The **BROWN WIRE** must be connected to the terminal marked 'L' ('Live'), or coloured RED (Fig. 7 – at left)

Fig. 7 ONLY FOR U.K.

INSTALLATION INSTRUCTIONS – installing your Cooker Hood



PLEASE NOTE THAT YOU WILL HAVE TO DECIDE BEFORE INSTALLING YOUR COOKER HOOD THAT YOU CAN ADAPT IT AS AN EXTRACTION FAN. PLEASE SEE BOXED NOTE BELOW ON PREPARING THE CABINET.

ALL NEEDED SCREWS & RAWLPLUGS ARE INCLUDED INSIDE YOUR HOOD.

- ⊗ ***The cooker hood must not be fitted above stoves with a radiant top plate.***
- ⊗ ***We recommend that at least two people install this hood.***
- ⊗ ***Do not tile, grout or silicone this hood to the wall.***

- 1) Your Baumatic Cooker Hood should only be fitted into the underside of a dedicated cabinet / kitchen unit. Do NOT position it any less than 700 mm (70 cm) above the hob.
- 2) Remove the metal anti-grease grille.

Preparing the cabinet Note: '(E)' will appear at the beginning of an instruction concerning how to fit the unit for the extraction function.

- 3) Create an opening in the bottom of the cabinet to insert the cooker hood and (E) drill a hole in the top of the cabinet to fit the discharge (extraction) tube.
- 4) (E) Connect the cooker hood to an external pipe, predispose the electrical connection.
- 5) Remove the grill or the anti-grease filter. Remove the frame 'C' provided by pressing on the two release hooks ('D' in picture).
- 6) Insert the cooker hood into the opening. Note – your cooker hood comes with fixing screws (as shown in figures below).

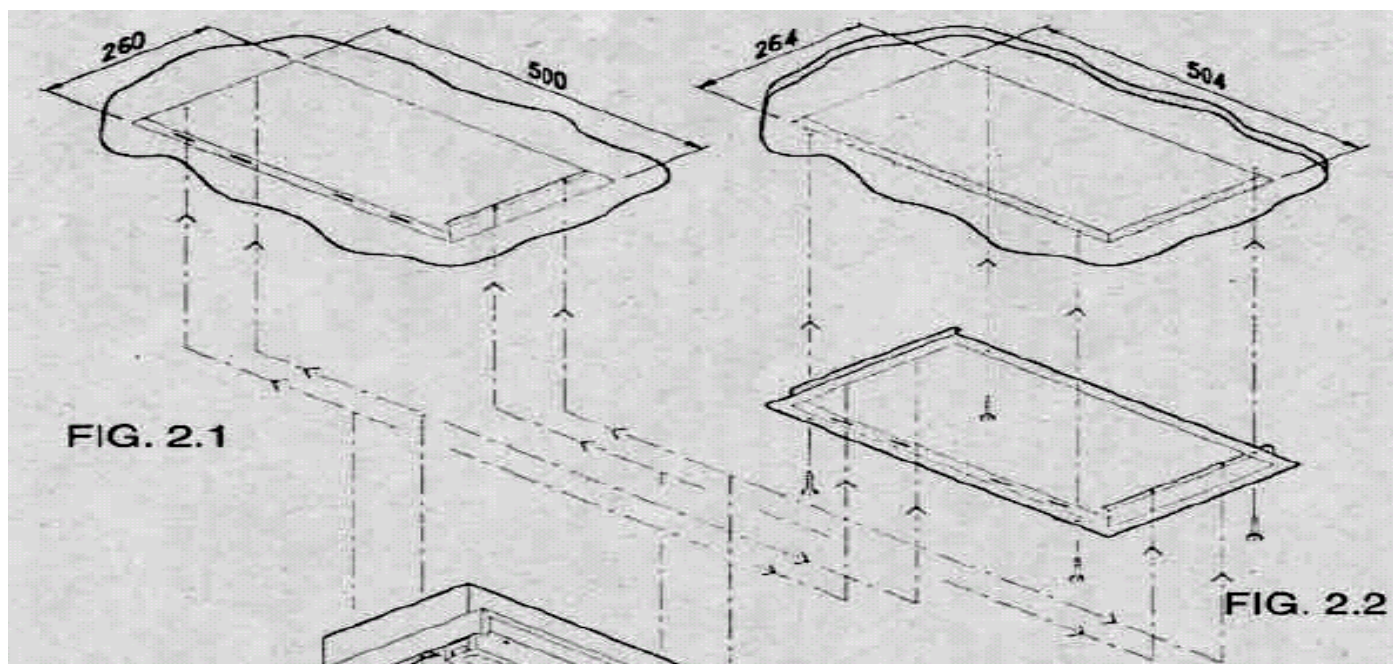

INSTALLATION INSTRUCTIONS – installing your Cooker Hood

Remember! Connect ducting for extraction function if you intend to use your hood as an extractor.

Ensure that you use 125mm ducting and that an exhaust hole of about 130mm is bored into your cabinet / kitchen unit to accommodate it.

- 7) Finally, fix the cooker hood to the cabinet with the wood screws supplied ('G' in figure).**
- 8) Remount the frame (if provided) and the suction (grease filter) grille ('H')**

Note on Connecting spigot for ducting to your cooker hood. Your hood must be connected to its exhaust spigot by the following method.

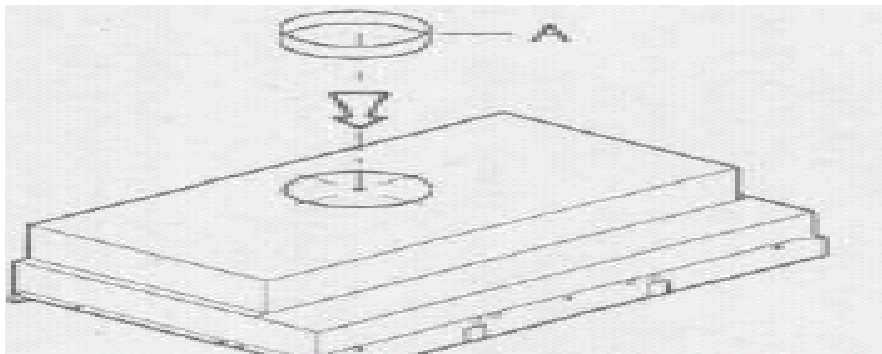

REMEMBER TO KEEP YOUR HOOD SECURE WHILE YOU WORK IT INTO PLACE!

Troubleshooting

If something has gone wrong with your Cooker Hood, checking against this chart might keep you from having to call for service.

| Symptom | Solution |
|--|---|
| <i>The cooker hood will not start!</i> | <ul style="list-style-type: none">• Check that the hood is connected to the electricity supply.• Check that the fan speed control is set properly. |
| <i>The cooker hood is not working effectively!</i> | <ul style="list-style-type: none">• The fan speed is not set high enough.• The grease filter is dirty.• The kitchen is not ventilated well enough.• If the hood is set for recirculation, check that the carbon filters have not expired.• If the hood is set for extraction, check that the ducting and outlets are not blocked. |
| <i>The cooker hood has switched off during operation!</i> | <ul style="list-style-type: none">• The safety cut-out device has been tripped.• Turn off the hob and then wait for the device to reset.• Note that if you have installed your cooker hood too low, this will happen. If it happens frequently, it will be damaged. |

Baumatic Ltd. Conditions of Guarantee

Dear Customer,

Your new Baumatic appliance comes complete with a free 12 month guarantee covering both parts and labour costs resulting from defective materials or workmanship.

Baumatic also gives you the opportunity to automatically extend the guarantee period for a further 12 months at no extra cost, giving an initial guarantee period of 24 months. The extended guarantee period applies to England, Scotland, Wales and Northern Ireland only.

To qualify for your full 24 months guarantee you **must** register your appliance within 28 days of purchase to be covered under this guarantee. This can be done online via: www.baumatic.co.uk or through returning the guarantee card which can be found in each new Baumatic appliance.

* In addition, your appliance is covered by a 5 year parts warranty. Baumatic Ltd will provide free of charge the parts required to repair the appliance, only if they are fitted by a Baumatic engineer, for any defect that arises due to faulty materials or workmanship within a period of 5 years from the original purchase date.

* An additional 1 to 3 year insurance scheme for labour is available should you wish to extend the warranty period.

Should any person other than an authorised representative of Baumatic Ltd interfere with the appliance, the policy is negated and Baumatic Ltd will be under no further liability.

The guarantee covers the appliance for normal domestic use only, unless otherwise stated.

Any claims made under the terms of the guarantee must be supported by the original invoice/bill of sale issued at the time of purchase.

This guarantee is transferable only with the written consent of Baumatic Ltd.

If the appliance fails and is considered either not repairable or uneconomical to repair during the manufacturer warranty period, a free of charge replacement will not be offered.

The guarantee for any replacement will only be for the remainder of the guarantee on the original product purchased.

The guarantee does not cover:

- Sinks and taps
- Failure to comply with the manufacturers instructions for use.
- The replacement of cosmetic components of accessories
- Accidental damage or wilful abuse.
- Subsequent loss or damage owing to the failure of the appliance or electrical supply
- Incorrect installation
- Losses caused by Acts of God, civil war, failure to obtain spare parts, strikes or lockouts
- Filters, fuses, light bulbs, external hoses, damage to bodywork, paintwork, plastic items, covers, baskets, trays, shelves, burner bases, burner caps, decals, corrosion, rubber seals.

In the course of the work carried out it may be necessary to remove the appliance from it operating position. Whilst all reasonable care will be taken, Baumatic Ltd cannot accept responsibility for damage sustained to any property whatsoever in this process.

This guarantee is in addition to and does not diminish your statutory or legal rights.

Contacting Baumatic Ltd

| Sales | Service | Spares | Technical/Advice |
|--------------------|--------------------|--------------------|------------------|
| TEL: 0118 933 6900 | TEL: 0118 933 6911 | TEL: 0118 933 6922 | 0118 933 6933 |
| FAX: 0118 931 0035 | FAX: 0118 986 9124 | FAX: 0118 933 6942 | 0118 933 6942 |

For ROI (Republic of Ireland), please contact one of the numbers below:

TEL: 01 – 6266798 FAX: 01 - 6266634

Thanks you for buying Baumatic.

* Applies to UK, Scotland, Wales & Northern Ireland only (Republic of Ireland has 1 year labour & 1 year parts warranty only)

Baumatic Ltd

Make-up for your kitchen

Headquarters

Baumatic Ltd.
Baumatic Buildings,
6 Bennet Road,
Reading,
Berkshire
RG2 0QX, United Kingdom

Sales Telephone
+44 118 933 6900

Sales Fax
+44 118 931 0035

Service Telephone
+44 118 933 6911

Service Fax
+44 118 986 9124

Spares Telephone
+44 118 933 6922

Technical / Advice Telephone
+44 118 933 6933

E-mail:

sales@baumatic.co.uk

technical@baumatic.co.uk

Http (Internet site):
www.baumatic.com

Baumatic UK/cod. 1230000666



Baumatic

www.baumatic.com