

**MG6/SB6/TG6  
Fridge/freezer**

**Instruction manual**

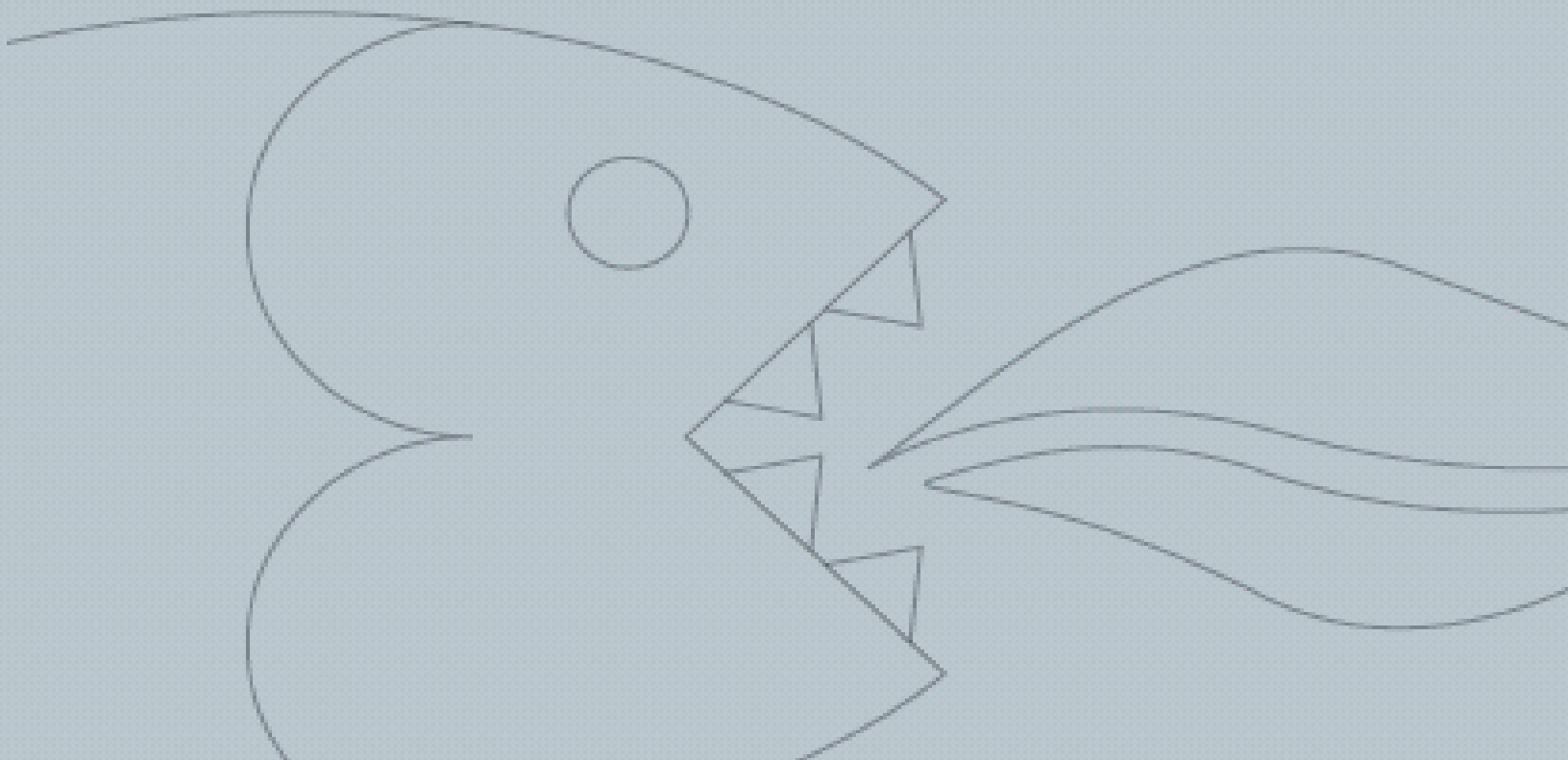

# USER MANUAL FOR YOUR BAUMATIC

## MG6/SB6/TG6 Fridge/freezer





*You will be mine*

***NOTE:*** This User Instruction Manual contains important information, including safety & installation points, which will enable you to get the most out of your appliance. Please keep it in a safe place so that it is easily available for future reference, for you or any person not familiar with the operation of the appliance.

DD 27/09/06

# Contents

<b>Environmental note</b>	4
<b>Important safety information</b>	5 – 6
<b>Specifications of your fridge freezer</b>	7
Description of the appliance	8
Description of the product features	9
<b>Using your Baumatic fridge freezer</b>	10
Before switching on	10
During first use	10
Turning on the appliance and setting the thermostat	11
<b>Arranging and storing food in the fridge section</b>	12
<b>The  freezer compartment</b>	13
Freezing fresh food	13-14
Tips on freezing	14
Making ice cubes	14
<b>Cleaning and maintenance</b>	15
Defrosting the refrigerator compartment	16
Defrosting the  freezer compartment	16-17
Replacing the light bulb	18
<b>Installation</b>	19
Electrical connection	19
Positioning	20
<b>Troubleshooting</b>	21
<b>Baumatic Ltd. conditions of guarantee</b>	22
<b>Contact details</b>	23

## Environmental note

**Note:** Before discarding an old appliance, switch off and disconnect it from the power supply. Cut off and render any plug useless. Cut the cable off directly behind the appliance to prevent misuse. This should be undertaken by a competent person. Disable the door lock to make sure that children cannot get stuck inside the appliance.

This appliance is marked according to the European directive 2002/96/EC on Waste electrical and Electronic Equipment (WEEE). By ensuring this product is disposed of correctly, you will help prevent potential negative consequences for the environment and human health, which could otherwise be caused by inappropriate waste handling of this product.

The symbol  on the product, or on the documents accompanying the product, indicates that this appliance may not be treated as household waste. Instead it shall be handed over to the applicable collection point for the recycling of electrical and electronic equipment.

Disposal must be carried out in accordance with local environmental regulations for waste disposal.

For more detailed information about treatment, recovery and recycling of this product, please contact your local city office, your household waste disposal service or the shop where you purchased the product.



## Important safety information



Your safety is of the utmost importance to Baumatic. Please make sure that you read this instruction booklet **before** attempting to install or use the appliance. If you are unsure of any of the information contained in this booklet, please contact the Baumatic Technical Department.

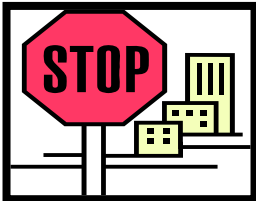

**IMPORTANT: Any installation work must be carried out by a qualified electrician or competent person.**

### Use of the appliance

- Your appliance is only designed to be used in the home. It is suitable for storing food that needs to be chilled and refrigerated. If it is used for any other purpose or it is not used correctly, then Baumatic Ltd. Will accept no liability for any damage that may be caused.
- Altering the specification of the appliance must not be attempted for reasons of safety.



### Before using your appliance

- Check the appliance for any signs of transport damage. If you notice any damage, then you should not connect your appliance to your mains supply and should contact your retailer.

### Refrigerant

- Your appliance contains R600a refrigerant, which is a natural gas that does not contain CFCs that can damage the environment. However it is a flammable substance, therefore care should be taken:
  - During the transportation and installation of the appliance, make sure that the refrigeration pipework does not get damaged.
  - If it does become damaged then sources of ignition and open flames should be avoided. Also the room that the appliance is situated in should be thoroughly ventilated.
- Do not place any objects on top of the appliance, as this may damage the table top.



## Child safety

- Packaging material should be kept away from children.
- Children should not be allowed to touch the controls or play with the appliance.



## General safety

- Do not pull on the power supply cable to remove the plug from your mains supply socket.
- Do not pull out or insert the plug with wet hands.
- Do not attempt to use your appliance outdoors or any place where it is likely to come into contact with the elements.
- Before cleaning the appliance or performing maintenance work, ensure that the appliance has been disconnected from your mains supply.

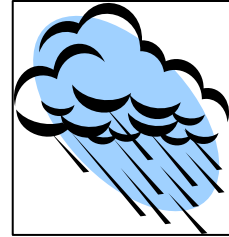

- Never allow the back coils of the appliance to come into contact with the wall surface.
- Always ensure that the location where you are installing your appliance is free of stored items such as papers and other flammable materials.
- Never block the ventilation openings of the appliance, either on the inside or its exterior.

- It is vital to keep your appliance well ventilated, so that there is proper air flow between the bottom of the unit and the plinth/kick plate which it is sitting on.

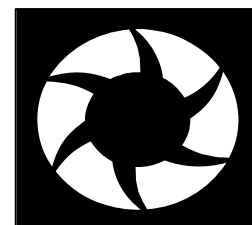

- Do not place electrical devices inside of the appliance, such as mixers or ice cream makers.

## Service

You should not attempt to repair the appliance yourself, as this could cause injury or a more serious malfunction. If you require a service call then please contact the Baumatic Service Department.

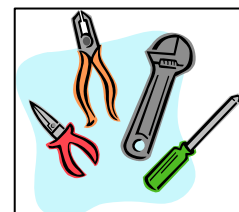

## Specifications of your fridge freezer

### Congratulations on purchasing a Baumatic fridge freezer

- Automatic defrost (fridge section only)
- Adjustable thermostat
- Electronic control
- Fast freeze switch
- Anti bacterial surface
- Temperature rise warning light
- 2 Egg racks
- Butter compartment
- 2 General racks
- 3 door shelves
- 3 Safety glass shelves
- 1 Salad crisper
- 3 Freezer drawers
- Adjustable feet
- Stainless steel front and sides

### Dimensions of appliance

Height: 1800 mm

Width: 600 mm

Depth: 640 mm

### Energy efficiency class

Energy class: A+

\* Please refer to the installation instructions for more specific information on the size of aperture that you will require.

**IMPORTANT:** When you install your appliance it is important to bear in mind its climatic rating.

In order to find out the climatic rating of your appliance, you should check the rating plate. The rating plate is located on the front left edge of the inside of the fridge section. You will need to open the door of your appliance to be able to find it. The rating plate will indicate the ambient temperature range that your appliance will function correctly within.

**Description of the appliance**

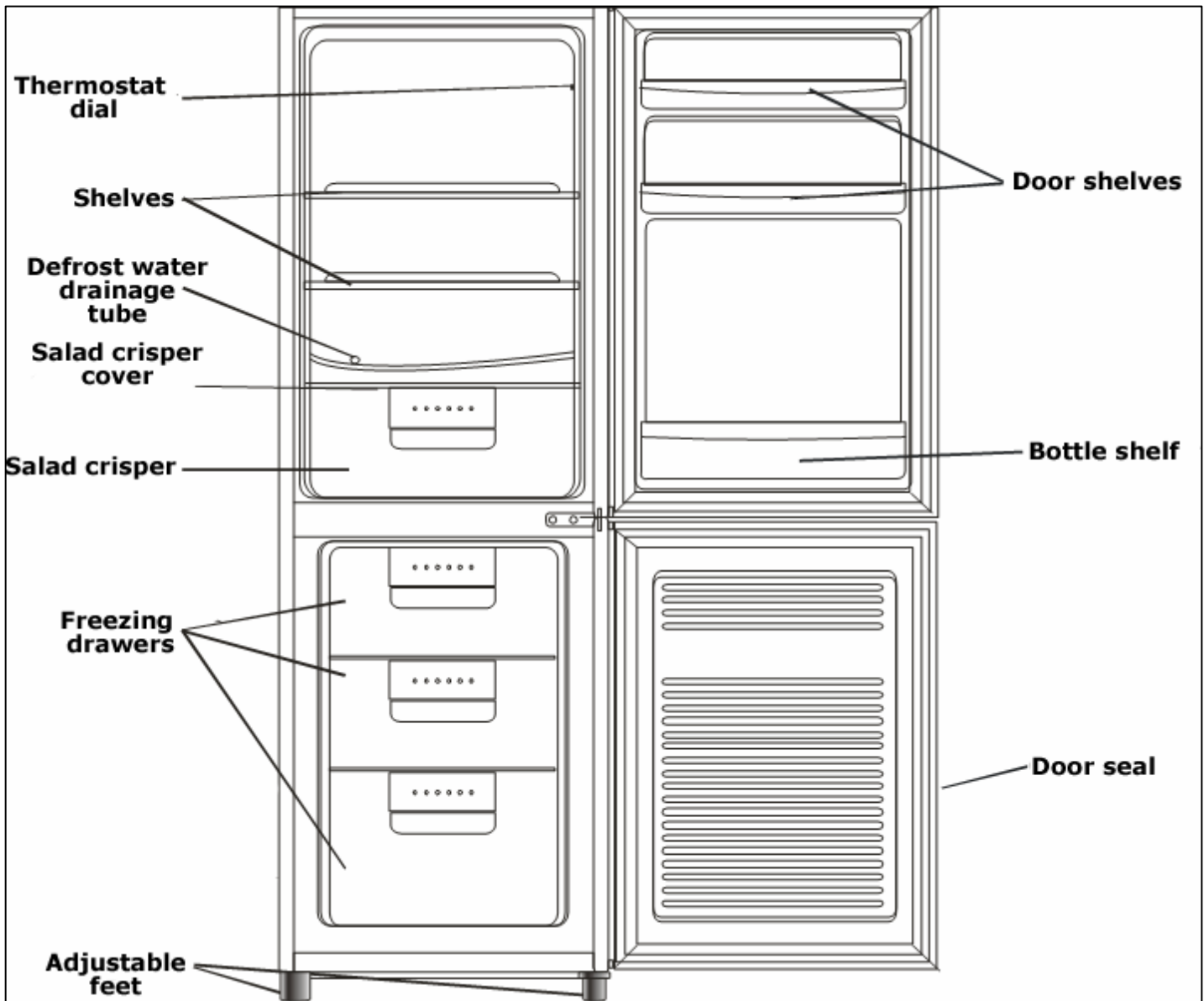



## Description of the product features

### 1) Shelves

- The shelves may be placed in any of the guide slots within the interior of the appliance. They are protected from sliding out.
- To remove a shelf: Take off all of the items that are stored on the shelf that you want to remove. Then lift the front of the shelf and carefully pull it out of the grooves.

### 2) Defrost water outlet

- The interior of the refrigerator is cooled by the cooling plate that is on the rear wall. Beneath this there is a channel and an outlet for the defrost water.
- It is important that this channel never becomes clogged (see "Defrosting the refrigerator compartment" for a detailed explanation of how to keep the channel clear).

### 3) Crisper drawer and cover

- The crisper drawer is in the bottom of your refrigerator and there is a cover that goes over them.
- The cover helps to prevent fruit and vegetables from drying out prematurely.

### 4) Upper door shelves

- The door liner holds various shelves, which are suitable for storing eggs, cheese, butter and yogurt. As well as smaller packages, tubes, cans etc.

### 5) Bottle shelf

- The lower shelf should be used for storing reasonably sized bottles.
- **IMPORTANT: IT IS IMPORTANT THAT NONE OF THE SHELVES THAT SIT IN THE DOOR ARE OVERLOADED, AS THIS WILL DRASTICALLY REDUCE THEIR WORKING LIFE.**

### 6) Freezer compartment

- A  freezer section, with a net capacity of 86 litres.

## Using your Baumatic fridge freezer

### Before switching on

- Make sure that it has been installed by a suitably qualified person, as per the information contained in Baumatic's installation instructions.
- After delivery, wait for eight hours before connecting the appliance to your mains supply. This will allow any refrigerant gasses that may have been disturbed during the transportation process, are allowed to settle.
- The outside of the appliance and the removable accessories contained within it, should be cleaned with a solution of liquid detergent and water.
- The interior of the appliance should be cleaned with a solution of sodium bicarbonate dissolved in lukewarm water. The interior and accessories should be thoroughly dried, after the cleaning process has been completed.
- There can be an odour when you first switch on the appliance. It will lessen as the appliance starts to cool.

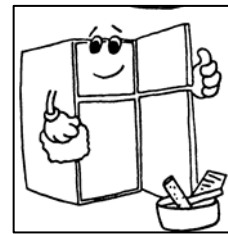

### During first use

- When you first switch on the appliance, the compressor will run continuously for approximately 24 hours or until the fridge freezer reaches a cool enough temperature.
- During this period of time, you should try not to open the door frequently or place a large amount of food within the appliance.
- If the unit is switched off or unplugged, you must allow at least 5 minutes before restarting the appliance on the thermostat or reconnecting it to your mains supply.

## Turning on the appliance and setting the thermostat

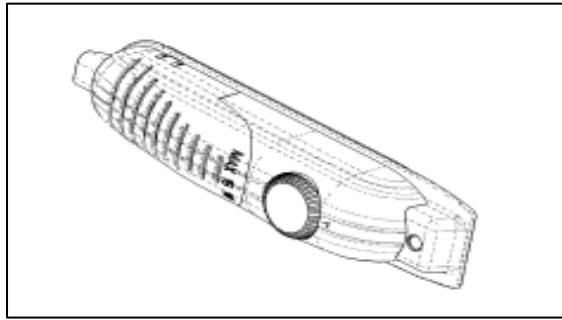

You switch on your appliance by connecting it to your mains supply and setting the thermostat. The thermostat is located on the upper right hand side of the inside of the cabinet, next to the interior light.

- The thermostat automatically regulates the temperature inside the fridge freezer, depending on what number you have turned the thermostat control knob to.
- Position <0> means that the appliance will not cool. However the light will still function.
- Position <1> will give you a higher temperature inside the fridge freezer.
- Position <6> will give you a lower temperature inside the fridge freezer.
- Ideally the thermostat should be set to a position between <3> to <4>.
- The fridge section can maintain a temperature of between 4 – 6 degrees centigrade.
- The freezer section can cool down to -18°C and lower.
- **IMPORTANT:** The ambient temperature of the room, the temperature of food and the amount of food that has been placed in the fridge freezer and how often the door is opened, will all affect the temperature being maintained by the appliance.
- On the maximum setting (position <6>), your fridge freezer will work harder to maintain a lower temperature. There is no need to run your appliance on this setting for prolonged periods and you should return the thermostat knob to between <3> to <4>.

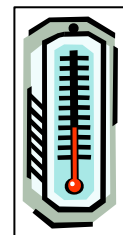

## Arranging and storing food in the fridge section

- Warm food or evaporating liquids should not be stored in your refrigerator, as this will increase the humidity inside of the appliance.
- All foods should be wrapped or covered, this is particularly important if the food has a strong flavour. You should use polythene bags or sheets, aluminium foil, wax paper. Liquids should be stored in covered containers or bottles.
- To maximise the space inside of the fridge section, any excessive packaging on the food should be removed.
- Quickly perishable food should be stored at the back of the refrigerator, which is the coldest part of the appliance.
- No food items should be allowed to come into contact with the back wall of the refrigerator.
- Make sure that you arrange food in such a way that the door can close completely. Particular attention should be given to bottles that may protrude when placed on shelves inside the main section of the refrigerator.
- Some organic solutions, such as the oils in lemon/orange peel and acid in butter, can cause damage to the plastic parts contained inside of the refrigerator.
- Do not open the refrigerator door too often or leave the door open for long periods of time, as this will increase the temperature inside of the appliance.
- **Meat** should be wrapped in polythene bags and then placed on the glass shelf above the salad drawers.  
**(Meat should only be stored in this manner for one or two days at the most).**
- **Cold dishes/cooked food** should be covered and can be placed on any shelf.
- **Fruit and vegetables** should be cleaned thoroughly and placed in the salad drawers.
- **Cheese and butter** should be placed in airtight containers, or they can be wrapped in aluminium foil or polythene bags. As much air as possible should be removed from the bags.
- **Milk bottles** should have a cap on them and be stored on the bottle shelf that sits in the door.
- **Garlic, potatoes, onions and bananas should only be stored in a refrigerator IF they are stored in airtight containers.**

## The freezer compartment

The freezer compartment is suitable for storing and freezing food.

- The freezer compartment temperature must have already reached -18 degrees centigrade (or lower) before you attempt to store food that is already frozen or freezing fresh food.
- The freezer compartment is only able to freeze a certain quantity of food at one time. You should not attempt to freeze more than 6 kilograms of fresh food within a 24 hour period.
- Preferably the top drawer should be used when freezing fresh food. Once the food is frozen, you can then transfer the food to the lower drawers.
- Warm food should be allowed to cool down before you attempt to freeze it. If you place warm food in the freezer compartment, then the increased humidity will cause quicker ice formation and increase the amount of power that the appliance uses.
- The guidance of the food manufacturer should be followed, in regard to the maximum storage time.
- Thawed foods must not be frozen for a second time.

### Freezing fresh food

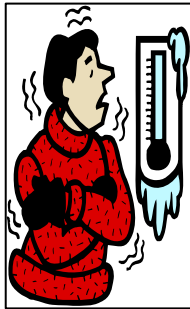

- To freeze the maximum quantity of fresh food specified above, you should turn the thermostat to position <6>, 24 hours prior to attempting freezing.
- For smaller quantities of fresh food, you should turn the thermostat to position <6>, approximately 6 hours prior to attempting freezing.
- Fresh food should be packed into airtight containers or packaging. This will help to make sure that the food doesn't dry out or lose its flavour. It will also ensure that flavour does not transfer from other foods.



- The food should be placed on the freezer compartment's base. Do not allow fresh food to touch items that are already frozen.

- After 24 hours you should check that the fresh food is satisfactorily frozen. If it is then the thermostat should be turned down to its normal setting (between <3> and <4>).

### Tips on freezing

- Freezer bags, polythene wraps, aluminium foil (extra thick) and special cans for frozen foods are suitable packaging for storing frozen goods in.
- Tape, rubber bands or plastic clips are suitable for sealing bags and wrappings.
- Before sealing a suitable bag, you should compress the air out of it, as this will help the food to freeze more easily.
- Flat packages freeze more easily.

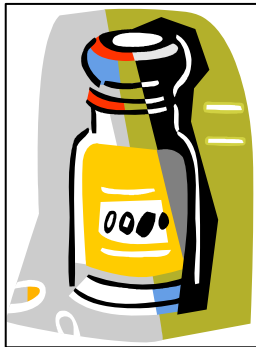
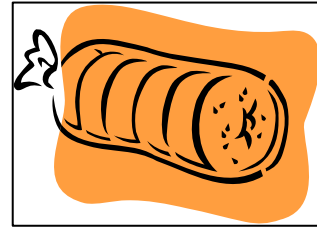

- If you are freezing liquid, then do not fill the container to the brim. Liquids will expand when being frozen.
- **Do not place bottles (glass or tin) containing liquids (especially sparkling liquids) into the freezer as they could cause the bottle to burst during freezing.**

### Making ice cubes

- Fill the ice cube tray with water and place it in the freezer compartment.
- After the water is completely frozen and turned to ice, you can twist the ice cube tray (as shown in the drawing below) to dispense the ice.

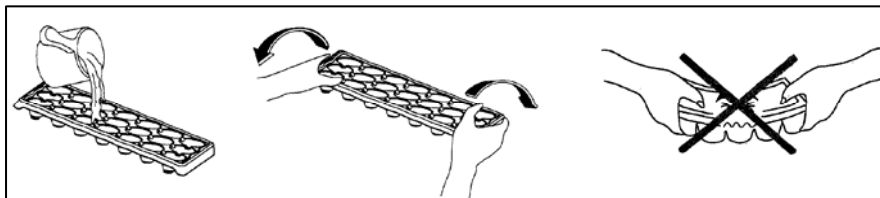

## Cleaning and maintenance

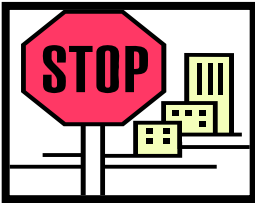

**WARNING: PLEASE ENSURE THAT YOUR APPLIANCE IS DISCONNECTED FROM YOUR MAINS SUPPLY BEFORE ATTEMPTING TO CLEAN IT.**

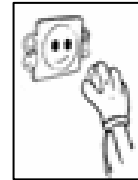

- Do not clean the appliance by pouring water onto it or spraying water over it.



- The refrigerator and freezer compartment should be cleaned periodically, using a solution of bicarbonate of soda and lukewarm water.

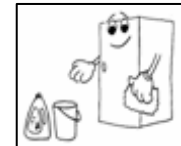

- Clean the accessories separately with soap and water. Do not clean them in a dishwasher.

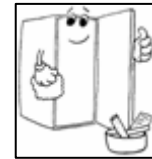

- Do not use abrasive products, detergents or soaps.



- After washing the appliance, wipe over the area that you have cleaned with a damp cloth and then dry it thoroughly.
- When cleaning is complete, dry your hands and then reconnect the plug to your mains supply.

## Defrosting the refrigerator compartment

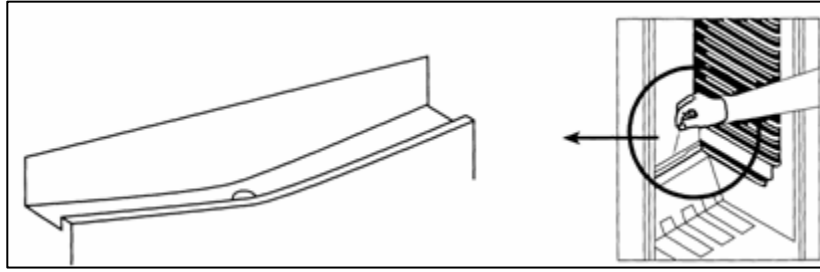

- Defrosting occurs automatically in the refrigerator section during operation. The defrost water is collected by the evaporating tray and evaporates automatically.
- The evaporating tray and defrost water drain hole should be cleaned periodically with the defrost drain plug. This will prevent water from collecting in the bottom of the refrigerator, instead of flowing down the defrost drainage channel and drain hole.
- You can also pour a small amount of water down the drain hole to clean inside of it.
- You should be careful to make sure that food packages do not touch the rear wall of the appliance, as this can interrupt the automatic defrosting process and deflect water into the base of your refrigerator.

## Defrosting the freezer compartment

The frost in the freezer compartment should be removed periodically. You can use a plastic scraper to keep down the amount of frost that builds.

**IMPORTANT:** The freezer compartment should be defrosted at least twice a year. The number of times that you need to defrost it, will depend on the setting of your thermostat and how much food you freeze and store in the compartment.

- The day before you defrost, the thermostat dial to position <5>, this will make sure that the food contained in the compartment is frozen properly.
- Whilst defrosting the appliance, the food should be removed from the compartment and wrapped in several layers of paper and stored in a cool place. The foods rise in temperature will shorten its storage life and therefore the food should be used within a relatively short period of time.



- **DO NOT PLACE FOOD BACK IN THE FREEZER COMPARTMENT THAT HAS STARTED TO THAW.**
- Set the thermostat knob to position <0> and disconnect the appliance from your mains supply.
- Remove the drawers from the freezer section and leave the door to the freezer compartment open. You can place a bowl of warm water inside the freezer compartment to speed up the defrost process.
- You can use a sponge to mop up the defrost water that will run into the bottom of the freezer section.
- **IMPORTANT:** You should place some old towels on the flooring that is immediately in front of the appliance. In case any defrost water comes out of the freezer section and onto the floor.
- Once all the ice that has built up has melted, then the inside of the freezer compartment should be dried thoroughly. Failure to do this will result in immediate ice build when the appliance is turned back on.
- With dry hands, reconnect your appliance to your mains supply. Set the thermostat knob to position <6> for a 24 hour period, before returning it to the normal setting of between <3> and <4>.
- You should not attempt to freeze fresh food inside the freezer compartment until this 24 hour time period has elapsed.
- **Do not defrost the appliance with other electrical devices (e.g. hair dryer). Do not use sharp metal objects to remove the ice on the freezer, as this could cause damage to the refrigerant system.**

## Replacing the light bulb

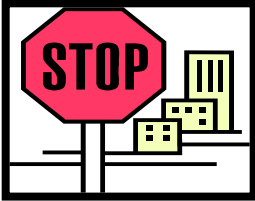

**WARNING: PLEASE ENSURE THAT YOUR APPLIANCE IS DISCONNECTED FROM YOUR MAINS SUPPLY BEFORE ATTEMPTING TO REPLACE THE LIGHT BULB.**

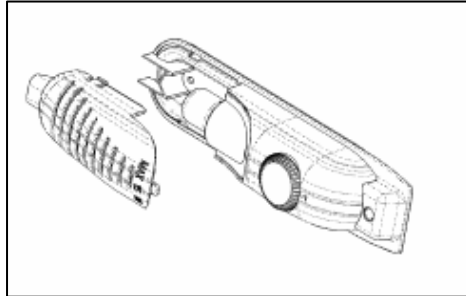
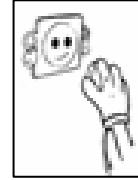

- There is an interior light in the top of the refrigerator section.
- Press the hooks on the sides of the light cover and slide the cover off.
- Change the present light bulb with a new one. The replacement bulb should not have a greater rating than 15 W.
- Replace the light cover and after waiting five minutes, reconnect your plug to your mains supply.

## Installation

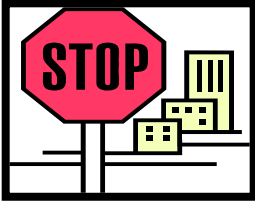

**IMPORTANT: Before installation and usage read all the instructions and make sure that the voltage (V) and the frequency (Hz) indicated on the rating plate are exactly the same as the voltage and frequency in your home. The rating plate can be found on the front left edge of the inside of the refrigerator.**

The manufacturer declines all responsibility in the event of the installer failing to observe all the accident prevention regulations in force, which are necessary for normal use and the regular operation of the electric system.

### Electrical connection



#### **YOUR FRIDGE FREEZER IS INTENDED FOR FITTED AND PERMANENT INSTALLATION.**

We recommend that the appliance is connected by a qualified electrician, who is a member of the N.I.C.E.I.C. and who will comply with the I.E.E. and local regulations.

- Your refrigerator comes supplied with a 13 amp plug fitted. If in future you need to change the fuse in this plug, then a 13 amp ASTA approved (BS 1362) fuse **must** be used.
- The wiring in the mains lead is coloured as follows:

<b>Brown</b>	Live
<b>Blue</b>	Neutral
<b>Green and yellow</b>	Earth
- As the colours of the wires in the appliance's mains lead may not correspond with the coloured markings identifying the terminals in your spur box, please proceed as follows:

The **brown wire** must be connected to the terminal marked "L" (live), or coloured **red**.

The **blue wire** must be connected to the terminal marked "N" (neutral), or coloured **black**.

The **green and yellow wire** must be connected to the terminal marked "E" (earth), or by the earth symbol, or coloured **green and yellow**.

- When the connection is completed, no stray strands or cut wire should be present. The cord clamp must be secured over the outer sheath.

## Positioning

- It is advisable that your appliance is only installed in a location where the ambient temperature of the room, corresponds with the climate classification that is stated on the rating plate of your appliance. Your appliance may not function correctly if the ambient temperature falls outside of the following ranges.

Climate classification	Appropriate ambient temperature
SN	+10 to +32 degrees centigrade
N	+16 to +32 degrees centigrade

- Positioning the appliance requires two persons in order to avoid injuries or damage to the appliance.
- Your appliance should not be located in direct sunlight or exposed to continuous heat or extremes of temperature (e.g. next to a radiator or boiler).
- You should check whether there is an electrical socket available, which will be accessible after your appliance is installed.
- Place the appliance flatly and firmly on a solid base. The appliance is fitted with adjustable feet on the front side, used to level the appliance.
- The rear side of the appliance is fitted with wheels which facilitate the positioning of the appliance into its final location.
- Anything positioned above the appliance must be at least 15 cm away to allow sufficient cooling of the condenser. You must allow a 15mm gap to the rear of the appliance.
- If you are placing another cooling appliance next door to this product, then there must be a gap of at least 2cm between the appliances. This will help to prevent condensation from forming.
- Avoid exposing the appliance to direct sunlight or heat sources. If this is not feasible, then you should install an insulation plate between the appliance and the adjacent heat source.
- Be sure to leave enough space for the opening of the door, to avoid damage to the appliance or personal injury.

## Troubleshooting



**IMPORTANT:** If your fridge freezer appears not to be operating properly, before contacting the Baumatic Service Department, please refer to the checklist below.



**My fridge freezer does not appear to be working/there is no power to my appliance.**

- Check that the plug is fully inserted into the power socket.
- Check that there is power to your mains supply (e.g. that there hasn't been a power cut or that the fuse hasn't blown).
- Check that the thermostat inside the appliance has not been turned to the off position.
- Check that your mains supply voltage, corresponds to the voltage stated on the rating plate of your appliance.



**My fridge freezer appears to be performing poorly**

- Check that the appliance isn't overloaded and that food hasn't been packed too tightly into it.
- The thermostat setting is too low; you should turn the thermostat up higher.
- Ensure that the door is closing properly and that the door has not been opened for a prolonged period in error.
- Ensure that there is adequate ventilation for your appliance.



**My fridge freezer is noisy**

- The refrigerant gas that circulates the pipework of the appliance may make a slight noise, even if the compressor is not running.
- If the noise worsens or the appliance gets louder than normal; check that it is leveled off correctly, that nothing is touching the rear of the fridge freezer and that nothing placed inside the appliance is rattling.



**Ice has formed on the inner back wall of my fridge**

- Check that food has not been pushed too far back inside the appliance, so that it is in contact with the inner back wall.



**There is water in the base of the fridge or leaking out of my fridge.**

- Follow the "Defrosting the refrigerator compartment" section on page 16.

## Baumatic Ltd. Conditions of Guarantee

Dear Customer,

Your new Baumatic appliance comes complete with a free 12 month guarantee covering both parts and labour costs resulting from defective materials or workmanship.

Baumatic also gives you the opportunity to automatically extend the guarantee period for a further 12 months at no extra cost, giving an initial guarantee period of 24 months. The extended guarantee period applies to England, Scotland, Wales and Northern Ireland only.

To qualify for your full 24 months guarantee you **must** register your appliance within 28 days of purchase to be covered under this guarantee. This can be done online via: [www.baumatic.co.uk](http://www.baumatic.co.uk) or through returning the guarantee card which can be found in each new Baumatic appliance.

\* In addition, your appliance is covered by a 5 year parts warranty. Baumatic Ltd will provide free of charge the parts required to repair the appliance, only if they are fitted by a Baumatic engineer, for any defect that arises due to faulty materials or workmanship within a period of 5 years from the original purchase date.

\* An additional 1 to 3 year insurance scheme for labour is available should you wish to extend the warranty period.

Should any person other than an authorised representative of Baumatic Ltd interfere with the appliance, the policy is negated and Baumatic Ltd will be under no further liability.

The guarantee covers the appliance for normal domestic use only, unless otherwise stated.

Any claims made under the terms of the guarantee must be supported by the original invoice/bill of sale issued at the time of purchase.

This guarantee is transferable only with the written consent of Baumatic Ltd.

If the appliance fails and is considered either not repairable or uneconomical to repair during the manufacturer warranty period, a free of charge replacement will not be offered.

The guarantee for any replacement will only be for the remainder of the guarantee on the original product purchased.

The guarantee does not cover:

- Sinks and taps
- Failure to comply with the manufacturers instructions for use.
- The replacement of cosmetic components of accessories
- Accidental damage or wilful abuse.
- Subsequent loss or damage owing to the failure of the appliance or electrical supply
- Incorrect installation
- Losses caused by Acts of God, civil war, failure to obtain spare parts, strikes or lockouts
- Filters, fuses, light bulbs, external hoses, damage to bodywork, paintwork, plastic items, covers, baskets, trays, shelves, burner bases, burner caps, decals, corrosion, rubber seals.

In the course of the work carried out it may be necessary to remove the appliance from its operating position. Whilst all reasonable care will be taken, Baumatic Ltd cannot accept responsibility for damage sustained to any property whatsoever in this process.

This guarantee is in addition to and does not diminish your statutory or legal rights.

Contacting Baumatic Ltd

Sales	Service	Spares	Technical/Advice
TEL: 0118 933 6900	TEL: 0118 933 6911	TEL: 0118 933 6922	0118 933 6933
FAX: 0118 931 0035	FAX: 0118 986 9124	FAX: 0118 933 6942	0118 933 6942

For ROI (Republic of Ireland), please contact one of the numbers below:

TEL: 01 – 6266798                      FAX: 01 - 6266634

Thanks you for buying Baumatic.

\* Applies to UK, Scotland, Wales & Northern Ireland only (Republic of Ireland has 1 year labour & 1 year parts warranty only)

# Baumatic Ltd

*You will be mine*

## **Headquarters**

Baumatic Ltd.  
Baumatic Buildings,  
6 Bennet Road,  
Reading,  
Berkshire  
RG2 0QX, United Kingdom

Sales Telephone  
+44 118 933 6900

Sales Fax  
+44 118 931 0035

Service Telephone  
+44 118 933 6911

Service Fax  
+44 118 986 9124

Spares Telephone  
+44 118 933 6922

Technical / Advice Telephone  
+44 118 933 6933

## **E-mail:**

[sales@baumatic.co.uk](mailto:sales@baumatic.co.uk)

[technical@baumatic.co.uk](mailto:technical@baumatic.co.uk)

Http (Internet site):  
[www.baumatic.com](http://www.baumatic.com)



**Baumatic®**

[www.baumatic.com](http://www.baumatic.com)