

**STD6.2SS-W 60 cm
Standard hood**

INSTRUCTION MANUAL

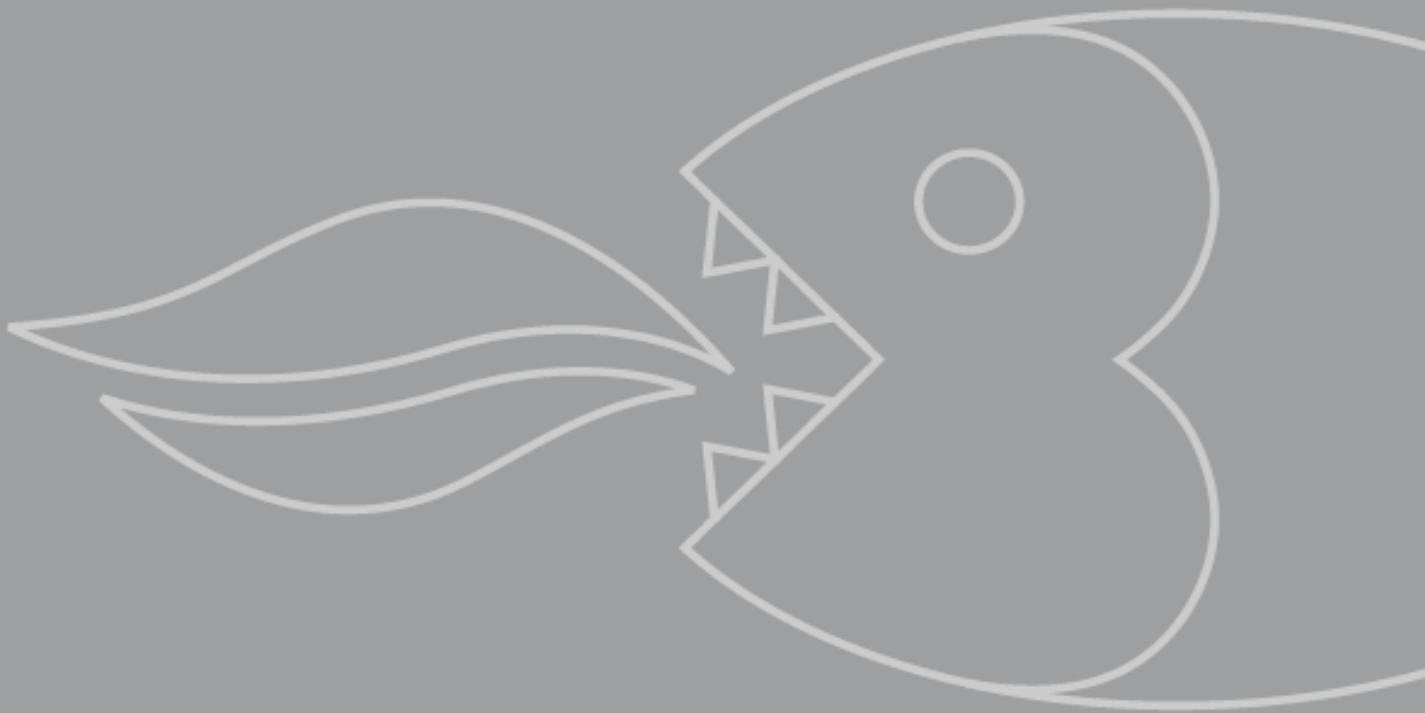

User Manual for your Baumatic

STD6.2SS-W 60 cm Standard Hood



NOTE: This User Instruction Manual contains important information, including safety & installation points, which will enable you to get the most out of your appliance. Please keep it in a safe place so that it is easily available for future reference; for you or any person not familiar with the operation of the appliance.

GS 09/09/10

Environmental note	4
IMPORTANT SAFETY INFORMATION	5 – 7
Specifications of your cooker hood	8
Using your Baumatic cooker hood	9 - 10
Before first use	9
To use your cooker hood	9 - 10
Cleaning your Baumatic cooker hood	10 – 11
The grease filter	11
Maintenance	12 – 14
Removing and cleaning the grease filters	12
Changing a light bulb	13
Fitting the carbon filters	14
Installation	15 - 20
Electrical connection	15 - 16
Before beginning installation	16 - 17
Installing your cooker hood	17 - 19
Connecting to external ducting	19 - 20
Completing the installation	20
Extraction mode or recirculation mode?	21
Troubleshooting	22 - 23
Contact details	24

ENVIRONMENTAL NOTE

Note: Before discarding an old appliance, switch off and disconnect it from the power supply. Cut off and render any plug useless. Cut the cable off directly behind the appliance to prevent misuse. This should be undertaken by a competent person.

This appliance is marked according to the European directive 2002/96/EC on Waste electrical and Electronic Equipment (WEEE). By ensuring this product is disposed of correctly, you will help prevent potential negative consequences for the environment and human health, which could otherwise be caused by inappropriate waste handling of this product.

The symbol  on the product, or on the documents accompanying the product, indicates that this appliance may not be treated as household waste. Instead it shall be handed over to the applicable collection point for the recycling of electrical and electronic equipment.

Disposal must be carried out in accordance with local environmental regulations for waste disposal.

For more detailed information about treatment, recovery and recycling of this product, please contact your local city office, your household waste disposal service or the shop where you purchased the product.



- The packaging materials that Baumatic uses are environmentally friendly and can be recycled.
- Please discard all packaging material with due regard for the environment.

IMPORTANT SAFETY INFORMATION



Your safety is of the utmost importance to Baumatic. Please make sure that you read this instruction booklet **before** attempting to install or use the appliance. If you are unsure of any of the information contained in this booklet, please contact the Baumatic Advice Line.

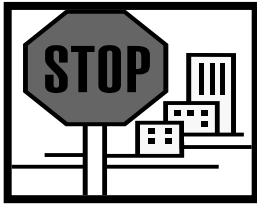

IMPORTANT: Any installation work must be carried out by a qualified electrician or competent person.

- The hood must be installed in accordance with the installation instructions and all measurements followed.
- If the cooker hood is installed for use above a gas appliance then the provision for ventilation must be in accordance with the Gas Safety Codes of Practice BS.6172, BS.5440 & BS.6891 (Natural Gas) and BS.5482 (LP Gas) 1994, the Gas Safety (Installation & Use) Regulations, the Building Regulations issued by the Department of the Environment, the Building Standards (Scotland) (Consolidated) Regulations issued by the Scottish Development Department.
- It is dangerous to alter the specifications or to modify this product. Do not tamper with it or attempt to modify the appliance in any way.
- When installing the hood, ensure that the following recommended distances are observed between the highest point on the hob top (including the burners) and the bottom of the cooker hood:

- **Electric cookers:** 700 mm
- **Gas cookers:** 700 mm
- **Coal/ oil cookers:** 800 mm



IMPORTANT: DO NOT SET YOUR COOKER HOOD LESS THAN 700mm ABOVE YOUR COOKER.

- When installed between adjoining wall cabinets, the cabinets must not overhang the hob.

- The edges of the cooker hood are sharp – be mindful of this as you handle your appliance, especially during installation and cleaning. **DO NOT CLEAN IN BEHIND THE GREASE FILTERS!**
- If the room where the cooker hood is to be used contains a fuel burning appliance such as a central heating boiler then its flue must be of the sealed or balanced flue type.
- If other types of flue or appliances are fitted, ensure that there is an adequate supply of air in the room.
- When the hood is being used in its extractor function, ensure that the ducting is fire retardant and that there are no bends sharper than 90 degrees as this will reduce the efficiency of the hood.
- Ensure the ducting for the extractor function has the same diameter as the outlet hole all the way through.
- Keep young children from using, playing with or tampering with the cooker hood. Older children and infirm persons should be supervised if they are using the cooker hood.



- Your cooker hood is for domestic use only.



- Please dispose of the packing material carefully – children are especially vulnerable to it.

- Dirty oil is an even greater fire risk.



- Always put lids on pots and pans when cooking on a gas cooker.

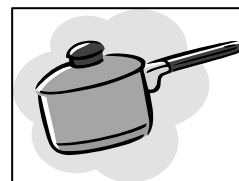

- The manufacturer refuses to accept any responsibility for damages arising to the hood or it catching on fire, from a failure to observe the fire safety advice contained in this instruction booklet.

- Remember that when in extraction mode, your cooker hood is removing air from your room. Ensure that proper ventilation measures are being observed.
- **Note that it removes odours from your room, not steam.**
- **Warning - Always ensure that the cooker hood has been disconnected from the power supply before carrying out any work on the hood, including replacing light bulbs.**

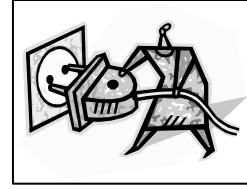

- Do not connect the ducting system of this appliance to any existing ventilation system which is being used for any other purpose.
- Do not install above a cooker with a high level grill.

- Never leave frying pans unattended during use as overheated fats and oils might catch fire.



- The cooker hood should not be exposed to a direct heat source from the cooking device underneath it, i.e. naked flame from a gas burner or heat from electric hob zones **without** a pan on them.
- Do not attempt to use the cooker hood if it is damaged in any way. Never attempt to use it without the grease filters fitted or if the filters are excessively greasy!
- Never flambé cook under this cooker hood.
- The lights on this appliance should only be used during operation of the cooker hood. They should not be left on permanently and used as a lighting source.

THE MANUFACTURER DECLINES ALL RESPONSIBILITY IN THE EVENT OF FAILURE TO OBSERVE THE INSTRUCTIONS GIVEN HERE, FOR INSTALLATION, MAINTENANCE AND SUITABLE USE OF THE HOOD.



Specifications of your cooker hood

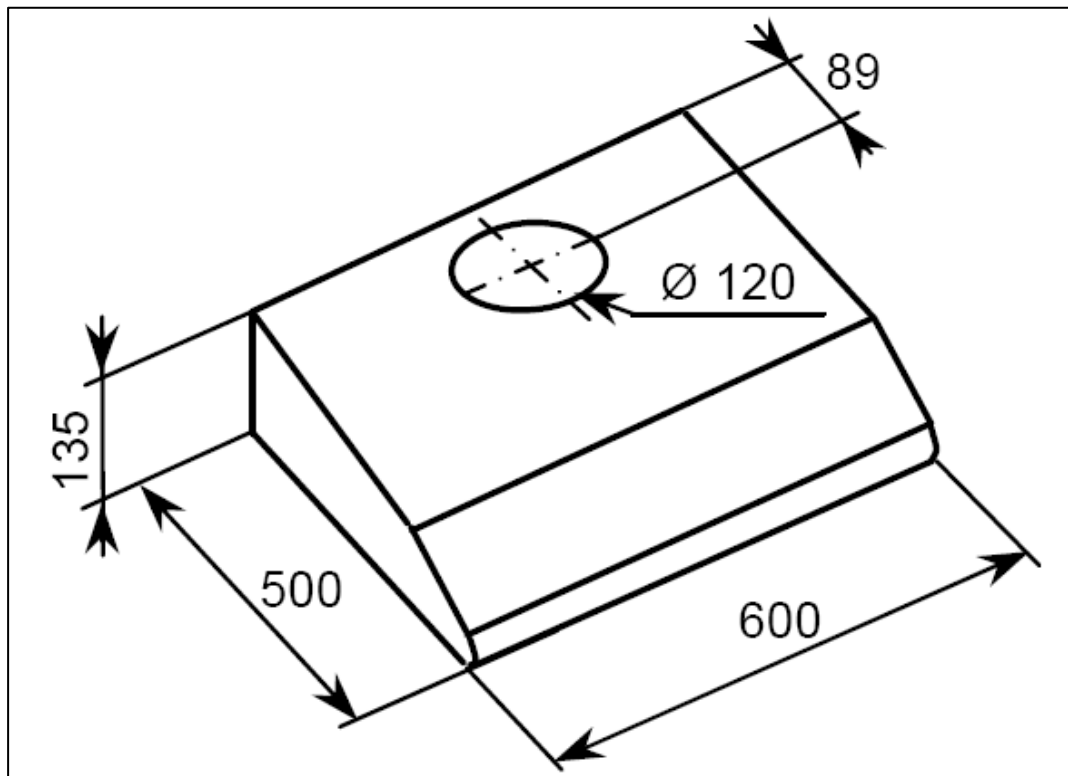

PRODUCT DIMENSIONS

Height: 135 mm
Width: 600 mm
Depth: 500 mm

APERTURE DIMENSIONS

Width: 600 mm
Depth: 370 mm (min)

Your cooker hood is fitted with:

- Slider control operation
- 3 x speeds
- 1 x washable grease filter grill
- 1 x light

Extraction capacity: 180 m³/hr

Optional extras: 1 x SF11 Acrylate filter for air recirculation mode

DK5 1 Metre length Ducting Kit 125 mm Ø

DK10 3 Metre length Ducting Kit 125 mm Ø with flat channelling included



All of the optional extras are available from the Baumatic Spares Department.

Using your Baumatic cooker hood

Before first use



IMPORTANT: THIS PROCESS MUST BE FOLLOWED BEFORE THE COOKER HOOD IS USED FOR THE FIRST TIME.

STD6.2SS

- You should use a good quality stainless steel cleaner on ALL of the stainless steel areas of your cooker hood, before it is used for the first time.
- This will help to leave a silicone water-resistant film to protect the stainless steel surfaces.

STD6.2W

- You should use a mild liquid detergent and a damp cloth on all the external areas of your cooker hood, before it is used for the first time.
- This will help to remove any residues from the manufacturing process.

To use your cooker hood

- Make sure that it has been installed by a suitably qualified person, as per the information contained in Baumatic's installation instructions.
- Find the control panel, which is located at the front right of the canopy.
- The control panel contains switches, as shown in the picture below, which perform separate functions.

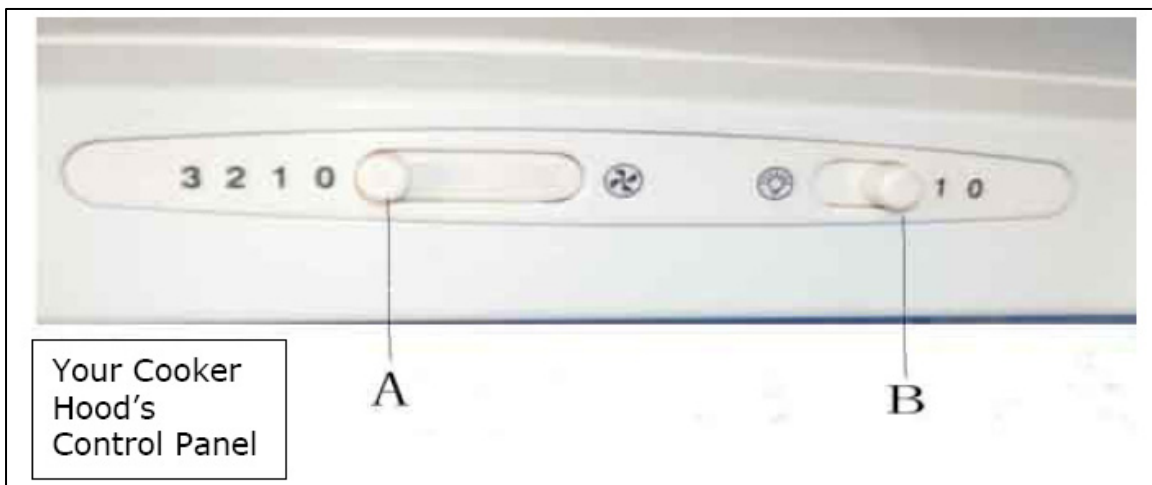

A = Motor ON / OFF switch. This switch turns the motor on and off and adjusts its speed. There are three speed sheets and pushing the switch to the right increases the speed.

B = Light ON / OFF switch. This switch turns your cooker hood's light on and off.



IMPORTANT: IDEALLY YOU SHOULD SWITCH ON YOUR HOOD TEN MINUTES BEFORE YOU START TO COOK, OR AT THE VERY LEAST WHEN YOU BEGIN COOKING. YOU SHOULD ALSO RUN YOUR HOOD FOR TEN MINUTES AFTER YOU HAVE FINISHED COOKING.

Cleaning your cooker hood

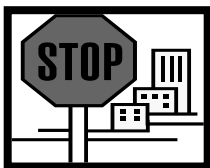

IMPORTANT: BEFORE CLEANING, ALWAYS ENSURE THAT YOU HAVE SWITCHED YOUR COOKER HOOD OFF AT THE OMNI-POLAR SWITCH, SET AT THE WALL FROM THE CABLE.

Cleaning

- Clean the external parts of your cooker hood with mild liquid detergent and a new damp cloth.
- Never use abrasive powder, corrosive solvents or brushes.
- Never insert pointed objects into the motor's protective grid.
- Only clean the control panel and grease filter grill with mild liquid detergents and a new damp cloth.

- If you are using the appliance in recirculation mode, then be sure to replace the carbon filters at the recommended interval (see section on “Fitting the carbon filter”). A build up of grease could cause a fire hazard.
- Never attempt to clean the area above the grease filter.
- ***IMPORTANT (STD6.2SS): You should regularly use a good quality stainless steel cleaner to maintain the shine and finish on the stainless steel areas of your cooker hood. This will help to leave a silicone water-resistant film to protect the stainless steel surfaces and keep them in good condition for the life of the product.***

The grease filter

- Your cooker hood includes a grease filter which helps to absorb grease particles to protect your kitchen & furniture from greasy residues.
- Your cooker hood includes a metal filter which can be periodically washed and a paper filter which will need to be replaced on a regular basis.
- These filters may become flammable if they become saturated with greasy residue.
- To prevent this fire hazard, the metal filter should be cleaned and the paper filter replaced regularly. Depending on use, this should be done every two months, using hot water and normal washing-up detergent.
- ***DO NOT WASH THE GREASE FILTER IN A DISHWASHER.***

Maintenance

Removing and cleaning the metal filter

- First remove the metal filter by sliding the securing nibs at the sides of the grille on the underside of the cooker hood.
- A paper filter is located above the metal filter. This should be discarded and replaced with a new one.

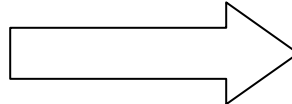
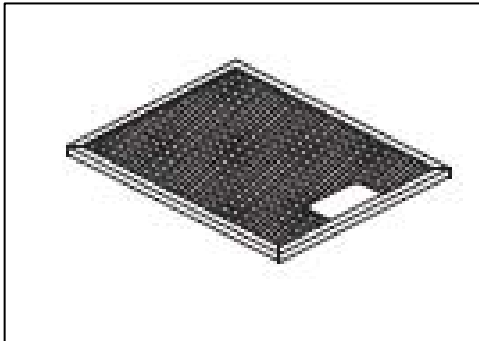

- Soak the metal filter in hot water and washing up liquid for about an hour.
- Rinse it off thoroughly with hot water.
- Repeat the process if required.
- Replace the paper filter above the metal filter and refit to the cooker hood once the metal filter has dried.
- ***IMPORTANT: Let the grease filter dry thoroughly before refitting it in the cooker hood.***
- ***Never attempt to use your cooker hood without the grease filter in place.***

Changing a light bulb

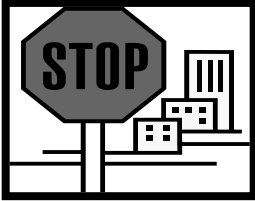

IMPORTANT: BEFORE ATTEMPTING TO CHANGE A LIGHT BULB, YOU MUST ENSURE THAT YOU HAVE DISCONNECTED THE COOKER HOOD FROM YOUR MAINS SUPPLY.

- Remove the metal filter by sliding the securing nibs at the sides of the grill on the underside of the cooker hood.
- Undo the screw that holds the plastic cover in place and remove it.
- Prior to touching the light bulb, ensure that it has cooled down.
- Replace the bulb using ***only*** olive-shaped spares with an E14 coupling, max. 40W. Replace the grease filter support grille.
- ***IMPORTANT: Defective bulbs should be replaced immediately.***
- If the lights still do not work, make sure that the bulbs are fitted properly into their housings before you call for technical assistance.
- Refit the plastic cover and metal filter.

Fitting the carbon filter

If the appliance is going to be used in recirculation mode then it is necessary to fit a carbon filter. This will help to absorb unpleasant odours caused by cooking.

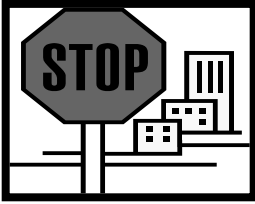

IMPORTANT: BEFORE ATTEMPTING TO FIT OR REMOVE THE CARBON FILTERS, YOU MUST ENSURE THAT YOU HAVE DISCONNECTED THE COOKER HOOD FROM YOUR MAINS SUPPLY.

- 1) Remove the metal filter by sliding the securing nibs at the sides of the grill on the underside of the cooker hood.
- 2) Place the acrylate carbon filter above the metal and paper grease filters.

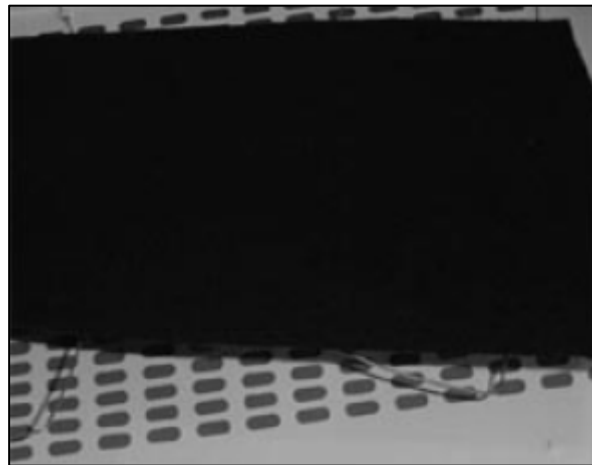

- 3) Use the small steel wire to press the acrylate carbon filter into place. Make sure the acrylate carbon filter is fitted neatly and securely and cannot be removed.
- 4) Replace the grease filter.

Installation

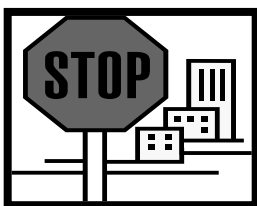

IMPORTANT: Before installation read all the instructions and make sure that the voltage (V) and the frequency (Hz) indicated on the rating plate are exactly the same as the voltage and frequency in your home. The rating plate can be found behind the grease filters.

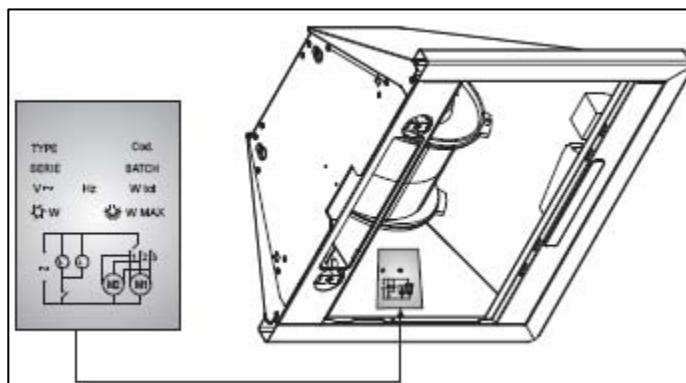

The manufacturer declines all responsibility in the event of the installer failing to observe all the accident prevention regulations in force, which are necessary for normal use and the regular operation of the electric system.

Electrical connection

YOUR COOKER HOOD IS INTENDED FOR FITTED AND PERMANENT INSTALLATION.



- If not supplied the power cable must be connected to the terminals marked L (live) and N (neutral) in the hood and fixed with a cable clamp.
- The cooker hood's power cable must be fitted upstream from the electrical connection, using an omni-polar switch with a contact distance of at least 3 mm.

WARNING: THIS APPLIANCE MUST NOT BE EARTHED. It should only be connected by a competent person, using fixed wiring via a double pole switched fused spur outlet **OR** connected using a 13 AMP plug with a 3 AMP fuse fitted.



We recommend that the appliance is connected by a qualified electrician, who is a member of the N.I.C.E.I.C. and who will comply with the I.E.E. and local regulations. The wires in the mains lead are coloured in accordance with the following UK code:

Blue = Neutral

Brown = Live

You will only find two wires in the main's lead (blue and brown) which means neither must be connected to the earth terminal.

- As the colours of the wires in the appliance's mains lead may not correspond with the coloured markings identifying the terminals in your spur box, please proceed as follows:

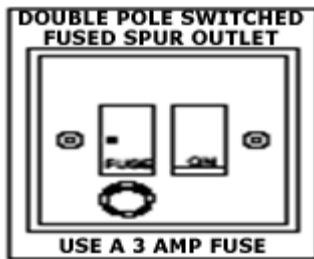

- The **blue wire** must be connected to the terminal marked "N" (neutral), or coloured **black**.
- The **brown wire** must be connected to the terminal marked "L" (live), or coloured **red**.

Before beginning installation

- Check that the product purchased is of a suitable size for the chosen installation area. In addition check whether there is an electrical socket available that will be accessible once the hood is mounted. If the product is going to be used in extraction mode, then there should also be space to connect a ducting hose to the outside.
- Carry out all necessary masonry work prior to the fitting of the cooker hood.
- Ensure that all electrical connections are carried out by a suitably qualified person.
- Before commencing installation of the cooker hood the grease filters should be removed.
- Check inside the product and ensure that there is no transit packaging or any other materials, such as packets of screws, guarantees etc. These should be removed and kept for future use.

- If possible, disconnect and move freestanding or slot-in cookers from their position, to provide easier access to the rear wall and ceiling. If this is not possible, then a thick, protective covering should be placed over the worktop, hob top or cooker. This will help to protect these surfaces from damage and debris.
- Select a flat surface for assembling the cooker hood. Cover that surface with a protective covering and place all cooker hood parts and fittings on it.
- Do not tile, grout or silicone this appliance to the wall or cabinetry. This appliance is designed to be surface mounted only.

Installing your cooker hood



IMPORTANT: YOU WILL HAVE TO DECIDE BEFORE INSTALLING YOUR COOKER HOOD WHETHER TO USE IT IN EXTRACTION MODE OR RECIRCULATION MODE. PLEASE TURN TO PAGE 20 NOW TO UNDERSTAND THE DIFFERENCES BETWEEN THESE TWO MODES.

- We recommend that at two people install this hood.
- Your cooker hood can be fitted to the wall or to the underside of a kitchen cabinet.
- It must be positioned at least 700 mm above the hob underneath it. You cannot fit this product by securing it between two cupboards.

IMPORTANT: YOUR COOKER HOOD SHOULD BE CONNECTED TO YOUR MAINS SUPPLY AFTER THE REST OF THE INSTALLATION PROCESS HAS BEEN COMPLETED.

Wall installation

NOTE: All the screws mentioned in this section come with your cooker hood.

- 1) Position the hood against the wall and mark the positions for the supporting bracket bolt holes of the exhaust hole (this hole must be 130 mm in diameter).

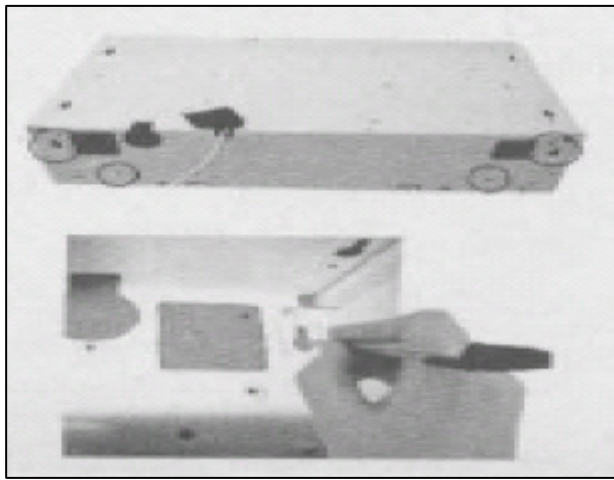

- 2) Drill these holes into the wall using a 6 mm diameter drill bit. If you intend to use your cooker hood as an extraction fan, you will need to fit a ducting kit through this that will connect to your appliance.
- 3) Insert the rawlplugs into the holes and then insert the top screws part way, so that the screws stick out by 10 mm.
- 4) Hang the hood up on the screws. Insert the bottom screws.
- 5) Tighten the screws the rest of the way in.
- 6) For the **extraction function**, connect the exhaust outlet pipe to the collar strip. Find the screw holes on the top of the cooker hood. Tighten the bolts from inside the hood.

Installation into the underside of a kitchen cabinet

- 1) **Extraction function only:** Cut a hole measuring 130 mm in diameter in the external wall behind the cupboard into which the hood will be set and then attach one end of the ducting hose to it. The other end should be connected to the top of the cooker hood.
- 2) If necessary, make a hole for the power cable to feed through.
- 3) Hold the hood against the underside of the hood and mark the points for the supporting and fastening holes.
- 4) Screw in the four screws supplied with the installation accessory kit.
- 5) Hook the hood onto the supporting screws and tighten them completely.

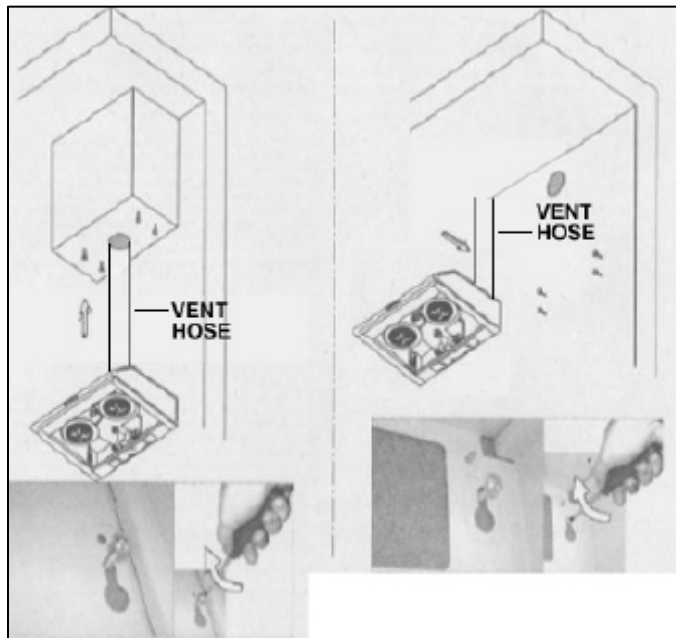

6) Close the grease filter grille.

IMPORTANT: *If you are going to connect your cooker hood to external ducting, the vent hose can ONLY be connected to the top of the cooker hood. There is no rear venting position.*

Connecting to external ducting

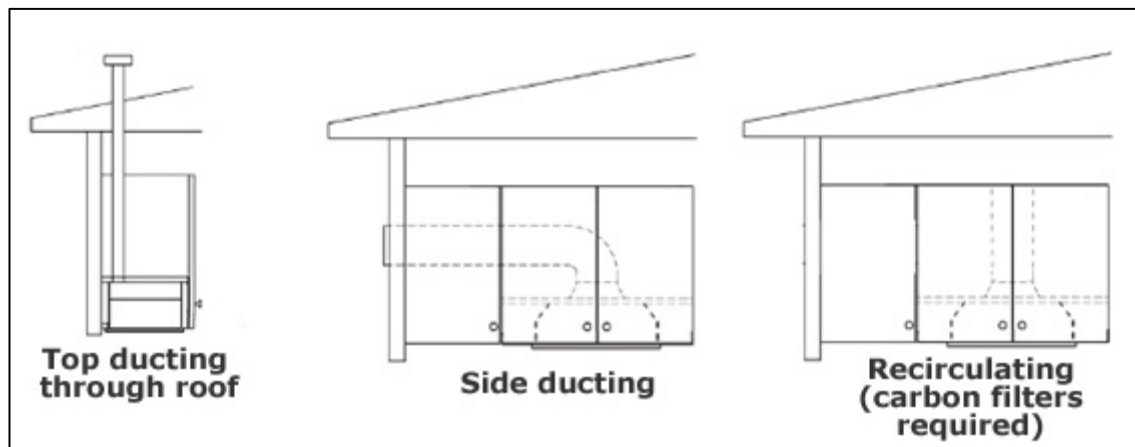

- Connect the coupling to the top of the cooker hood, using two of the smaller screws provided.
- Connect a 125 mm ducting hose to a discharge outlet that is suitable for cooking vapours.
- The discharge outlet should have a cross section of at least 150 cm² (please note that the ducting hose is not supplied with the appliance but one can be obtained from the Baumatic Spares Department).

- The maximum distance between the coupling and your discharge outlet should be 3 metres, with one 90 degree bend. For each additional 90 degree bend, the maximum distance is reduced by a further metre.
- Before fixing the cooker hood into the kitchen unit, you should connect the other end of the ducting hose to the coupling in the top of the cooker hood.

Completing the installation

If you are setting the appliance to recirculation mode, then you should now fit the two carbon filters. See the “Fitting the carbon filter” section on pages 14.

The electrical connection must correspond to the electrical requirement noted on the rating plate, which is placed inside the cooker hood. The appliance should now be connected to the electrical supply. See pages 15-16 for detailed information on the electrical connection.



Refit the metal filter (complete with paper filter) and then switch on the mains supply to the appliance. Check that the appliance is operating correctly by selecting each speed and switching the light bulb on and off.

Extraction mode or recirculation mode?



IMPORTANT: YOU WILL HAVE TO DECIDE BEFORE INSTALLING YOUR COOKER HOOD WHETHER TO USE IT IN EXTRACTION MODE OR RECIRCULATION MODE.

What is the difference between extraction and recirculation modes?

In extraction mode, the stale air will be taken via the grease filter and out of the room via external ducting.

In recirculation mode stale air is taken via the grease filter, and passed through a charcoal filter for purification. The air then re-enters the kitchen via an opening in the hood.

For optimum performance, we recommend that the cooker hood is used in extraction mode and connected to external ducting.

Unfortunately if you live in a flat or the hood is too far from an outside wall, this may not be possible. The only alternative is to recirculate the air.

Do I need a charcoal filter?

All cooker hoods have a grease filter but if you are using your cooker hood in recirculation mode, then a charcoal filters must be fitted in addition to the grease filter.

Troubleshooting

IMPORTANT: If your cooker hood appears not to be operating properly, before contacting the Customer Care Department, please refer to the checklist below.



My cooker hood will not start.

- Check that the hood is connected to the power supply and whether you have selected any of the fan speeds.



My cooker hood is not working effectively.

- Check that fan speed is set to an appropriate setting.
- Check that the grease filters are not dirty and if it requires cleaning.
- If the hood is set up for recirculation mode, check that the carbon filter does not need to be replaced.
- If the hood is set up for extraction mode, check that the ducting hose and discharge outlet are not blocked.



My cooker hood is noisy and/or vibrating.

- Check whether the installation has been completed as per the instruction booklet.
- It is normal to get a certain amount of noise and vibration, due to the extraction capacity of the cooker hood.

DO NOT MAKE ANY ATTEMPT TO REPAIR THE APPLIANCE YOURSELF. IF THE APPLIANCE IS STILL NOT OPERATING CORRECTLY, PLEASE CONTACT THE CUSTOMER CARE DEPARTMENT ON TELEPHONE NUMBER (0118) 933 6911.

My appliance isn't working correctly



IMPORTANT: If your appliance appears not to be operating correctly, then you should disconnect it from your mains supply and then contact Baumatic Customer Care on telephone number (0118) 933 6911.

DO NOT ATTEMPT TO REPAIR THE APPLIANCE YOURSELF.

Please note that if an engineer is asked to attend whilst the product is under guarantee and finds that the problem is not the result of an appliance fault, then you may be liable for the cost of the call out charge.

The appliance must be accessible for the engineer to perform any necessary repair. If your appliance is installed in such a way that an engineer is concerned that damage will be caused to the appliance or your kitchen, then he will not complete a repair.

This includes situations where appliances have been tiled in, sealed in with sealant, have wooden obstructions placed in front of the appliance, like plinths. Or any installation other than the one specified by Baumatic Ltd. has been completed.

Please refer to the conditions of guarantee that appear on the warranty card that you receive with the appliance.

IMPORTANT: Baumatic Ltd. operates a policy of continuous improvement and reserves the right to adjust and modify its products without prior notification.



United Kingdom

Baumatic Ltd.,
Baumatic Buildings,
6 Bennet Road,
Reading, Berkshire
RG2 0QX
United Kingdom

Sales Telephone

(0118) 933 6900

Sales Fax

(0118) 931 0035

Customer Care Telephone

(0118) 933 6911

Customer Care Fax

(0118) 986 9124

Spares Telephone

(01235) 437244

Advice Line Telephone

(0118) 933 6933

E-mail:

sales@baumatic.co.uk
customercare@baumatic.co.uk
spares@baumatic.co.uk
technical@baumatic.co.uk

Website:

www.baumatic.co.uk

Republic of Ireland

Service Telephone

1-890 812 724

Spares Telephone

091 756 771

Czech Republic

Baumatic CR spol s.r.o.
Průmyslová zóna Sever 696
460 11 Liberec 11
Czech Republic

+420 483 577 200

www.baumatic.cz

Slovakia

Baumatic Slovakia, s.r.o.
Galvániho 7/D
Slovakia

+421 255 640 618

Germany

Baumatic GmbH
Lilienthalstrasse 1
320 52 Herford
Deutschland

+49 5221 694 99-0

www.baumatic.de

Italy

Baumatic Italia S.R.L.
Via Galvani N.3
35011 Campodarsego (PD)

+3904 9920 2297

www.baumatic.it

Holland

Baumatic Benelux B.V.
Grindzuigerstraat 22
1333 MS ALMERE
Nederland

+3136 549 1555

www.baumatic.nl

