

Thermostatic Tubular Heaters

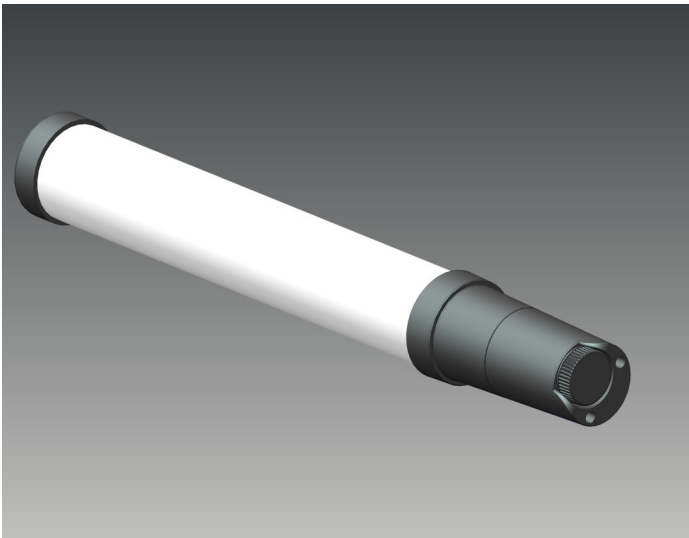

Product Description

Low output, adjustable heat source suitable for a huge range of applications, from airing cupboards to shop windows and greenhouses.

Key Features

- Full range of 6 sizes/outputs
- Discreet mounting brackets for walls or floors
- Reversible left or right hand cable entry
- IPX4 rated
- Even heat distribution across heater body

Technical Details

Power Controls	Adjustable thermostat allowing frost protection and output selection
Thermostat Controls	Rotary control
Cable	1.5m fitted with plug
Thermostat	Bimetallic
Thermal Cut out	Automatic reset
Element	Coiled type
Colour/ Finish	White / grey
IP Rating	IPX4
Approvals	CE
Warranty	1 year

Dimensions

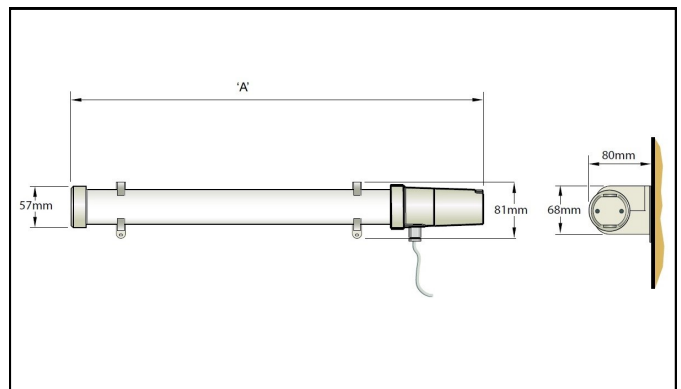

Model No.	Loading W	Height mm	Length mm (A)	Depth mm	Weight kg
ECOT1FT	40	81	408	80	0.5
ECOT2FT	80	81	713	80	0.6
ECOT3FT	120	81	960	80	.8
ECOT4FT	160	81	1323	80	1
ECOT5FT	200	81	1570	80	1.1
ECOT6FT	240	81	1933	80	1.3

Packaging Details

Model No.	Length mm	Height mm	Depth mm	Barcode
ECOT1FT	515	90	65	5011139049667
ECOT2FT	820	90	65	5011139049674
ECOT3FT	1125	90	65	5011139049681
ECOT4FT	1430	90	65	5011139049698
ECOT5FT	1735	90	69	5011139049704
ECOT6FT	2030	94	69	5011139049711

Additional Information

The maximum surface temperature of these units is 85 degrees celsius rise over ambient.