

GuardCam ^{LED}®

Combined security camera LED floodlight system



esp

www.espuk.com

IMPORTANT NOTES - PLEASE READ

The requirement to install back up batteries has now been removed from the latest version of GuardCam. Time and date settings will now be maintained during mains power outages for a minimum of 72 hours.

The minimum requirements of a PC / Laptop required to provide accurate reading and re-writing of an SD card used within the GuardCam is as follows:

CPU	Minimum 1GB
RAM	Minimum 2GB
OS	Windows 2000 / XP / Vista / 7
SD card	Must have a capacity of 2GB or higher (maximum 32GB)

Formatting the SD card

- It is good practice to Format the SD card using the PC / Laptop you intend to use for viewing captured images each time any of the following events occur
- After a mains power removal from the GuardCam
- When changing the selected image capture option from Video to photo
- When changing the selected image capture option from photo to video
- After removing the SD card for viewing prior to replacing in the GuardCam

To format the SD card

Please ensure to save any required images to an alternative folder prior to formatting.

- Place it in the SD / USB adaptor supplied
- Place the adaptor in a spare USB port on your PC / Laptop
- Right click on the SD card location
- Select Format
- Ensure the correct file system is selected FAT16 (or FAT) for SD and FAT32 for SDHC
- Ensure the Quick Format option is NOT selected
- Select "Start"

Following these simple points will ensure correct operation of GuardCam and should be considered as part of its maintenance schedule.

Table of contents

Contents of package	3
GuardCam LED Motion Light with Video Camera	4
Step 1 - Insert/remove SD Card	4
Step 2 - Installing the GuardCam LED	5
Step 3 - Mounting the GuardCam LED	6
Step 4 - Adjusting the settings	7
Step 5 - Setting the Date and Time and Video Mode	9
Step 6 - Viewing Video	10
Technical Specifications	11
General Information and Safety	12

Contents of package



GuardCam LED Motion Light with Video Camera



User Manual



SD USB card reader



1 x Allen key
2 x screws
2 x plastic masonry plugs



2G SD card and

GuardCam LED Motion Light with Video Camera

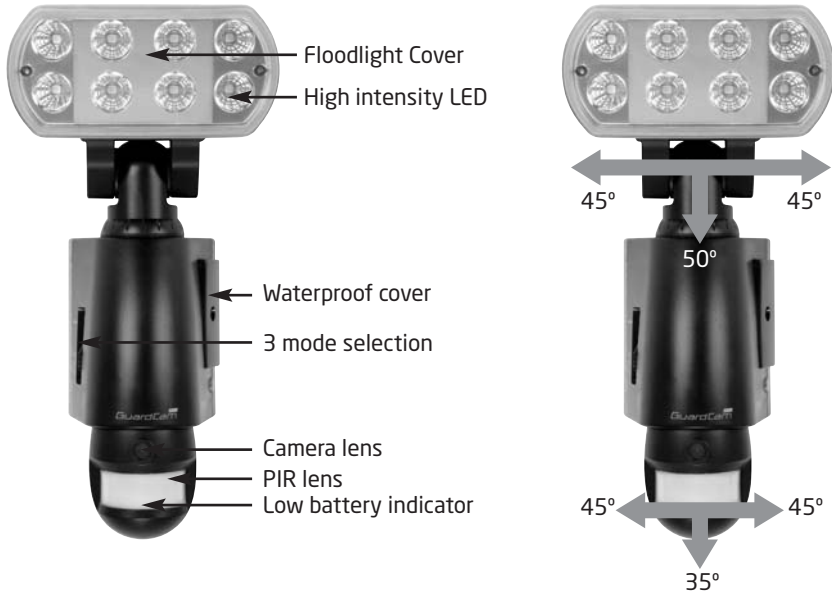

Step 1 - Insert/remove SD card

- Unscrew the waterproofed cover using provided Allen key, then insert the SD card until it automatically locks into place.
- If you need to remove the SD card, please press OFF button and take it out within 30 seconds.
- When LED light turns green, meaning SD card is being read, do not remove SD card or data may be lost.
- To remove SD card, push in SD card to eject. Once to unlock then pull out.

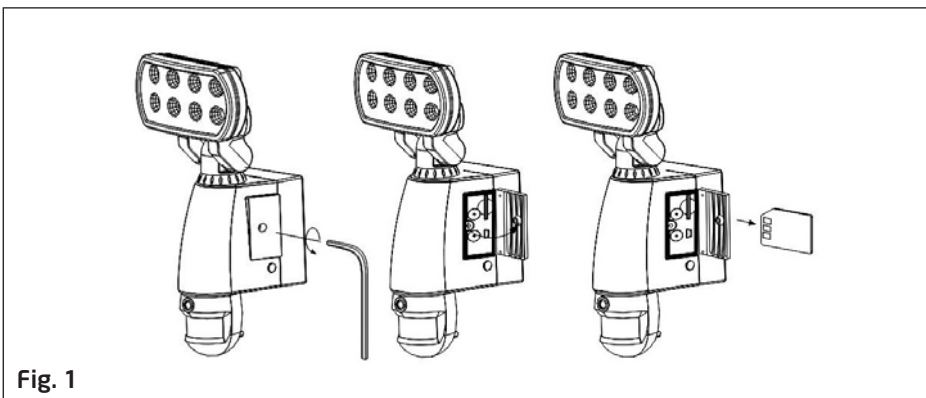

Step 2 - Installing the GuardCam LED

IMPORTANT - IF IN ANY DOUBT ABOUT THE INSTALLATION OF THIS PRODUCT, CONSULT A QUALIFIED ELECTRICIAN

- This product must be earthed
- Do not mount the unit against inflammable surfaces
- The motion detector will not operate correctly if it is installed:
 - Near the outlet of a central heating boiler
 - Near air conditioning plant
 - Pointing directly at moving vehicles
 - Within sight of reflections from moving water
 - Where other lamps could shine on the detector

BEFORE ATTEMPTING ANY INSTALLATION OR MAINTENANCE, ENSURE THAT THE ELECTRICAL SUPPLY IS SWITCHED OFF AND THE CIRCUIT FUSES REMOVED OR THE CIRCUIT BREAKER IS IN THE OFF POSITION.

Please make sure the voltage and polarity are correct before connection. Incorrect voltage may cause electric shock. If you are not sure, please contact your retailer.

Note: It is recommend to mount GuardCam LED 2M above the ground for optimum performance, do not mount the fixture below 1.2M.

See Fig. 3 for details of performance range.

Detection range: 10M x 160° (see Fig. 2)

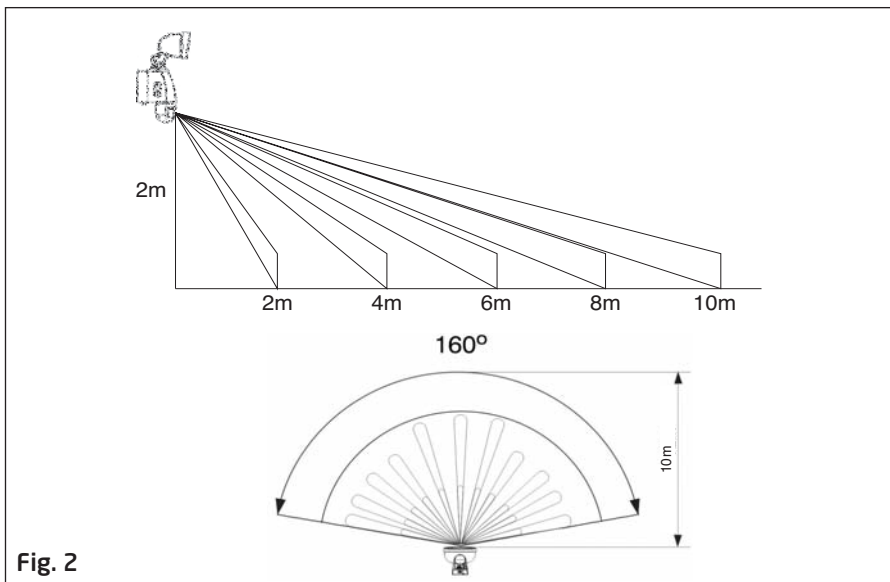
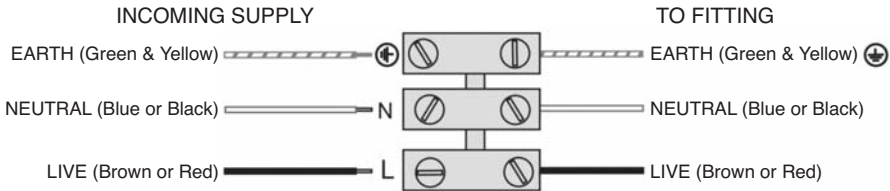
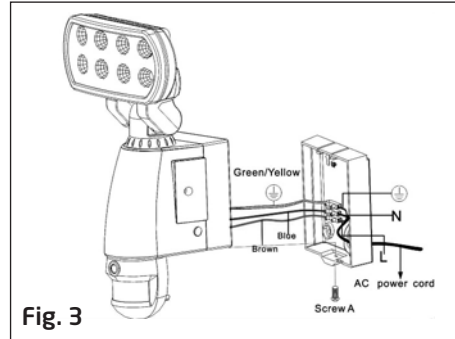

Fig. 2

Step 3 - Mounting your GuardCam LED

1. Place plastic masonry plugs into desired surface aligning holes as shown below. Using an electric screwdriver, fasten mounting plate directly to surface using screws E.
2. Feed the cable through the back mounting box and bush the cable entry to avoid abrasion to the cable.
3. Wire the unit as follows: (Ensure all wires are connected securely and that no loose strands are exposed)



4. Make sure the polarity is correct. Double check the connections after wiring. Errors may damage the motion sensor or cause a fire hazard.
5. Attach the unit to the mounting plate. You will first need to angle the unit back so that the catch at the top of the mounting plate fits into slot on the back of the unit. Next lower the unit until holes at the bottom of the mounting plate and unit are flush. Then screw (screw A) into this hole, tightening carefully.

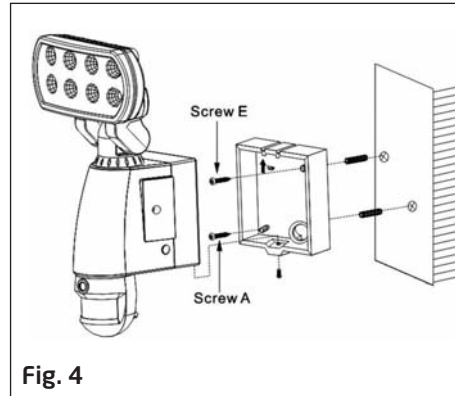

Please allow 1 minute warm-up time after switching on.

- Push the RESET button after switching on.

Remove plastic lens cover from camera after installation. (see Fig. 5)

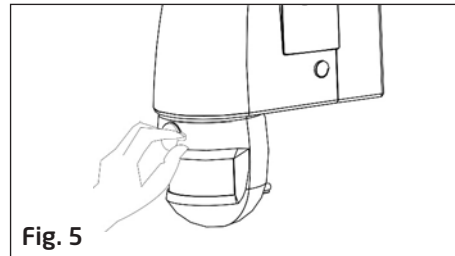

Step 4 - Adjusting the Settings (see Figs. 6 - 8)

- **Time control:** Turn the time control knob to "+" side to increase the illumination time (7 minutes max.), turn the control knob to "-" side to reduce the illumination time (5 seconds min.)
- **Sensitivity control:** Adjust the detector range of Passive Infrared Motion Sensor ($\pm 2M \sim 10M$)
- To perform a walk test turn the knob fully to the "-" side until the indicator faces the "W" mark. When the walk test is completed adjust the knob to the "+" side to your desired lamp on time (we recommend this be at least 20 seconds to ensure lighting of the area is sufficient for recording - 20 seconds is marked as "20" on the product).

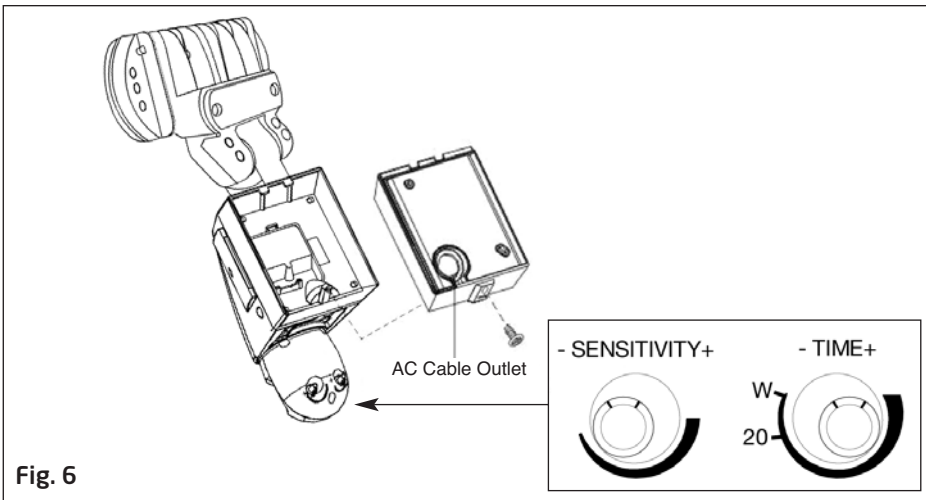

- **Selecting working mode:**
 - Mode 1:** Floodlight, Camera and Speaker in operation both day and night
 - Mode 2:** Daytime: light is OFF, camera is ON, speaker is ON
Nighttime: light is ON, camera is ON, speaker is OFF
 - Mode 3:** Daytime: light is OFF, camera is ON, speaker is OFF
Nighttime: light is ON, camera is ON, speaker is ON

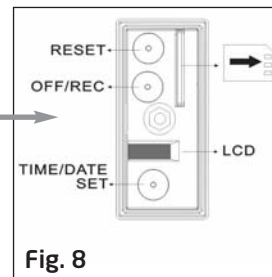
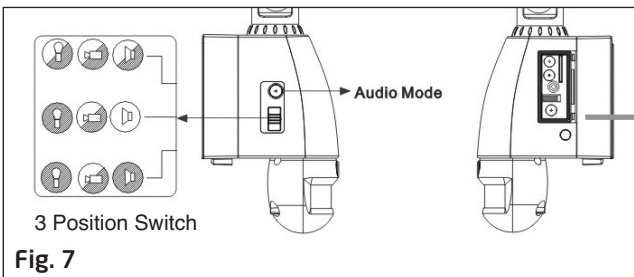

■ Audio mode:

To Change audio mode press the audio mode button (Fig. 8). The audio mode will cycle through the available options on each push.

Option 1 : Warning you are being recorded by a security camera

Option 2 : Dog barking

Option 3 : Self recorded message 1 (max 10 sec)

Option 4 : Self recorded message 2 (max 10 sec)

Option 5 : Off

■ Recording your own messages (Fig. 9)

Guardcam will allow you to record two messages of your own for delivery on detection. To achieve a good quality playback it is best practice to make these recordings prior to final installation speaking clearly in an environment free from background noise. The microphone is located at the base of the unit directly above button A.

Two separate messages may be recorded for a maximum length of 10 seconds each.

To record a message press and hold button A. After the "bleep" release button A and record your message. When finished press button A again to stop recording, you will here a double confirmation bleep.

To record a second message simply repeat the process.

To check the recorded message/s press and release button B. Should you wish to delete a self recorded message press and hold button B for 3 seconds, a double bleep will confirm deletion.

NB If you attempt to record a new message without first deleting an old message you will hear a triple error bleep.

Please note:

Should the power to GuardCam be removed the sound setting will revert to option1 "warning you are being recorded by a security camera" as a default. If you wish to switch sound off completely please press the sound on/off button located on the base of the unit. See Fig 9.

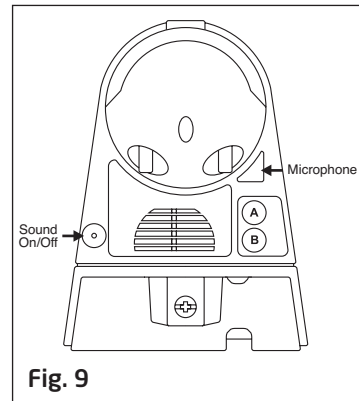

Fig. 9

Status Lamp (below SD card housing)

1) Red: SD card write error, check SD card is inserted, check SD card lock is off (found on left edge of SD card). If error still exists, format SD card (see page 2).

2) Green: The unit is recording.

3) LED off: stand by (SD card is inserted into the slot), when off/record button is pressed.

● Please note when off/record button is pressed, remove SD card within 30 seconds (now the status lamp will turn red after SD card is removed from the slot)

■ **Reset button:** restore functions to default settings

1) Press RESET button once each time you turn on unit.

2) Please press this button in case of system malfunction.

■ **Off/Rec:** Please press Off/Rec button to remove SD card. Please remove card within 30 seconds of pressing the Off/Rec button to avoid loss of data.

Step 5 - Set the Date and Time and Video Mode

This will allow the images taken by GuardCam to display the correct date and time it was taken.

Push **TIME/DATE SET** button (see Fig. 10) for 3 seconds, The LCD screen will then flash 3 times, indicating you have entered Time/Date setting mode.

1. **"YEAR" setting:** "Y" and "08" are displayed on the screen; push the button to set year from "08-99", push the button again and hold for 3 seconds to scroll through numbers quickly. If you have not pressed the button for 3 seconds, it will automatically save the year and go on to allow you to set the month.

Repeat the same setting procedure for MONTH / DATE / HOUR / MINUTE / VIDEO MODE.

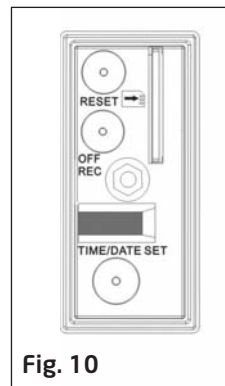



Fig. 10

2. **Video mode setting:** automatically at the end of the time date setting two icons  and  "V" appear on the screen; push the button to choose "V" (Video) or "P" (Photo).

On the "P" (photo) setting, GuardCam will take a series of digital photographs at a rate of 1-3 photos every second when the motion sensor is triggered.

On the "V" (video) setting, GuardCam will take a 20 second video clip when the motion sensor is triggered.

Please note that in the event of a mains power failure GuardCam will revert to the factory setting of "V".

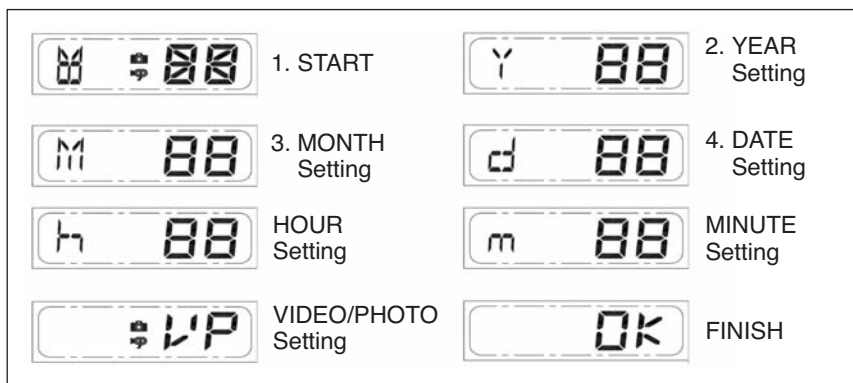

If you have not pushed any buttons for 3 second, "OK" will appear on the screen, indicating it has automatically saved the current settings. The LCD screen will shut off automatically 10 seconds later.

Please note that in the event of a mains power failure in excess of 72 hours the time and date settings must be reset.

Step 6 - Viewing Video

Viewing image by computer through USB card reader supplied (see Fig. 11)

- Open SD card housing with allen key supplied
- Press OFF/REC button and remove SD card from the slot.
- Put the SD card into the USB card reader supplied, then insert the card reader into PC via a USB port and open Windows Media Player to view the video.

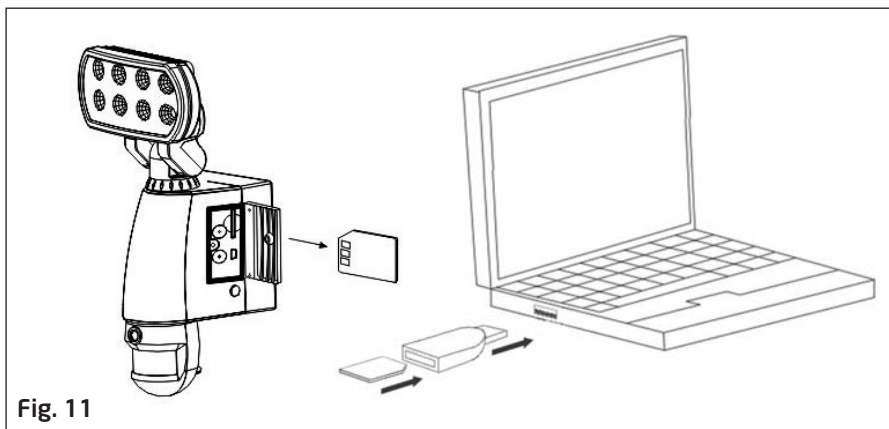

Technical Specifications

Features and specification:

- PIR detection angle 160 Deg and detection range up to 10M
- Records 20 seconds image recording for image stream: 10fps at 480*640 Pixels
- Built in SD card slot for SD memory card
- SD card slot for additional storage, max memory size up to 32GB
- SD card spec.: FAT16 (SD) / FAT 32(SDHC)
- Automatic exposure control, white balance and sharpness
- Auto Date & Time stamp
- Effective viewing angle: 60 deg
- Effective viewing distance: 8M
- Image format: JPEG AVI File
- Powered by AC 100V to 240V (subject to requirement)
- 8pcs 1W Nichia super power white LED
- Auto light sensor
- Sensitivity control
- Floodlight time delay control

General Information and Safety

SPECIAL CARE INSTRUCTIONS

- The GuardCam LED Motion Light with Video Camera is designed to be weather resistant. Never attempt to immerse the unit in water or any other liquid. This will damage the unit and void the warranty.
- This product is designed to illuminate, video, and make verbal announcements. It will not prevent the commission of any act, legal or illegal. The manufacturer assumes no liability for any damage to property, injury to person, or death.
- Use a soft lens cloth for cleaning lens. Avoid touching lens with fingers.
- Remove dirt or stains with a soft cloth dampened with water or neutral detergent. Keep the GuardCam LED Motion Light with Video Camera in a dry and cool dust-free environment or container when it is NOT used
- Do not open the GuardCam LED Motion Light with Video Camera for unauthorized service. This could cause serious damage to the unit and will void the warranty.
- This GuardCam LED Motion Light with Video Camera is a precision electronic device. Do not attempt to service this camera yourself, as opening or removing covers may expose you to the danger of electric shock or other risks.
- To avoid risk of burns due to high temperature do not touch the floodlight when it is turned on.

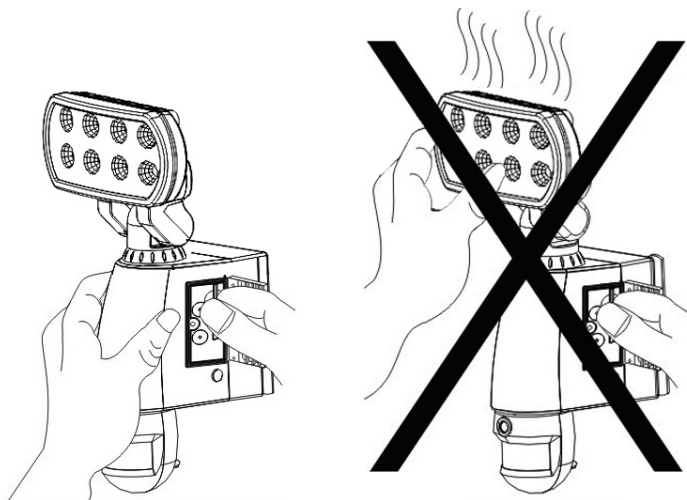

Elite Security Products
Unit 7, Target Park, Shawbank Rd
Lakeside, Redditch B98 8YN



Telephone: 01527 515150
Fax: 01527 515143
email: info@espuke.com

www.espuke.com