



APMONWG | APMONBG - COLOUR VIDEO DOOR ENTRY MONITOR



USER MANUAL



www.espuk.com



Contents

Monitor Functions Overview	4
Installation	5
Master / Slave Setup	6
Setting Address ID - Only required for apartment systems	7
Setting the Time and Date	8
Monitor Image and Talk Volume Adjustment	9
Changing Monitor Ringtone	10
Monitor Ringtone Volume Adjustment	11
Preview Door Station's Camera Image	12
Inner Call - Calling to another monitor on the system or within the apartment	13
Intercom Call - Calling to another monitor for multiple occupancy system	14
SD Card Record and Viewing Options	15
Monitor Installation Setup - Setting the monitor as a Guard Unit	16
Guard Unit Facility - Calling to a monitor set to 'Guard Unit' mode	17
Restore Monitor Settings to Default	18

System Cabling

All system cabling (excluding mains 240vAC supply) has been tested with Cat5E UTP PVC cable.



Part Number - A8NFORCE5EUTP

Find this product online:
elandcables.com | Cables & Accessories | LAN Cable | Cat 5E UTP PVC Cable

Monitor Functions Overview

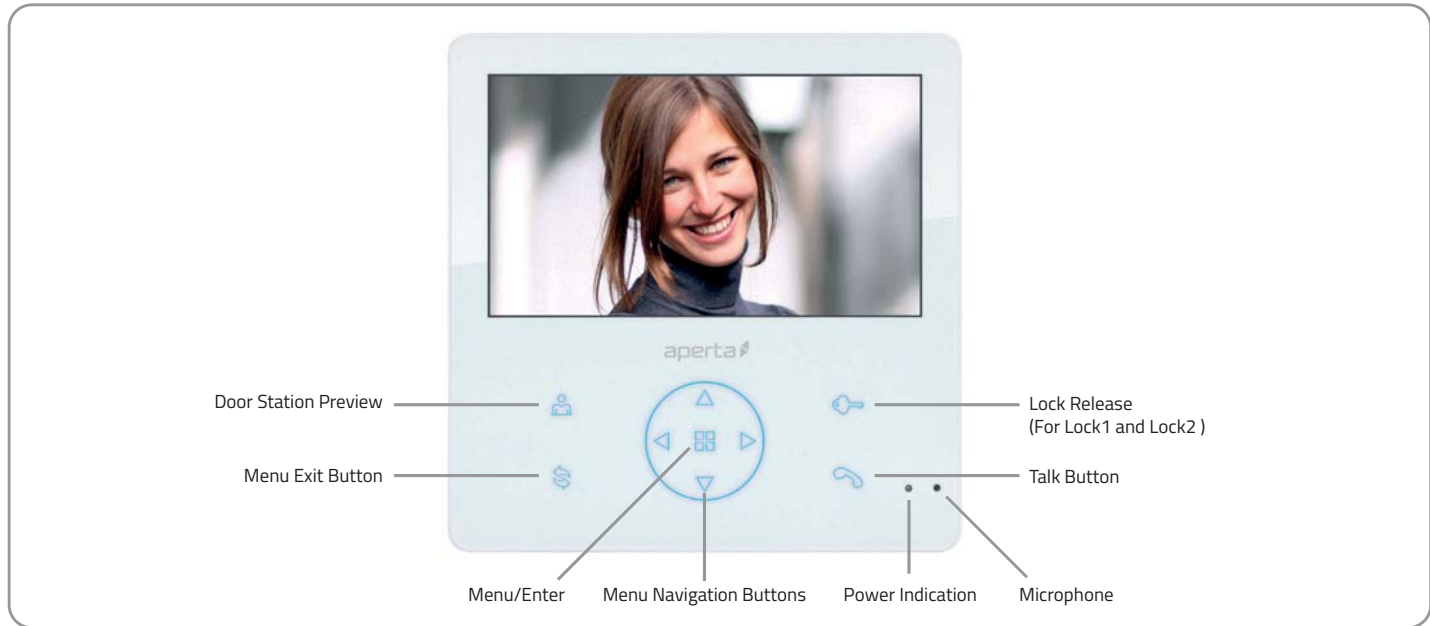

A



The visitor presses the call button on the door station

B



A chime will sound from the monitor

C



The visitor's image will appear on screen

D



Press the 'Talk' button and begin conversation

Then choose between these 2 options



Press the 'Talk' button to end call



Press the 'Lock' button and select Lock1 or Lock2 to release

Installation



Site the indoor monitor to suit application.

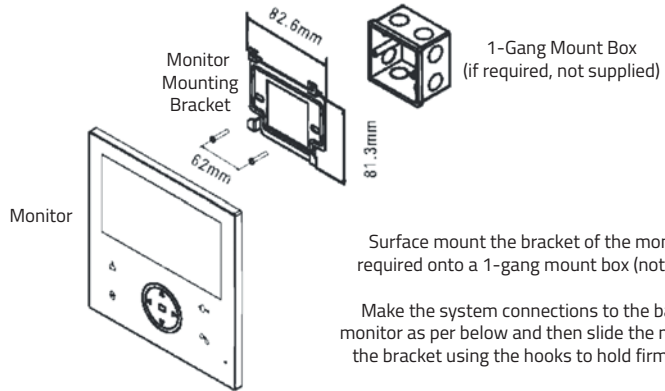

Surface mount the bracket of the monitor or if required onto a 1-gang mount box (not supplied).

Make the system connections to the back of the monitor as per below and then slide the monitor onto the bracket using the hooks to hold firmly in place.

Rear View of Monitor

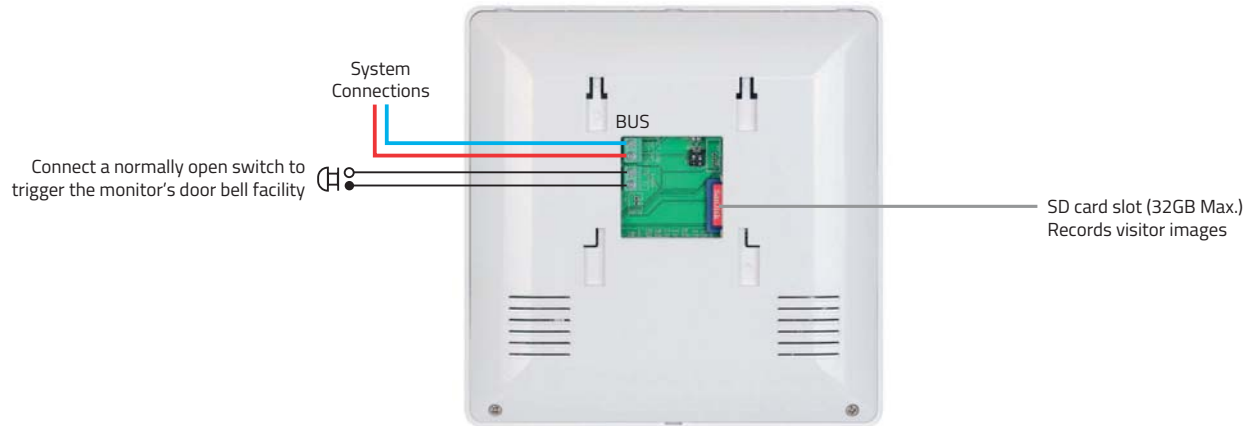

Master / Slave Setup

Switch Setup

For villa system:
Only 1 monitor is set as a MASTER.
All other monitors are set to SLAVE.

For apartment system:
Each Address ID has 1 MASTER.
All other monitors on the same
Address ID are set to SLAVE.

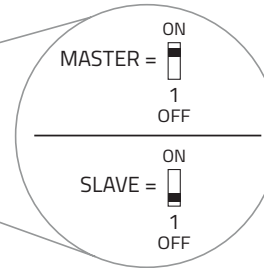
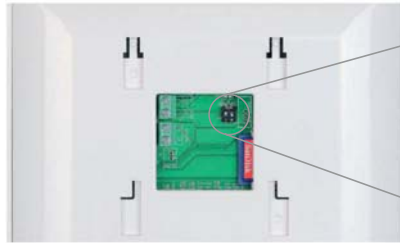

Menu Setup

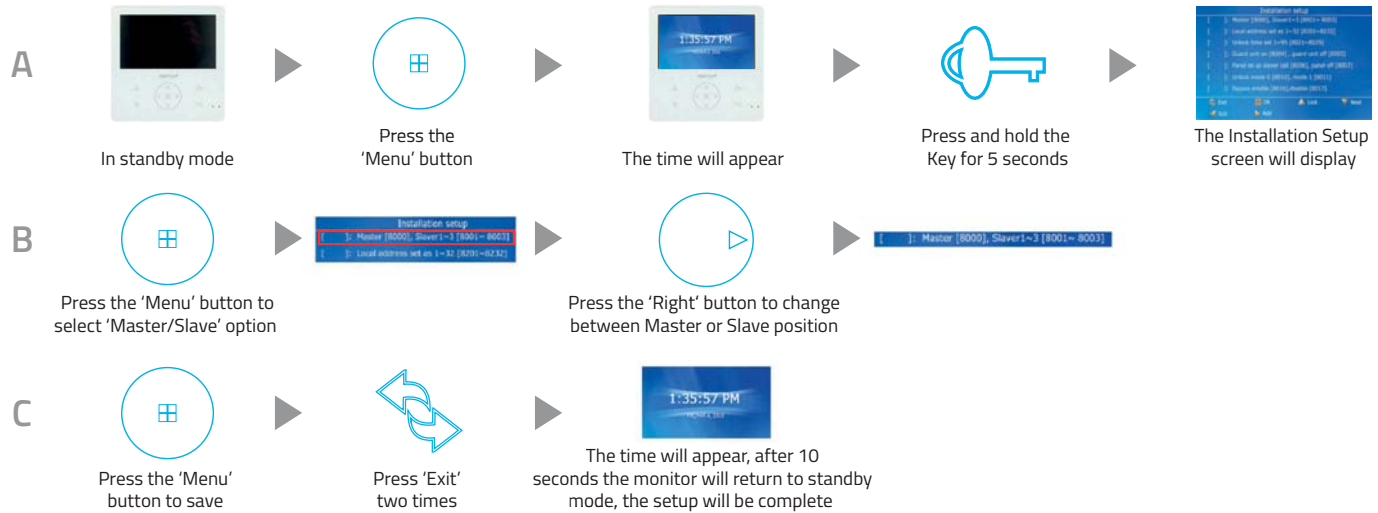

Setting Address ID - Only required for apartment systems

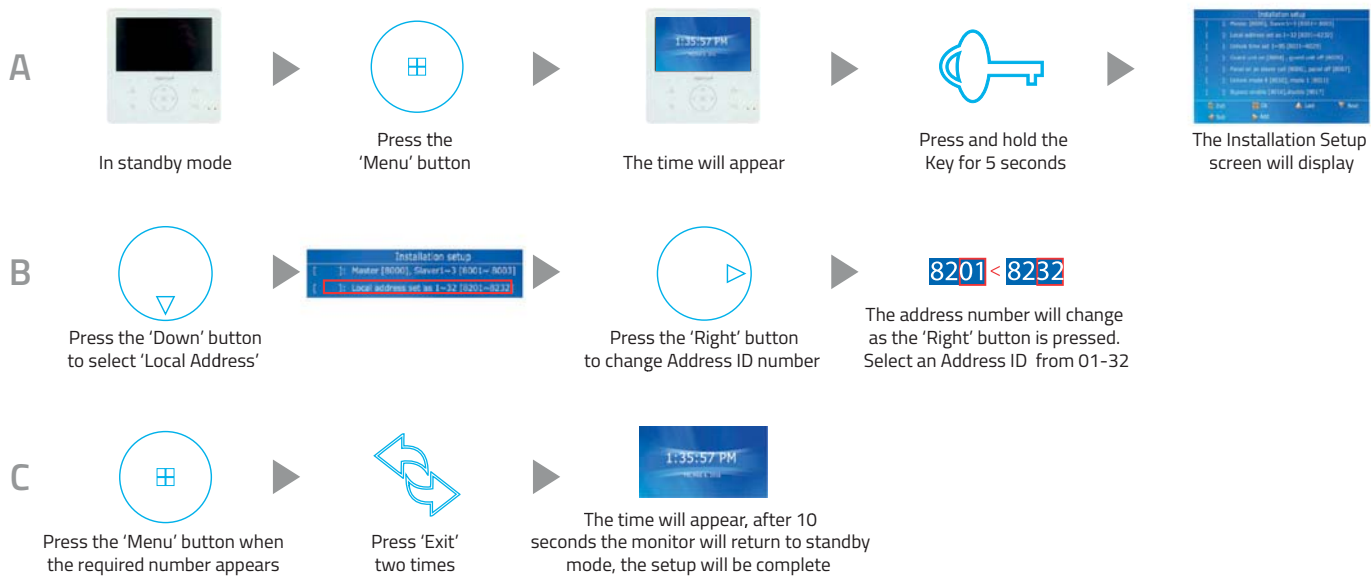

Setting the Time and Date

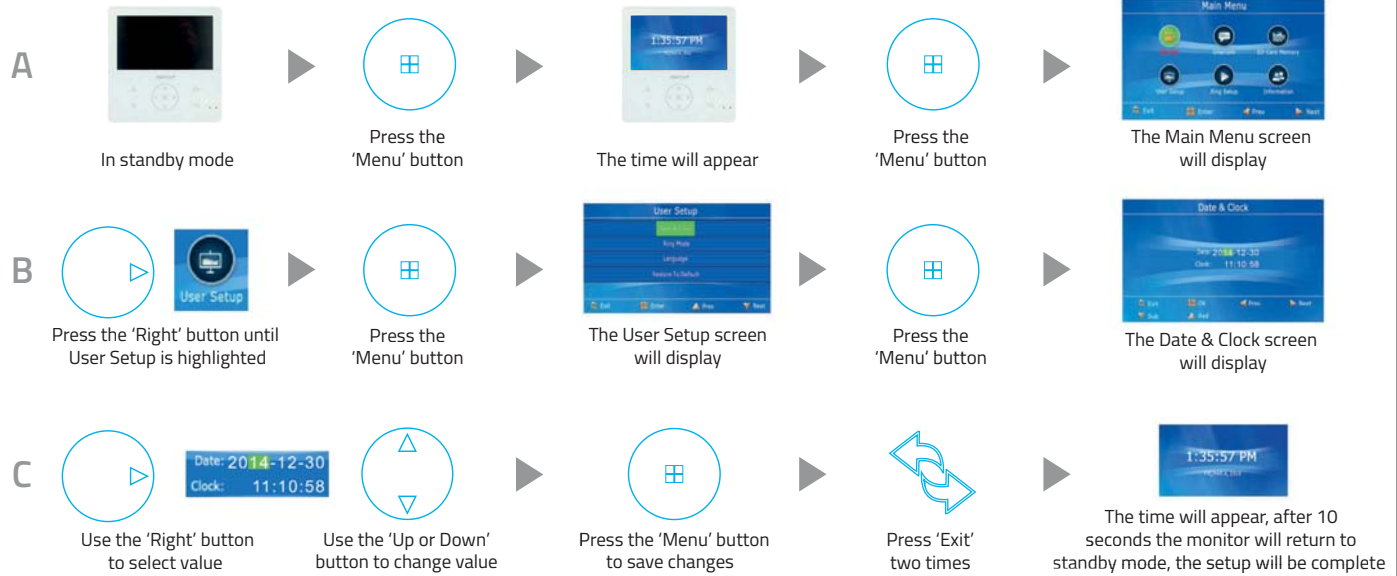

Monitor Image and Talk Volume Adjustment

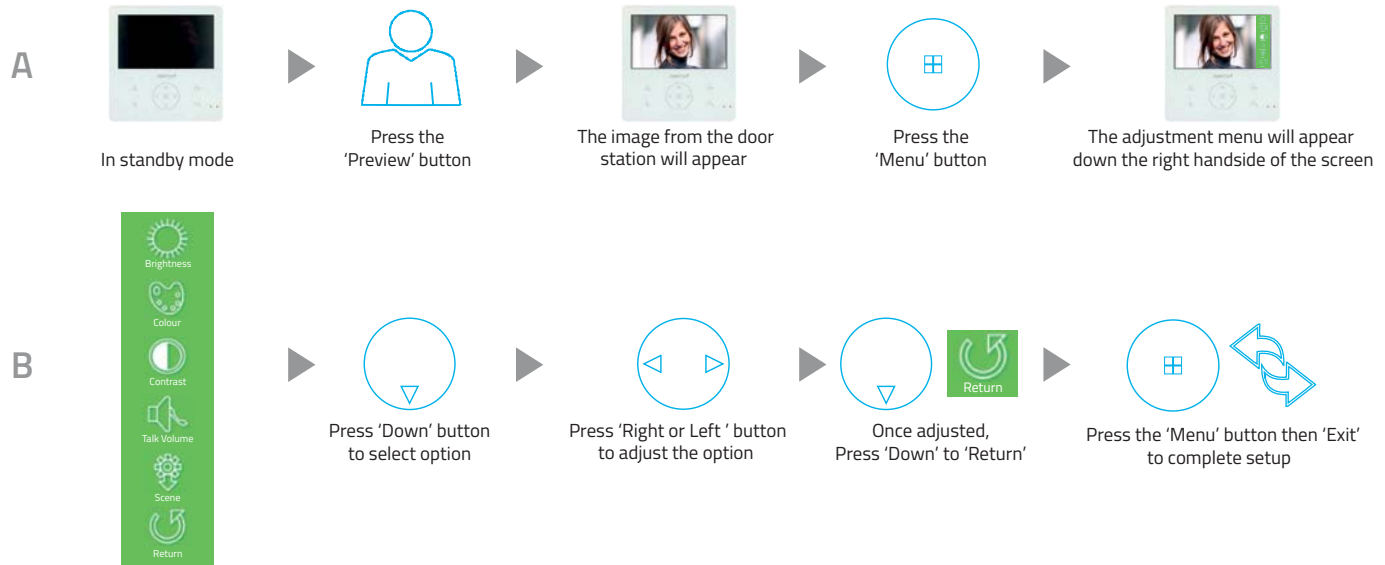

Changing Monitor Ringtone

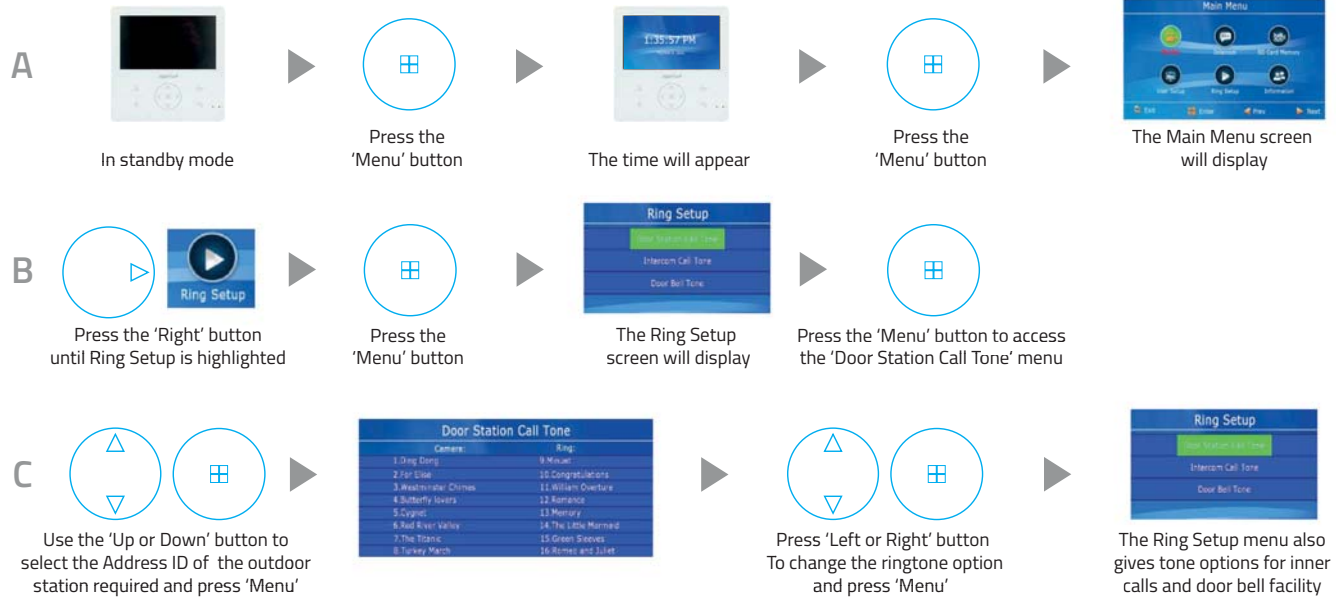

Monitor Ringtone Volume Adjustment

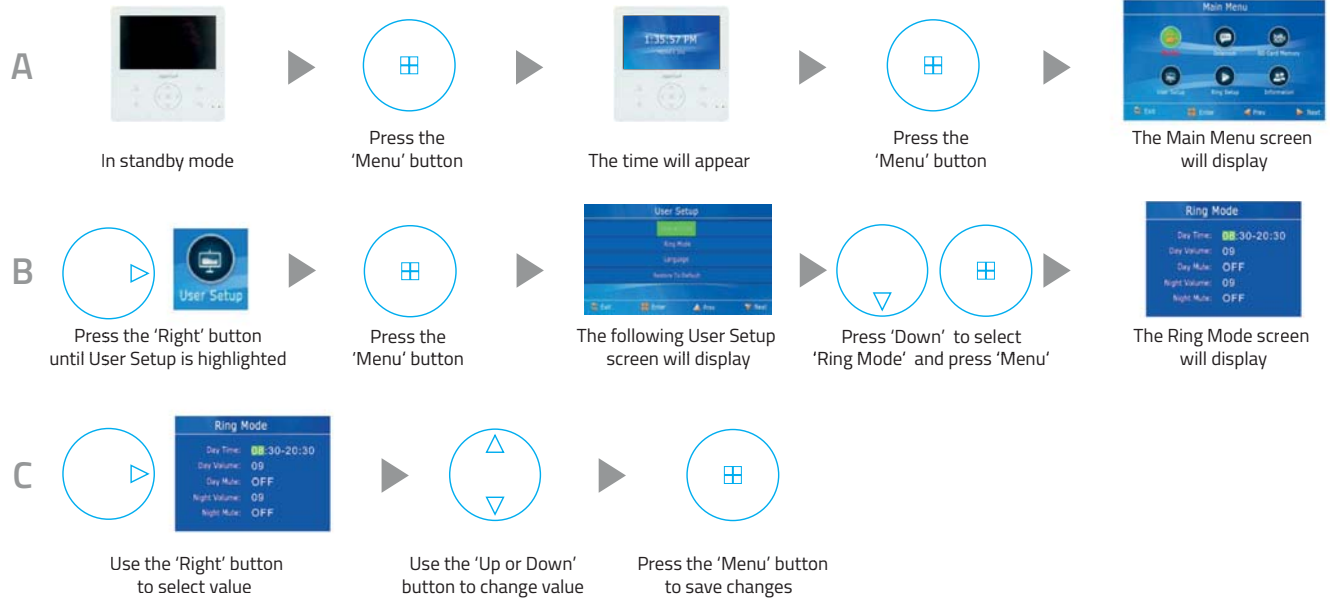

Preview Door Station's Camera Image



Inner Call - Calling to another monitor on the system or within the apartment

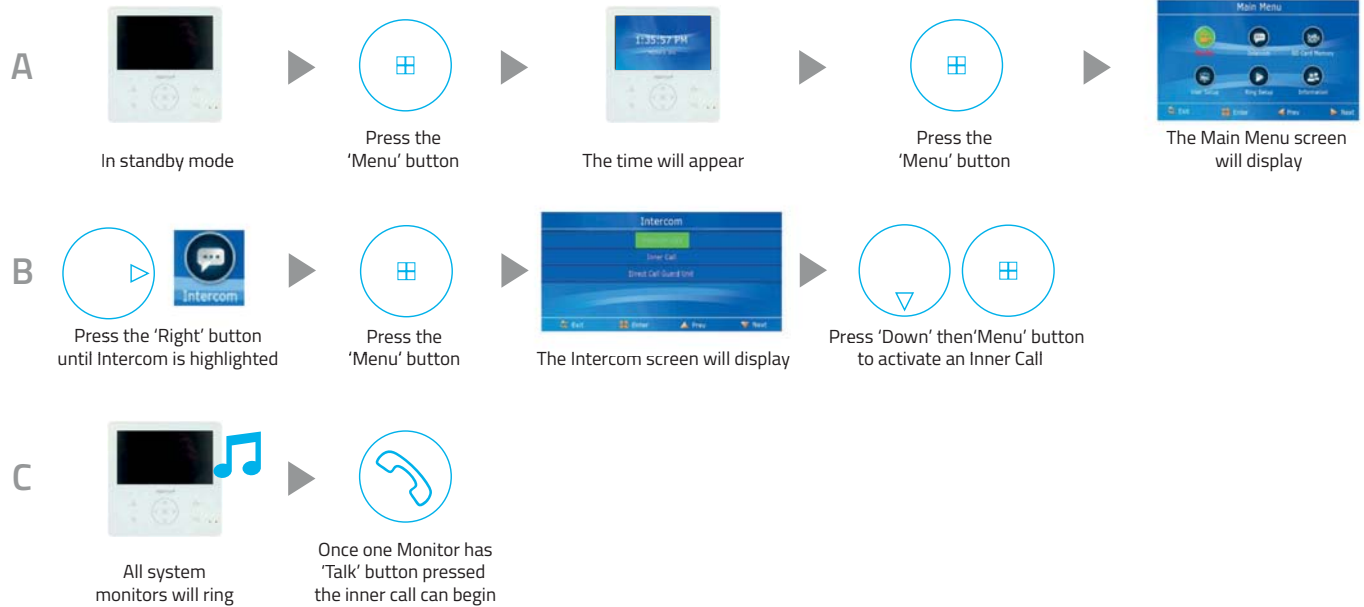

Intercom Call - Calling to another monitor for multiple occupancy system

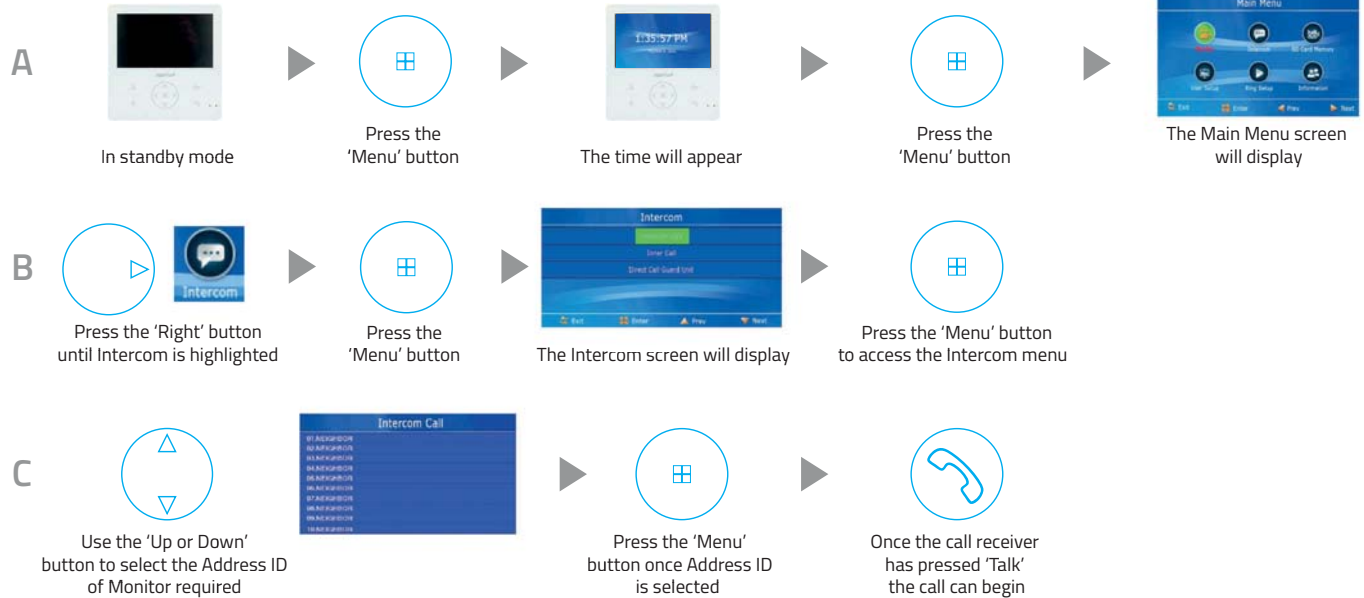

SD Card Record and Viewing Options

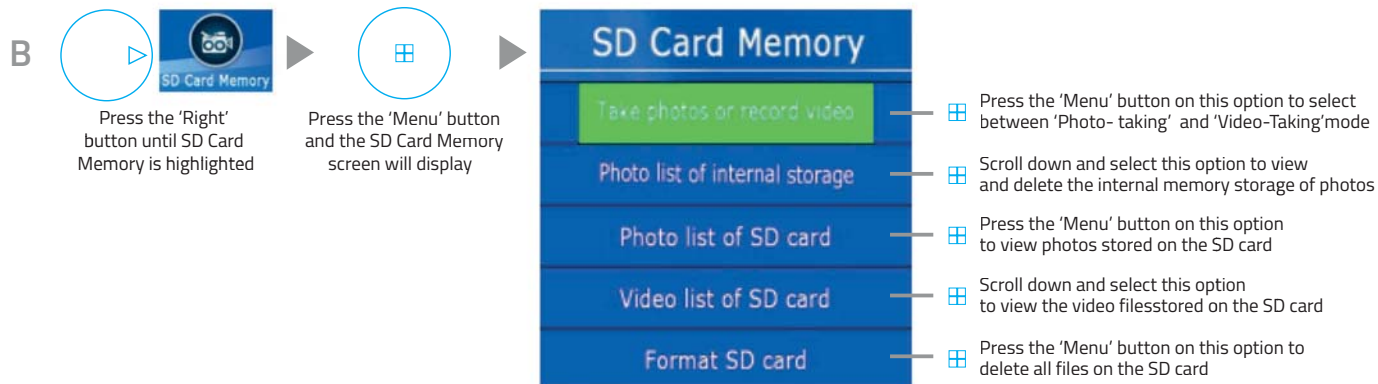

Monitor Installation Setup - Setting the monitor as a Guard Unit

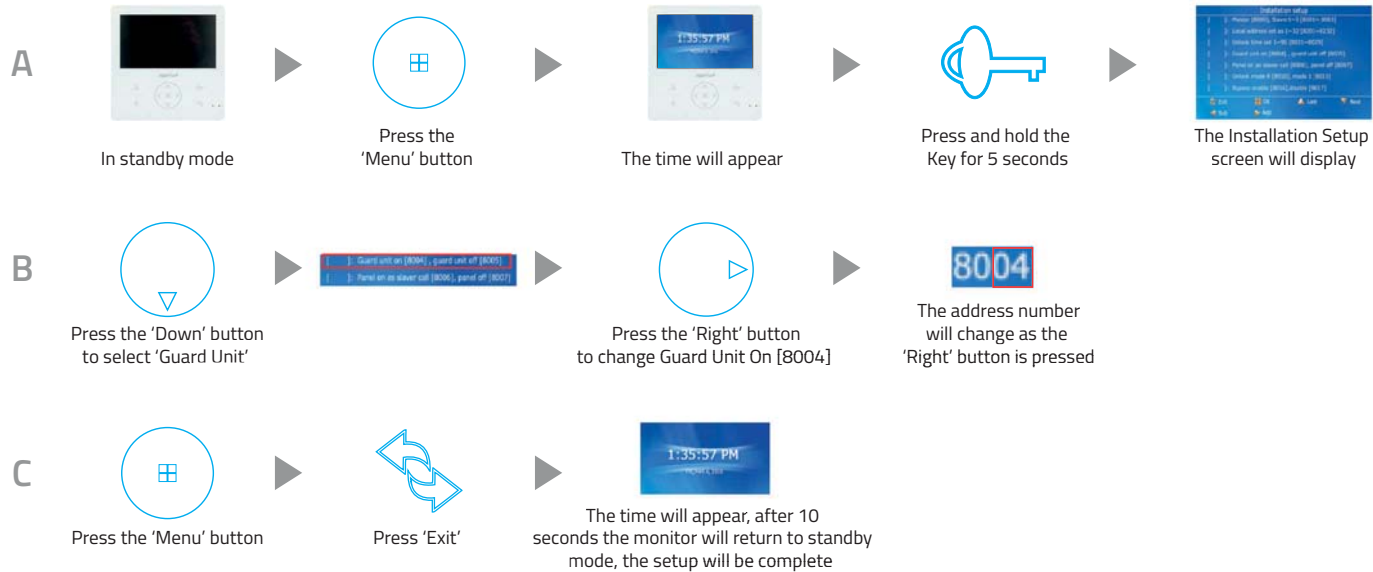

Guard Unit Facility - Calling to a monitor set to 'Guard Unit' mode

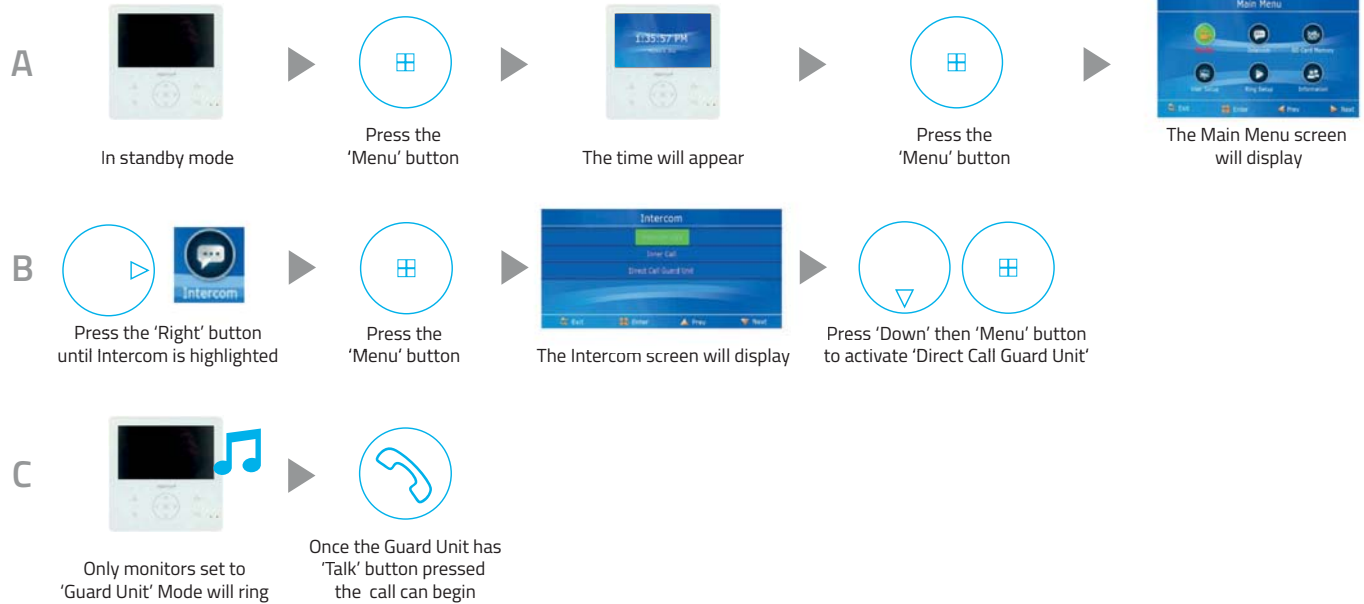

Restore Monitor Settings to Default

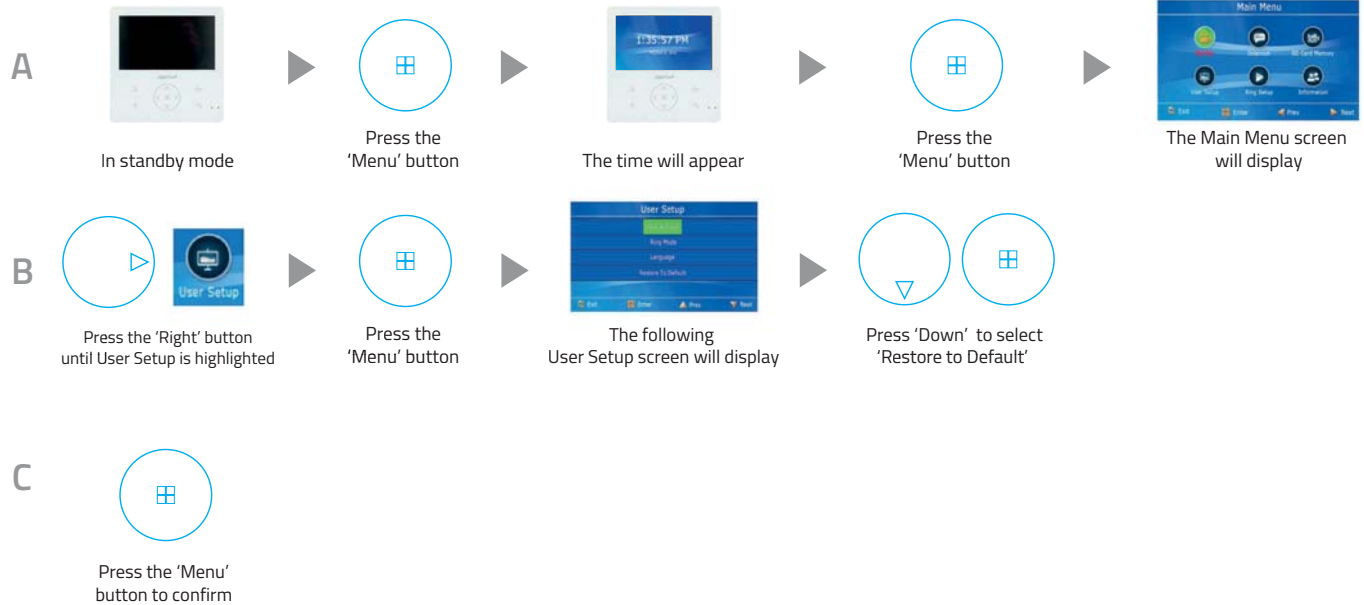





Elite Security Products
Unit 7, Target Park, Shawbank Rd
Lakeside, Redditch B98 8YN



Telephone: 01527 51 51 50
Fax: 01527 51 51 43
email: info@espuk.com

E&OE - Errors and omissions excepted. A16

www.espuk.com

