

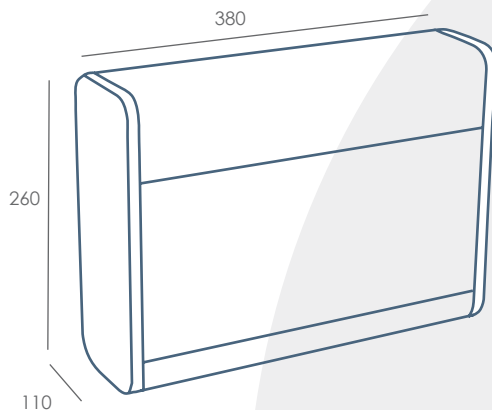

ECO EcoKill 40

ELECTRIC FLY KILLER

Highly Effective Electric Fly Killer



The **EcoKill 40** is slimline and ideal for use in all commercial environments!

Using energy-saving EcoLite tubes (high UV output) to provide the optimum catch rate and ensure you have an effective fly killing machine!



WHY PESTSENZ?

- We provide a variety of high quality, effective insect control products; fly killers, glue boards and UV tubes
- Easy to service units
- Certified to RoHS and relevant European standards

FEATURES

- Highly effective and aesthetically pleasing
- Energy-saving EcoLite tubes
- Wall mounted, ceiling suspended or free standing
- Non-clogging, powerful electric killing grid
- Simple to remove deep tray
- Stainless Steel construction
- Separate lead for easy disconnection
- Built in micro switch to ensure safe access
- ABS end caps with light slots to enhance coverage and effectiveness
- 60w version available

FINISH	COVERAGE	VOLTAGE	DIMENSIONS (mm)
Stainless Steel	120 m ²	230 v	W380 x H260 x D110mm

BOXED QTY	UNIT WEIGHT	BOXED UNIT WEIGHT	TUBE	WARRANTY
5	2.5 kg	3 kg	2 x 20 w EcoLite	1 Year



T13



SERVICING

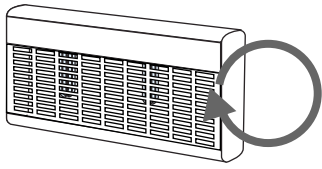

1. Unscrew the side caps

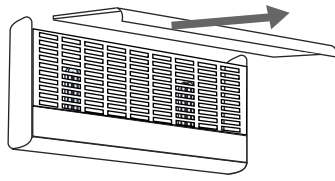

2. Turn the unit upside down and slide the bottom panel off

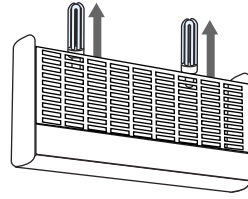

3. Unscrew and remove the EcoLite tubes

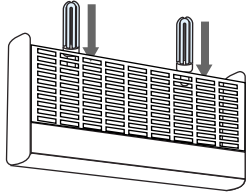

4. Replace with new EcoLite tubes

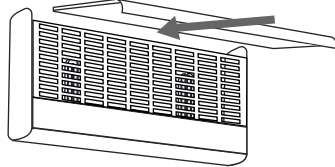

5. Replace the bottom panel

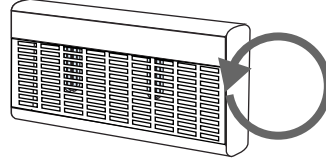

6. Turn the right way up and screw the side caps back in place

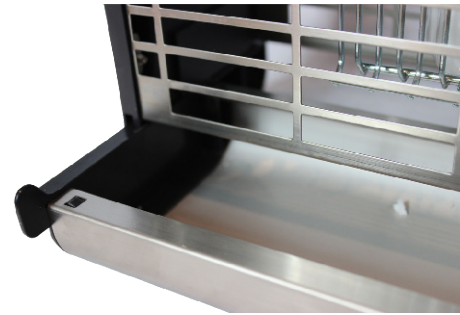

IDEAL FOR USE IN



TAKEAWAYS



OFFICE



AGRICULTURAL



HOME



CINEMAS



RESTAURANT



CAFE / BAR



FRONT OF HOUSE



Control Zone Products
Units 108 & 206
Pannal Business Park
Station Road
Pannal
HG3 1JL
UK

+44 (0) 1423 855600
+44 (0) 1423 855601
info@controlzoneproducts.co.uk