

12V Marktrack Spot TH300X

product data sheet



Description

Low voltage miniature spotlights for use exclusively with 12V Marktrack or for surface mounting. Ideal in application where unobtrusive profiles are required.

APPLICATIONS

Ideal for highlighting and general lighting in retail, commercial and domestic applications, particularly where unobtrusive, compact spotlights are required.

SALES FEATURES

Comprehensive range

Three styles; track versions for use with Marktrack; surface-mounting versions; pendants available to special order. White, black finish.

Quality

Spotlights can be angled through 90° and rotated through 355°. F-marked: suitable for direct mounting on flammable surfaces. Guaranteed for five years.

Ease of installation

Bulldog' clip adaptor for quick attachment or removal from the track.
Comprehensive instructions

Lamp description

High-intensity light output.
Bright, white light.
Precise beam control.
Wide selection of wattages and beam angles.
Energy saving and longer lamp life compared with standard incandescent lamps.

TECHNICAL SPECIFICATION

Technical Data

Cut out dia. (mm)	0
IP Rating	20
Weight (kgs)	0.11
Input Voltage(V)	12V
Dimming	Suitable for dimming if used with a dimmable transformer and a suitable dimmer

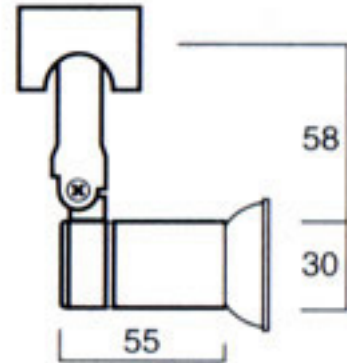

MATERIALS

Body	Diecast Aluminium
Stem	Moulded Polycarbonate
Adaptor	Moulded Polycarbonate
Lampholder	Ceramic
Finish	Powder Coated

LAMP DATA

Lamp Type	Lamp Cap	No.	Lamp Watts	Lamp Current	Lamp Lumens	Lamp Life
MR16 12V	GX/GU5.3	1	20	1.7	350	3000
MR16 12V		1	35	2.9	600	3000
MR16 12V		1	50	4.2	950	3000