



Commercial  
Shallow Recessed Downlights  
TC-S 7W and 9W



Read these instructions before commencing installation & retain them for future reference.

This fitting for the main part, has been manufactured from metal materials. The fitting therefore includes an earth connection. Product must be earthed.

Fitting Instructions:-

It is recommended that luminaires are installed and fitted by a qualified electrician. The installation of this product must comply with the current edition of the IEE wiring regulations BS7671. For luminaires to be installed in bathrooms, saunas or swimming pool complexes special attention should be paid to section 601, 602 & 603 of the above standard. To install fitting loosen 3 x clip retaining screws, insert fitting as drawing shows then re-tighten screws.

IMPORTANT USER ADVICE

Always switch off mains supply before servicing, fitting or changing lamp. Check the lamp is correct for the application, including its voltage and wattage.

Ensure that the lamp is correctly located in the lampholder. Switch on electricity at mains.

If in doubt ring the Product Help Line:  
01243 829040 (Ask for Technical sales)



Code	Lamp (W)	Cap	Rim Ø	Cut-out Ø	Void
JC5019	2 x 7W	G23	168mm	150mm	90mm
JC5020	2 x 9W	G23	193mm	185mm	90mm

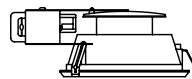

**JC5019 CH,**  
GO or WH  
X7Watt  
TC-S G23

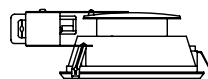
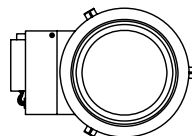

**JC5020 CH,**  
GO or WH  
2 X9Watt  
TC-S G23

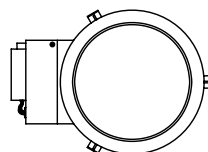

Wiring Colour Code

(L) Live -  
Brown or Red

(⊕) Earth -  
Yellow and Green

(N) Neutral -  
Blue or Black

Connections

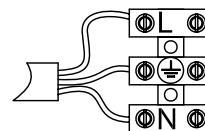

BS EN ISO9001 - 2000  
Registered Firm  
Certificate No. GB 1552

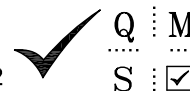

Product Information

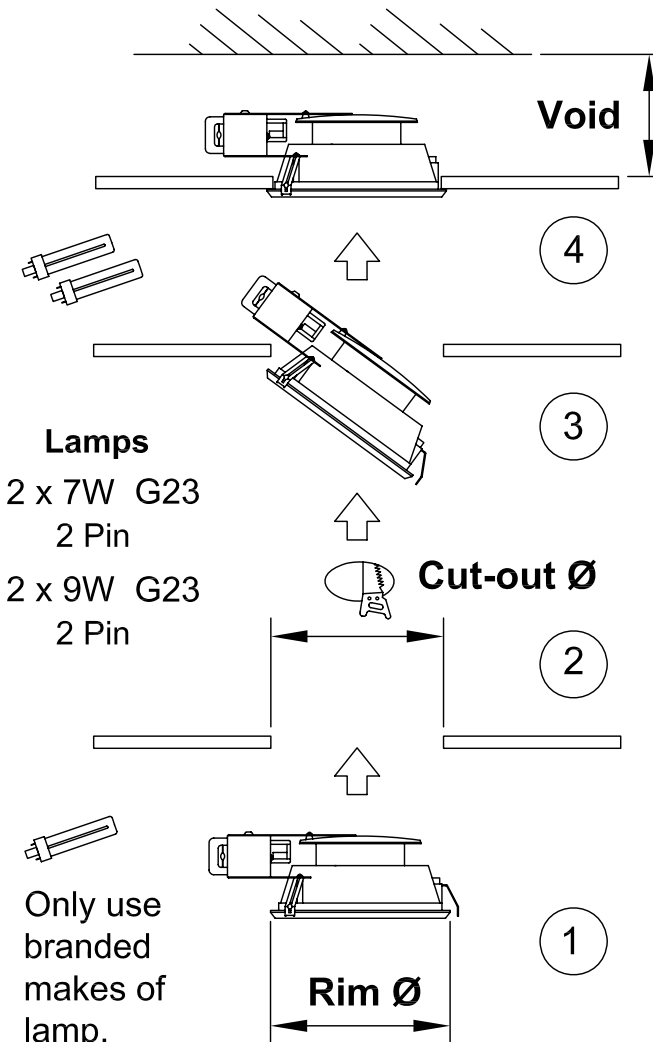

Only use  
branded  
makes of  
lamp.