





Available finish: White

Read these instructions before commencing installation. Please give these instructions to the owner/occupier after installation to retain for future reference/maintenance.

IP65    220-240V AC~50/60Hz

These fittings are Class II and do not require to be Earthed

### Important Information

It is recommended that these controls are installed and fitted by a qualified electrician ensuring the installation complies with current IEE wiring regulations & local building control. These products are designed for connection to a 220-240V~50/60Hz supply. Any faulty, broken or damaged sensors should be replaced immediately.

KSR will not accept responsibility for any claims arising from a poor installation.

Please Note: The limited warranty shall be deemed null and void in the following circumstances: Failure by the installer, end user or any third party to exercise caution to protect any covered product or part from outside damage, adverse temperature, humidity conditions, fluctuations in the electrical system or physical abuse as well as failure related to workmanship in the installation of the products or parts.

### Important User Advice

Always switch off mains supply before fitting or servicing.

This control is suitable for indoor use only.

Do not use Megger or similar high voltage instruments. Due to the fact this control contains electronic components that maybe damaged by high test voltages, they must be disconnected from the circuit before testing.

To prevent damage to the control, do not mix with conventional magnetic ballasts on the same electrical circuit.

At the end of life the luminaire is classed as WEEE under directive 2014/30/EU and should be disposed of in accordance with local legislation.

Please note these luminaires are non-dimmable.

### Installation Procedure

KSR recommends that you familiarise yourself with the installation. Once you are completely satisfied:

Safely isolate the mains supply.

Locate the area's suitable to install this control on the luminaire.

**As the detector responds to changes in temperature, avoid the following situations:**

Avoid pointing the detector towards objects with highly reflective surfaces, such as mirrors etc.

Avoid mounting the detector near heat sources, such as heating vents, air conditioning units, lights etc.

Avoid pointing the detector towards objects that may move in the wind, such as curtains, tall plants etc

Ensure that no obstructions are in the line of sight.

Using a suitable hole install the sensor into the luminaire ensuring the seal is located to retain the correct IP rating.

Connect the wiring as per Fig. 1.

Switch on the power.

The sensor will go through it's initial startup procedure (approximately 30 seconds).

When the sensor receives the induction signal, the lamp will turn on.

For the initial setup turn the LUX control to the Sun position and the TIME to 10S.

Once the sensor has no trigger the sensor should turn off after approximately 10 seconds.

Once you are happy the sensor is working correctly.

Adjust to the required time and lux settings.

Fig. 1

Brown - Live (In)

Blue - Neutral (In)

Red - Live (Out)

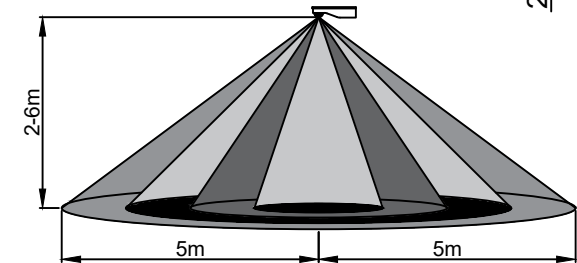
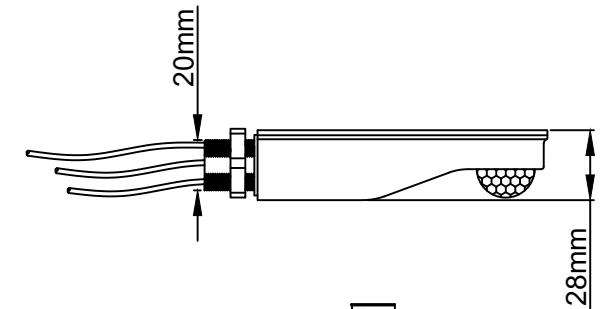
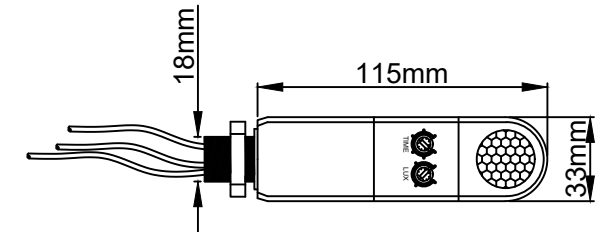
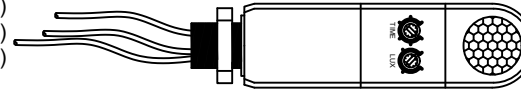

### PIR Specification:

Mains Input - 220~240VAC 50/60Hz

Lux Control - <3-2000 Lux Adjustable

Time Setting - Min 10 Seconds +/- 3 Second

Max 30 Minutes +/- 2 Minutes

Rated Load - LED 500W

Halogen 1200W

Detection Area - 360°

Detection Distance - 10m Max (<24°C)

Parasitic Power - 0.5W

Installation Height - 2m~6m

Detection Speed: 0.6~1.5m/s

Working Temperature: -20~+40°C

