













## KT5 Current Voltage Tester

### Content

- 1.0 Introduction / Product Package
  - 2.0 Safety Measures
  - 3.0 Danger of electric shock and other dangers
  - 4.0 Intended Use
  - 5.0 Testers Information
  - 6.0 Preparation for tests
    - 6.1 Auto-power on/ switching on
    - 6.2 Auto-power off
  - 7.0 Conducting Tests
    - 7.1 Voltage test
      - 7.1.1 Low Voltage mode
    - 7.2 Current Test
    - 7.3 Single-pole phase test
    - 7.4 Phase rotation test
    - 7.5 Continuity test
    - 7.6 Diode test
    - 7.7 Resistance test
    - 7.8 Frequency test
    - 7.9 NCV Test
    - 7.10 Torch light
    - 7.11 Self test
    - 7.12 HOLD Function
    - 7.13 Backlight
  - 8.0 Battery Replacement
  - 9.0 Technical Data
  - 10.0 Cleaning and storage
- Warranty

**References marked on instrument or in instruction manual:**

-  Warning of a potential danger, follow with instruction manual.
-  Reference! Please use utmost attention.
-  Caution! Dangerous voltage. Danger of electrical shock.
-  Continuous double or reinforced insulation category II IEC 536 / DIN EN 61140.
-  Equipment for working under live voltage.
-  Conformity symbol, the instrument complies with the valid directives. It complies with the EMV Directive (2014/30/EU), Standard EN 61326-1 are fulfilled. It also complies with the Low Voltage Directive (2014/35/EU), Standard EN61243-3:2014 is fulfilled.
-  UK Conformity compliance mark
-  Tester complies with the standard (2012/19/EU) WEEE.
-  The instruction manual contains information and references, necessary for safe operation and maintenance of the tester.  
Prior to using the tester (commissioning/ assembly) the user is kindly requested to thoroughly read the instruction manual and comply with it in all sections.
-  Failure to read the tester manual or to comply with the warnings and references contained herein can result in serious bodily injury or tester damage.  
The respective accident prevention regulations established by the professional associations are to be strictly enforced at all times.
-  Voltage tester is not a measurement device, it is only allowed to use for testing purposes.

**1.0 INTRODUCTION / PRODUCT PACKAGE**

The KT5 is a universal tester for voltage, current, continuity and rotary field testing with various secondary features.

It complies with the standard for two pole voltage testers EN61243-3:2014.

The KT5 is characterized by the following features:

- Designed to meet international safety standards EN61243-3:2014
- Measurement Category CAT IV / 600V Measurement Category CAT III / 1000V
- AC and DC voltage test up to 1000V with LEDs
- Current test up to 200 AC
- AC voltage test up to 1000V and DC voltage test up to 1500V with LCD
- Cable break tests by Non Contact Voltage detection
- Polarity indication
- Single-pole phase test
- Phase rotation test and Continuity test
- Resistance measurement
- Frequency measurement
- Vibration motor









- Auto-power ON / OFF
- Torch light and IP64 protection

**After unpacking, check that the instrument is undamaged.**

**The product package comprises:**

- 1 pc Tester KT5
- 2 pcs batteries 1.5V,IEC, LR03 (AAA)
- 1 pc operating instructions

**2.0 SAFETY MEASURES**

-  The testers have been constructed and tested in accordance with the safety regulations for voltage testers and have left the factory in a safe and perfect condition.
-  The operating instructions contain information and references required for safe operation and use of the tester. Before using the tester, read the operating instructions carefully and follow them in all respects.
-  Depending on the internal impedance of the voltage tester there will be a different capability of indicating the presence or absence of operating voltage in case of the presence of interference voltage.
-  A voltage tester of relatively low internal impedance, compared to the reference value of 100 kΩ, will not indicate all interference voltages having an original voltage value above the ELV level. When in contact with the parts to be tested, the voltage tester may discharge temporarily the interference voltage to a level below the ELV, but it will be back to the original value when the voltage tester is removed.
-  When the indication “voltage present” does not appear, it is highly recommended installing earthing equipment before work.
-  A voltage tester of relatively high internal impedance, compared to the reference value of 100 kΩ, may not permit to clearly indicate the absence of operating voltage in case of presence of interference voltage.
-  When the indication “voltage present” appears on a part that is expected to be disconnected of the installation, it is highly recommended confirming by another means (e.g. use of an adequate voltage tester, visual check of the disconnecting point of the electric circuit, etc.) that there is no operating voltage on the part to be tested and to conclude that the voltage indicated by the voltage detector is an interference voltage.
-  A voltage tester declaring two values of internal impedance has passed a performance test of managing interference voltages and is (within technical limits) able to distinguish operating voltage from interference voltage and has a means to directly or indirectly indicate which type of voltage is present.

**3.0 DANGER OF ELECTRIC SHOCK AND OTHER DANGERS**

- ⚠ To avoid an electric shock, observe the precautions when working with voltages exceeding 120V (60V) DC or 50V (25V) eff AC. In accordance with DIN VDE these values represent the threshold contact voltages (values in brackets refer to limited ranges, e.g. in agricultural areas).
- ⚠ The tester must not be used with the battery compartment open
- ⚠ Before using the tester, ensure that the test lead and device are in perfect working order. Look out e.g. for broken cables or leaking batteries.
- ⚠ Hold the tester and accessories by the designated grip areas only, the display elements must not be covered. Never touch the test probes.
- ⚠ The tester may be used only within the specified measurement ranges and in low-voltage installations up to 1000VAC and 1500VDC.
- ⚠ The tester may be used only in the measuring circuit category it has been designed for.
- ⚠ Before and after use, always check that the tester is in perfect working order (e.g. on a known voltage source such as the KEWPROVE3 opening unit).
- ⚠ Make sure that the cables tested for current are double insulated.
- ⚠ The tester must no longer be used if one or more functions fail or if no functionality is indicated.
- ⚠ It is not permitted to use the tester during rain or precipitation.
- ⚠ An accurate display is guaranteed only within a temperature range of -15°C to +55°C at relative air humidity less than 85%.
- ⚠ If the safety of the user cannot be guaranteed, the tester must be switched off and secured against unintentional use.
- ⚠ Safety is no longer guaranteed e.g. in the following cases:
  - obvious damage
  - broken housing, cracks in housing
  - if the tester can no longer perform the required measurements/ tests
  - stored for too long in unfavorable conditions
  - damaged during transport
  - leaking batteries
- ⚠ The tester complies with all EMC regulations. Nevertheless it can happen in rare cases that electric devices are disturbed by the electrical field of the tester or the tester is disturbed by electrical devices.
- ⚠ Never use the tester in explosive environment
- ⚠ Tester must be operated by trained users only
- ⚠ Operational safety is no longer guaranteed if the tester is modified or altered.
- ⚠ The tester may be opened by an authorized service technician only.
- ⚠ The current test may only be performed on double insulated cables.

**4.0 INTENDED USE**

The tester may be used only under the conditions and for the purposes for which it was designed. Therefore, observe in particular the safety instructions, the technical data including environmental conditions.

**5.0 TESTERS INFORMATION**

1. Opening for current measurement
2. Test leads (on back side)
3. LED display
4. LCD display
5. On/Off and function button
6. Torchlight and hold button
7. Battery compartment
8. Sensor for cable break detection, NCV

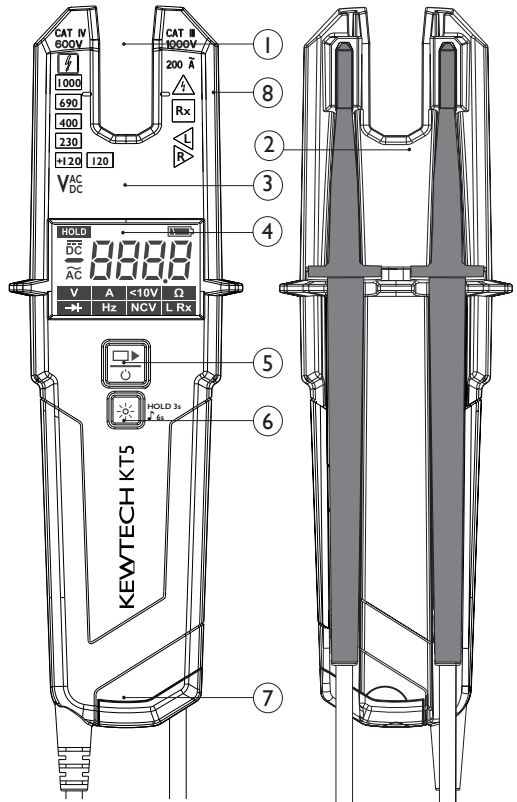

**LED Display information**

1. Voltage indication
2. Polarity indication (120V LEDs)
3. ELV / Single pole indication / Live circuit LED
4. Continuity indication
5. Rotary field indication

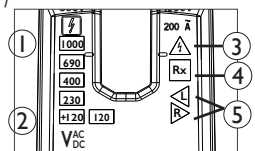

**LCD Display information**

1. HOLD symbols
2. AC/ DC and polarity symbols
3. Function symbols (from left to right, upper row: voltage test, current test, low voltage test, resistance test; lower row: diode test, frequency test, cable break detected by NCV, continuity test).
4. Low battery indication
5. 4 digit 7 segment display

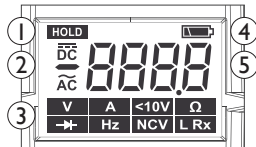

**6.0 PREPARATION FOR TESTS**

**6.1 Auto-power-on/ switching on**

- The tester switches on when it detects shorten tips, or an AC or DC voltage above approx. 6V or a live phase on L2+ (single pole test).
- It can be switched on with a button.

**6.2. Auto-power off**

- Tester is automatically powered off after approx. 10 sec when there is no signal contacted to the probes.
- The torch light automatically switches off after approx. 30 sec.

**7.0 CONDUCTING TESTS**

**7.1 Voltage test**

- Connect both probes to the object under test.
- The voltage is indicated by LEDs if >120V.
- The buzzer and vibration function turn on if the voltage is higher than 50V AC or 120V DC.
- Voltage polarity is indicated in following manner on the LCD.
  - ▶ AC: AC symbol is on
  - ▶ +DC: DC symbol is on
  - ▶ -DC: - symbol and DC symbol is on
- Above 120V, the polarity is shown on the LED display as well.
  - ▶ AC: both 120V LEDs are on
  - ▶ +DC: left 120V LED is on
  - ▶ -DC: right 120V LED is on
- Once the tester is powered on, it will automatically measure voltage in range 6V-1000VAC/1500VDC.
- 🔊 When the L2 probe + is the positive (negative) potential, the Polarity indication LED indicates “+DC” (“-DC”).
- 🔊 During voltage test, L or R LED/Symbol may light up.
- 🔊 In case of empty batteries, only the ELV LED lights up >50V.

**7.1.1 Low Voltage mode – 1V-1000VAC/1500VDC**

- Press On/Off/Function button repeatedly until the LCD shows <10V symbol.
- In Low Voltage mode it is possible to measure AC and DC voltage from 1V.
- Connect both probes to the object under test.
- Voltage display is as in 7.1 described.
- 🔊 Continuity mode is disabled in Low Voltage Mode.

**7.2 CURRENT TEST**

- Press On/off/ Function button repeated until LCD shows A symbol.
- In current test mode, currents between 0.1 A and 200 A can be tested.
- The cable under test needs to be positioned in the centre of the opening and adjacent to the two markings on either side of the the moulding.
- Make sure that only double insulated cables are measured.
- Store test probes safely to avoid any unintended connection.
- The tester will automatically switch to voltage measurement if a voltage is detected >6 V.

**7.3 SINGLE-POLE PHASE TEST**

- 🔊 Function of this test may not be fully achieved if the insulation condition / grounding conditions of user or of the equipment under test are not good enough. Verification of live-circuit should not be dependent on this Single-pole phase test only, but on the voltage test (as in 7.1).
- Hold the tester firmly in your hand. Connect the “L2 +” probe to the object under test. Live circuit LED lights up and the buzzer sounds when a voltage of approx. 100V AC or more exists in the object under test. (Pol≥100V AC).
- Indication of Single Pole phase test is via LED.

**7.4 PHASE ROTATION TEST**

- L LED (symbol) and R LED (symbol) for Phase rotation test may operate on various wiring systems, but effective testing result can be obtained only on a three-phase 4-wire system.
- Hold the tester firmly in your hand and connect both probes to the object under test.
- Phase-to-phase voltage is indicated by Voltage LEDs and LCD.
- R LED lights up for Right rotary field.
- L LED lights up for Left rotary field.
- Measurement principle: The instrument detects the phase rising order regarding the user as earth.
- 🔊 Function of this test may not be fully achieved if the insulation condition/ grounding conditions of the user or of the equipment under test is not good enough.

## 7.5 CONTINUITY TEST L RX

 Make sure the object under test is not live.

- Connect both test probes to the object under test.
- Continuity is shown by the lighting up of the continuity LED and a sound if resistance is below 500 kOhm.
- If a lower threshold for continuity is preferred, low continuity mode can be selected.
  - Press Torchlight-function button repeatedly until the LRx symbol is shown on the LCD.
  - Continuity is shown by the lighting up of the LED and sound if resistance is below 20 Ohm.
- ▶ The continuity test is performed automatically in all modes except in Low Voltage and Resistance mode.
- ▶ The tester automatically switches to voltage measurement if a voltage is detected >6V - during continuity testing.

## 7.6 DIODE TEST

 Make sure the object under test is not live.

- Switch into diode testing mode by pressing On/Off-function button repeatedly until  symbol is shown on the LCD. Connect both test probes to the diode under test.
  - ▶ The continuity LED lights and the buzzer sounds when L1 is connected to the anode and L2 is connected to the cathode.
  - ▶ Continuity indication will be off if L1 tip is connected on Cathode of diode and L2 tip on Anode.
  - ▶ Tester automatically switches to voltage measurement if voltage >6V or Single pole is detected during diode testing.

## 7.7 RESISTANCE TEST

 Make sure the object under test is not live.

- Switch into resistance measurement by pressing On/Off-function button repeatedly until the kΩ symbol is shown on LCD. Connect both test probes to the object under test. Resistance up to 100 kΩ can be shown on LCD. For resistance less than ~20Ω buzzer sounds continuously to indicate low continuity.

Tester automatically switches to voltage measurement if voltage >15V or Single Pole is detected.

## 7.8 FREQUENCY TEST

- Switch into frequency measurement by pressing the On/Off-function button repeated until Hz symbol is shown on the LCD. Connect both test probes to the AC voltage under test. Frequency from 1 Hz to 800 Hz can be shown on LCD.

Frequency measurement is possible for voltages >10V AC.

-  The level of voltage will be shown only on bar graph for voltages >120V. ELV diode will indicate voltages >50V AC and >120V DC.

## 7.9 CABLE BREAK DETECTION BY NCV

- Switch into NCV detection by pressing On/off-function button repeatedly. LCD will show the NCV symbol.
- The NCV function is used to find where the cable breaks.
- Hold the voltage tester with the sensor against the wire or cable. The voltage tester indicates the strength of the signal digitally on the LCD screen.
- Store test probes safely to avoid any unintended connection.
- Tester automatically switches to voltage measurement if voltage >6V or single pole is detected between probes.

## 7.10 Torch light

- Press the “torchlight” button to turn on the light and after approx. 30 s it will turn itself off.

## 7.11 Self test

- LEDs and all LCD segments and vibration motor, torch light, ELV indication and buzzer are turned on for a second after battery replacement.

Self test can be activated:

- ▶ Shorting L1 (-) and L2 (+) probe tips while device is turned OFF – leave device OFF for 30 seconds before shorting tips.

## 7.12 HOLD Function

- A long press (2 seconds) of the “torchlight/function” button activates HOLD function and freezes display value. With another quick press of the “torchlight/function” button freezing of display is released. When the HOLD function is active **HOLD** symbol will be shown on LCD.

## 7.13 Backlight

- White Backlight is turned on when torch light is turned on.

## 8.0 BATTERY REPLACEMENT

-  Remove the probes from any testing point, when opening the battery case. Batteries are dead when the continuity test with both test probes connected cannot be done anymore and the low battery symbol is shown in the LCD.

Follow the procedure below and replace batteries with new ones (type IEC LR03 1.5 V).

- Unscrew the battery door
- Pull out the battery door and replace the batteries. Insert new batteries according to the engraving on the battery door.
- Re-assemble battery door.

-  Confirm that the battery door case is properly locked prior to measurements.

## 9.0 TECHNICAL DATA

Voltage Range	1...1000V AC (15...800Hz), 1...1500V DC(±)
LED nominal Voltage	120/230/400/690/1000V
LED tolerances	EN 61243-3
ELV indication LED	>50V AC, >120V DC
Response time	<1s at 100% of each nominal
LCD Range	1...1000V,AC (15...800Hz), 1...1500V DC(±)
LCD Resolution	0.1V (1...29.9V), 1V
LCD Accuracy	±3% ±1.5V (1...29.9V) ±3% ±3dgt (30...1500V)
LCD Overrange indication	"OL"
Current Test	0.1...200A AC(+/-3%+5Dgt) Resolution 0.1A Frequency range 45...65 Hz
Safety current	I <sub>s</sub> <3.5 mA (at 1000V AC), <6 mA at 1500V DC
Measurement Duty	30 s ON, 240 s OFF
Internal battery consumption	approx. 120mA
Single-pole phase test voltage range	100...1000V AC (50/60 Hz)
Phase rotation test	170...1000V phase-to-phase, AC (40...70Hz)
Continuity test	0...500 kΩ + 50%
Resistance measurement	0...100 kΩ; accuracy: ±5%±10dgt@25°C; resolution: 1 Ω (1-2000 Ω) 1 kΩ (2-100 kΩ)
Frequency measurement	1...800 Hz ±5%±5dgt; resolution: 1 Hz
NCV Test	100...1000V AC (50/60Hz)
Battery	3V (IEC LR03 1.5V x 2)
Temperature	-15...55°C operation; -20...70°C storage; No condensation
Humidity	max. 85% RH
Altitude	up to 2000 m
Overvoltage	CAT IV / 600V, CAT III / 1000V
Standard	EN/IEC 61243-3:2014
Protection	IP64

## 10.0 CLEANING AND STORAGE

- ⚠ Tester does not need any special maintenance if used according to user manual.
- ⚠ Remove tester from all test points before cleaning.
- ⚠ Use a lightly damp cloth with neutral detergent for cleaning the instrument. Do not use abrasives or solvents.
- ⚠ Do not expose the instrument to direct sun light, high temperature and humidity or dewfall.
- ⚠ Remove batteries when the instrument will not be in use for a long period.

## WARRANTY

Our instruments are subject to strict quality control. However, should the instrument function improperly during normal use, you are protected by our 2 year warranty (valid with invoice or receipt).

Within the warranty period we will decide whether to exchange or repair the defective instrument. We will repair free of charge any defects in workmanship or materials, provided the instrument is returned unopened and untampered with.

Damage due to dropping or incorrect handling are not covered by the warranty. If the instrument shows failure following expiry of warranty our service department can offer you a quick and economical repair.

Subject to changes without notice.

# KEWTECH

## Certificate of Conformity and Warranty

Product:

**KT5 Current Voltage Detector**

.....

This instrument has been calibrated using equipment which has itself been calibrated to standards traceable to International Standards monitored by BIPM (International Bureau of Weights and Measures).

This certificate guarantees that the product has been fully inspected and conforms to all the relevant published specifications.

### **FREE TWO YEAR GUARANTEE**

Kewtech's Two Year Warranty enhances customers' legal rights. It covers all manufacturing defects for a two year period but Kewtech reserves the right to exclude abuse or accidental damage.

### **RE-CALIBRATION SERVICE**

Regular re-calibration is recommended for this instrument. Kewtech recommends that with normal use the instrument be calibrated at least once in every 12 month period. When the instrument is due for re-calibration return it to the address below marked for the attention of the Calibration Department.

.....

Simply go to [kewtechcorp.com](http://kewtechcorp.com) to register your instrument

Kewtech Corporation Limited  
Unit 2, Shaw Wood Business Park, Shaw Wood Way,  
Doncaster DN2 5TB T: 01494 792 212  
[kewtechcorp.com](http://kewtechcorp.com)