

INSTRUCTION MANUAL

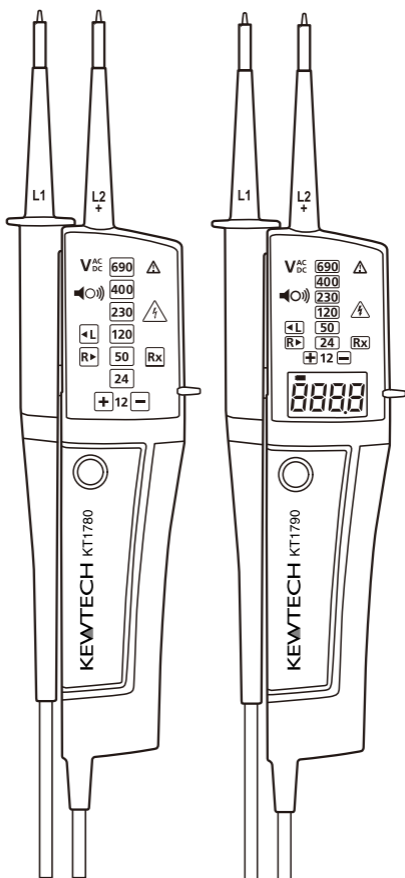

VOLTAGE TESTER

KT1780 / KT1790

KEWTECH

1. Features

- Designed to meet international safety standards. IEC61243-3 / 61010-1 / 61010-031 / 61557-7 Measurement Category (CAT) IV 600V
- Self-Diagnostic test
- AC and DC voltage test up to 690V with LEDs and LCD (only KT1790)
- Polarity indication
- Single-pole phase test
- Phase rotation test
- Continuity test
- Auto-power ON / OFF
- Pen light for illuminating measurement points
- 4mm probe tips (GS38)
- Probe protection cover protects user and test tips
- IP65 (IEC60529)
- Compact design (Light weight and portable)

2. Safety Warnings

This instrument has been designed to be used by skilled persons and in accordance with safe methods of work, and has been designed, manufactured and tested according to IEC 61010/61243: Safety requirements for Electronic Measuring apparatus, and is supplied having passed rigorous quality procedures.



The operating instructions contain information and Cautions required for safe operation and use of the instrument. Before using the instrument, read the operating instructions carefully and follow them in all respects.

Failure to follow the instructions or to comply with warnings and cautions may result in life-threatening injuries to the user and damage to the instrument and/or device under test.

 **WARNING** is reserved for conditions and actions that are likely to cause serious or fatal injury.

 **CAUTION** is reserved for conditions and actions that can cause injury or instrument damage.

Symbols used on the instrument

	User must refer to the explanations in the instruction manual.
	Instrument with double or reinforced insulation, Class II insulation.
	Insulated personnel body protective equipment up to 690V.
CAT. II	Electrical circuits of equipment connected to an AC electrical outlet by a power cord.
CAT. III	Primary electrical circuits of the equipment connected directly to the distribution panel, and feeders from the distribution panel to outlets.
CAT. IV	The circuit from the service drop to the service entrance, and to the power meter and primary overcurrent protection device (distribution panel).
CE	Comply with EMC and Low Voltage Directive.

⚠ WARNING

- Never make measurement on a circuit in which the electrical potential exceeds 690V.
- Do not attempt to make measurement in the presence of flammable gasses, as the use of the instrument may cause sparking, which could lead to an explosion.
- Never attempt to use the instrument if it's surface or your hands are wet.
(Do not use in rainfall.)
- Never unlock and open the Battery case during measurements.
- Verify proper operation on a known source before use or taking action as a result of the indication after use.
- Never attempt to make any measurement if any abnormal conditions, such as a broken case or exposed metal parts are present on the Instrument or test probes.
- Do not make any disassembly or any modification to the instrument.
- Extreme caution when *Live circuit LED* blinks or lights on.
- Correct indication of LEDs is only guaranteed within a temperature range of -15°C up to 55°C (<85% RH).

3. Instrument layout

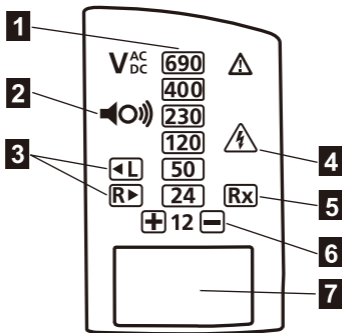

1. 12/24/50/120/230/400/690V LEDs for voltage indication
2. Buzzer
3. L/R LEDs for phase rotation test
4. Live circuit LED for Single-pole phase and Double-pole test
5. Rx LED for Continuity test
6. Polarity indication LEDs
7. LCD (only KT1790)

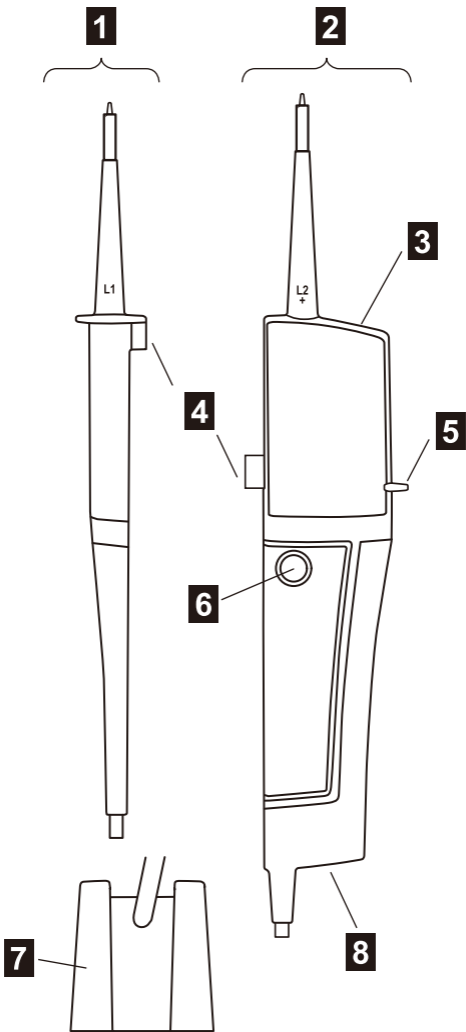

- 1. L1 probe -
- 2. L2 probe + (Instrument probe)
- 3. Pen light
- 4. Probe Clip
- 5. Finger Guard
- 6. Pen light switch
- 7. Probe protection cover
- 8. Battery case

4. Preparation for measurement

4.1 Auto-power-on / Self-diagnostic test

• Auto-power-on

- ▶ Short-circuiting the probes as follows powers on the instrument automatically and goes into a Self-diagnostic test. If the tester is not in sleeping mode, please wait for 10 seconds and carry out the self-diagnostic test.

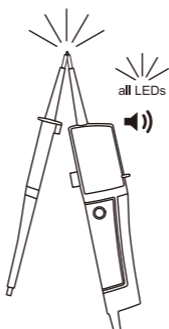

Instrument may power on due to the influence of static charge.

- ▶ When the battery voltage is below $2.4 \pm 0.1V$, Rx LED blinks (and the battery symbol will also light up as for KT1790) which indicates that the battery capacity is low.

• Self-diagnostic test

⚠ WARNING

Do not use the instrument when abnormality is found at Self-diagnostic test.

- ▶ Battery voltage is normal when all LEDs are lighting up and the buzzer is beeping.
 - ▶ When the battery voltage is below approx. 2.6V, L and/or R LEDs will not light up and the Phase rotation test of Clause 5.4 will not operate.
 - ▶ When Rx LED blinks, all the functions except for the double-pole test without batteries of Clause 5.2 will not be guaranteed.
 - ▶ When the necessary functions will not operate, please replace the batteries according to Clause 6.
- Auto-power off
 - ▶ Instrument is automatically powered off after 5 sec when there is no signal contacted to the probes.

Auto-power off may not operate when a significant electric magnetic field exists in the vicinity.

5. Measurement

⚠ WARNING

- Carefully check Clause 2 as well.
- Self-diagnostic test should be done prior to measurements and confirm LED and buzzer works properly.
- Verify proper operation on a known source before and after use even if the Self-diagnostic test is OK.
- Make sure that you can hear the buzzer at locations with a high background noise.
- Keep your hand and fingers behind the finger guards on the probes during measurements.
- Due to the high internal resistance (approx. 200k Ω), capacitive and inductive voltages (interference voltages) may be indicated.
- Make sure that the test probes have good contact. Oxide layers on the device under test may influence the measurement.

5.1 Voltage test (Double-pole test)

- ▶ Connect both probes to the device under test.
- ▶ The voltage is indicated by LEDs and LCD (only KT1790).

Live circuit LED lights up and Buzzer sounds when the threshold voltage of 50V LED is exceeded.

- ▶ Voltage polarity is indicated in following manner.

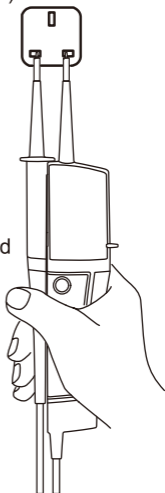

12V LED lights up when exceeds 7V (Threshold voltage of 12V LED).

AC



+DC



-DC



12V LED blinks at below approx. 7V (AC only)

AC



NOTE

- This instrument can make measurements between L-PE without tripping RCDs.
- When the L2 probe + is the positive (negative) potential, the Polarity indication LED indicates "+DC" ("-DC").
- L/R LED may light up.

5.2 Double-pole test without batteries

Respective LEDs light up even when double-pole test carried out without batteries.

Only the threshold voltage of the 12V LED changes to approx. 12V or more.

The threshold voltage of other LEDs (24/50/120/230/400/690V) are according to the Specification. (See Clause 7)

5.3 Single-pole phase test

⚠ WARNING

- Carefully handle L1 probe – when it is not in use.
 - Function of this test may not be fully achieved:
 - :if the insulation condition of user or of the device under test is not sufficient.
 - :if the device under test contains much high frequency component which exceeds 60Hz.
- Verification of live-circuit shouldn't be dependent on this Single-pole phase test only, but also on the Double-pole test. (See Clause 5.1.)

- ▶ Hold the instrument firmly and connect the L2 probe + to the device under test.
- ▶ *Live circuit LED* lights up and buzzer sounds when a voltage of approx. 100V AC or more exists in the device under test.

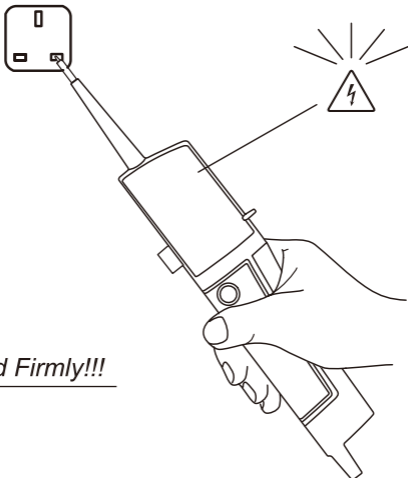

5.4 Phase rotation test

L LED and *R LED* for Phase rotation test may operate on various wiring systems, but effective testing result can be obtained only on Three-phase 4-wire system.

- ▶ Hold the instrument firmly and connect both probes to the device under test.
- ▶ Phase-to-phase voltage is indicated by each Voltage LED.
- ▶ *R LED* lights up for Right rotary field.

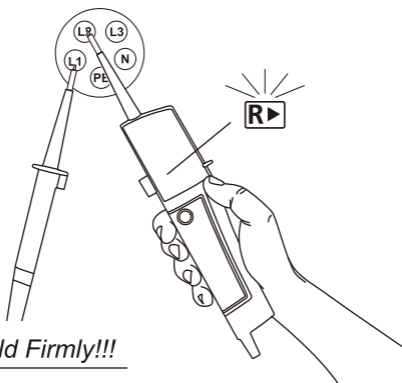

- ▶ *L LED* lights up for Left rotary field.

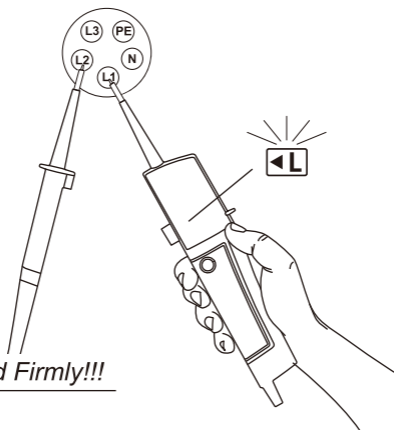

The principle of measurement

The instrument detects the phase rising order regarding the user as EARTH.

NOTE

Function of this test may not be fully achieved
:if the insulation condition of user or of the device under test is not sufficient.
:if the device under test contains much high frequency component which exceeds 60Hz.

5.5 Continuity test

⚠ WARNING

Make sure the device under test isn't live.

- ▶ *Rx LED* lights up and buzzer should sound continuously.

5.6 Pen light function

(Illuminating the Measurement Point)

Pen light illuminates the measurement point in dimly lit area

- ▶ Pressing the Pen light switch to turn on the light and after (10s) it will turn itself off.

NOTE

- Using the Pen light shortens the battery life.

6. Battery Replacement

⚠ WARNING

Remove the probes from any testing point, when opening the Battery case.

Follow the procedure below and replace batteries with new ones (type IEC LR03 1.5V).

- ▶ Unlock the Battery case with a coin-shaped object.

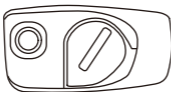

Lock

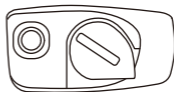

Unlock

- ▶ Pull out the Battery case and replace the batteries. Insert new batteries according to the engraving on the Battery case.
- ▶ Insert the Battery case into the instrument and firmly lock the case again.

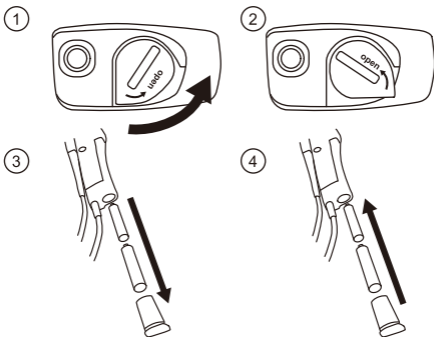

⚠ WARNING

Confirm that the Battery case is properly locked prior to measurements.

7. Specification

Voltage test	
Voltage range	12...690V AC/DC
Peak current	$I_s < 3.5\text{mA}$ (at 690V)
Measurement Duty	30s ON (operation time) 240s OFF (recovery time)
Internal battery consumption	Approx. 80 mA (battery 3V, measuring 690V AC)
Battery life	Approx. 1000 operations (30s ON / 240s OFF duty)
LED (KT1780 / KT1790)	
Nominal voltage	12/24/50/120/230/400/690V AC (16...400Hz), DC(\pm)
Tolerance (Threshold voltage)	Light on at more than : $7\pm 3\text{V}$ (12V LED) : $18\pm 3\text{V}$ (24V LED) : $37.5\pm 4\text{V}$ (50V LED) : $75\%\pm 5\%$ of nominal voltage (120/230/400/690V LED)
Response time	$< 0.6\text{s}$ at 100% of each nominal voltage
LCD (only KT1790)	
Range / Resolution (Auto-range)	300V (6.0...299.9) / 0.1V 690V (270...759ac/710dc) / 1V
Accuracy (23 \pm 5 $^{\circ}\text{C}$)	$\pm 1.5\text{V}$ (7...100V) $\pm 1\%\pm 5\text{dgt}$ (100...690V) AC(16...400Hz), DC(\pm)
Over limit indication	"OL"
Response time	$< 1\text{s}$ at 90% of each voltage
Single-pole phase test	
Voltage range	100...690V AC (50/60Hz)
Phase rotation test	
System	Three-phase 4-wire system 200...690V phase-to-phase (100...400V earth-to-phase) AC 50/60Hz
Phase range	120 ± 5 degree
Continuity test	
Detection range	0...400k Ω + 50% (23 \pm 5 $^{\circ}\text{C}$)
Test current	Approx. 1.5 μA (battery 3V, 0 Ω)
Internal battery consumption	Approx. 80 mA (battery 3V, 0 Ω)
Reference condition	
Battery	3V (IEC LR03 1.5V x 2)
Temperature	-15...55 $^{\circ}\text{C}$ operation (-15...50 $^{\circ}\text{C}$ Self-diagnostic test) -20...70 $^{\circ}\text{C}$ storage No condensation
Humidity	Max 85% RH
Used location	Altitude up to 2000m
Safety	
Standard	IEC(EN)61010-1:2010(2010) IEC(EN)61243-3:2009(2010) IEC(EN)61010-031:2008(2008) IEC(EN)61557-7:2007(2007)
Category	CAT.III 690V, CAT.IV 600V
Pollution degree	2
IP code	IP65 (IEC60529)

Size	
Dimensions	243 x 64 x 26mm
Weight	190g (including batteries)

8. Cleaning and storage

CAUTION

- Use a lightly damp cloth with neutral detergent for cleaning the instrument. Do not use abrasives or solvents.
- Do not expose the instrument to direct sun light, high temperature and humidity or dewfall.
- Put the Probe protection cover on the Tips while not in use. Otherwise it may cause an injury.
- Remove batteries when the instrument will not be in use for a long period.

9. For Environment



This instrument is subject to WEEE Directive (2002/96/EC).

Please contact your nearby KEWTECH dealer for disposal.

KEWTECH reserves the rights to change specifications or designs described in this manual without notice and without obligations.

KEWTECH

Kewtech Corporation Ltd
Unit 2, Shaw Wood Business Park
Shaw Wood Way
Doncaster
DN2 5TB
Tel: 01302 761044
Web: www.kewtechcorp.com

KEWTECH

Certificate of Conformity & Warranty Registration

This instrument has been calibrated using equipment which has itself been calibrated to standards traceable to International Standards monitored by BIPM (International Bureau of Weights and Measures)

This certificate guarantees that the product has been fully inspected and conforms to all the relevant published specifications.

Free Two Year Warranty

Kewtech's Two Year Warranty enhances the customers' legal rights. It covers all manufacturing defects for a two year period but Kewtech reserves the right to exclude abuse or accidental damage.

To register your free guarantee simply go to www.Kewtechcorp.com, the link is on the home page.

Re-calibration Service

Regular re-calibration is recommended for this instrument. Kewtech recommends that with normal use the instrument is calibrated at least once in every 12 month interval.

When the instrument is due for re-calibration return it to the address below marked for the attention of the Calibration Department.

Kewtech Corporation Ltd.

Shaw Wood Business Park, Shaw
Wood Way, Doncaster, DN2 5TB
Tel: 01302 761044