



LED LITE™
Energy Saving LED

LTFB10

10W Slim LED FLOODLIGHT

NEW Ultra Slim COB LED Floodlights for exterior/interior, maintenance free, energy saving - 70% / 80% running cost savings compared to incandescent lamps

Applications Include: Gardens, Bushes/Shrubs, Security Lighting, Porch Lighting and Area Floodlighting, Site Lighting

- Voltage Range: 220-240VAC
- Nom. Watts: 10w
- Lumens: 680 lumens
- Beam Angle: 120°
- IP Rating: IP65
- Warranty: 3 Year
- Optional PVC Inground Garden Spike 1 per Fitting
- Shatter Resistant Tempered Glass
- Die Cast Aluminium Casing
- Not Dimmable
- Adjustable Bracket



Dimensions:

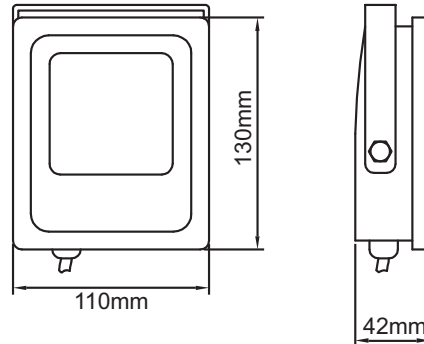

Available colours:

Product Code	Description
LTFB10A	LED Flood Light 10W Amber
LTFB10B	LED Flood Light 10W Blue
LTFB10G	LED Flood Light 10W Green
LTFB10R	LED Flood Light 10W Red
LTFB10WW	LED Flood Light 10W Warm White
LTFB10CW	LED Flood Light 10W Cool White
LTFB10CC	LED Flood Light 10W Colour Changing

IP65

**680
lumens**

These high performance LED's are of outstanding performance and quality and not to be confused with cheaper budget leds on sale!

10W Slim LED COB Flood Light Photometric Data:

Spectrum Power Distribution Chart:

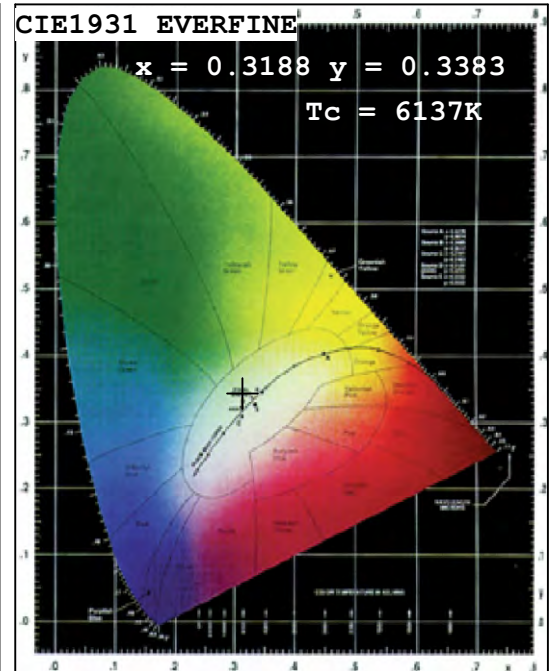
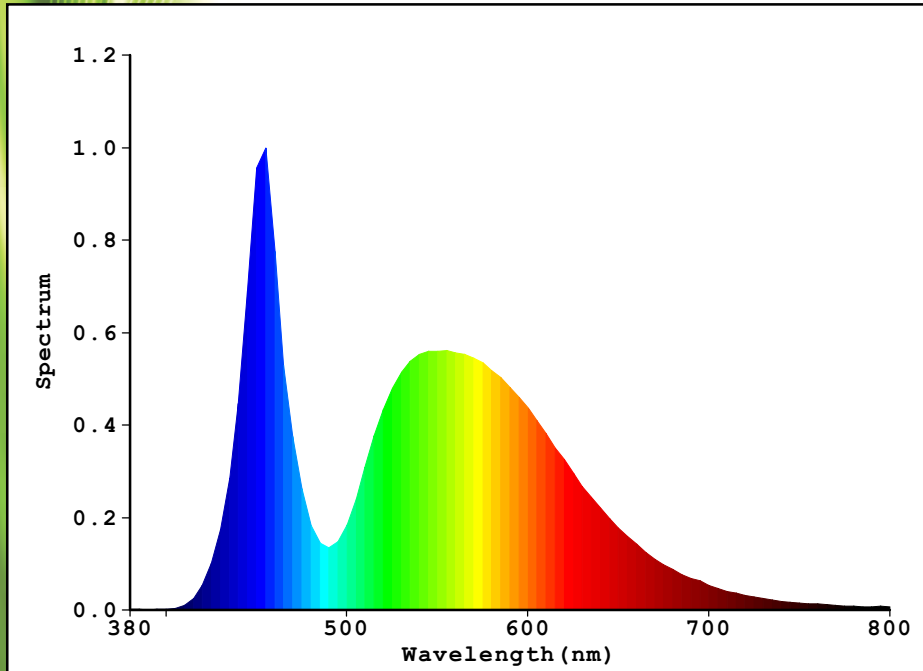

Spectrum:		
λ (Peak WL):	455.0 nm	I(test): 0.05714 A
λ (Dominant WL):	496.1 nm	V(Positive): 220.2 V
λ (Centroid WL):	545.0 nm	Power: 10.28 W
BandWidth:	24.8 nm	Power Factor (PF): 0.8649
Colour Temp(Tc):	6137 K	Luminous Flux: 681.58 lm
Colour Coordinate (x,y):	x=0.3188 y=0.3383 (dx=-0.0008; dy=0.0088)	Light Efficacy: 66.3 lm/w
Colour Coordinate (u',v'):	u'=0.1986 v'=0.4741 (duv=4.94e-03)	Render Index (Ra): 83.2
Colour Purity:	4.6%	R1 =80 R2 =88 R3 =91 R4 =82 R5 =80
Light Power(Fe):	2.0764 W	R6 =79 R7 =94 R8 =70 R9 =-17 R10 =56
RGB Ratio:	R=13.6% G=82.4% B=4.0%	R11 =77 R12 =49 R13 =82 R14 =98 R15 =77



LEDLITE™
Energy Saving LED