

LEDLITE™ User Instructions

LTLPS9/LTLPW9 - 9W LED LoPro9 Light

IP44  220-240V

Please read these instructions before commencing installation & retain them for future reference.

Important information

It is recommended that the fittings are installed by a qualified electrician ensuring the installation complies with current IEE wiring regulations & local building control.

- These products are designed for connection to a 220-240V mains supply.
- We cannot accept responsibility for any claims arising from a poor installation.

Important User Advice

- Always switch off mains supply before installation.
- This luminaire is suitable for indoor use only and should not be fitted to damp or wet surfaces such as freshly plastered or painted walls.



CAUTION! Hot Surface. Do Not Touch.

The surface of the LoPro9 becomes hot when the light is on. Please allow time to cool down completely before handling.

Dimensions:

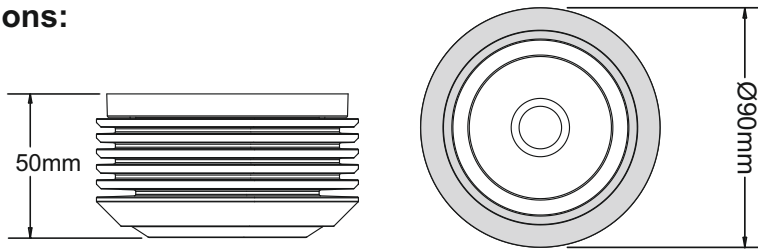

Specifications:

- Voltage Range: 220-240VAC
- Nom. Watts: 9W
- Light Output: 765± Lumens
- LED Colour: 3000/4000/6000K
- Power Factor > 0.90
- CRI > 80
- Beam Angle: 120°
- Dimmable with selected dimmers
- Body Colour: Polished White / Silver
- Material: Aluminium Alloy Body & PC Lens
- IP Rating: IP44

Installation:

 **Warning!** Switch off the power source before installation & maintenance

Tools required:



Pencil

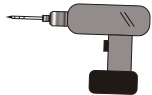

Electric drill

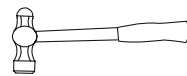

Hammer



Screwdriver

Step 1: Identify the location and direction of any hidden supply cables or service pipes before drilling fixing holes.

Step 2: Mark the position of the fixing holes onto the wall/ceiling surface adjacent to the supply wiring (Fig.1).

Step 3: Drill holes at the positions marked and fit the plastic wall plugs (Fig.2).

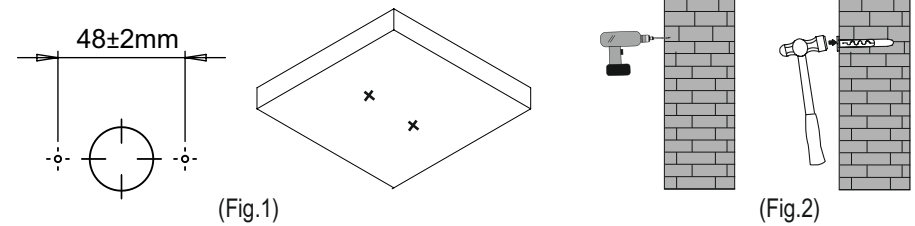

Step 4: Screw the plastic base of the light fitting onto the wall/ceiling (Fig.3). Connect the lamp wires to the base using the plugs (Fig. 4) and the mains wires as in the wiring diagram below and tighten the terminal screws securely.

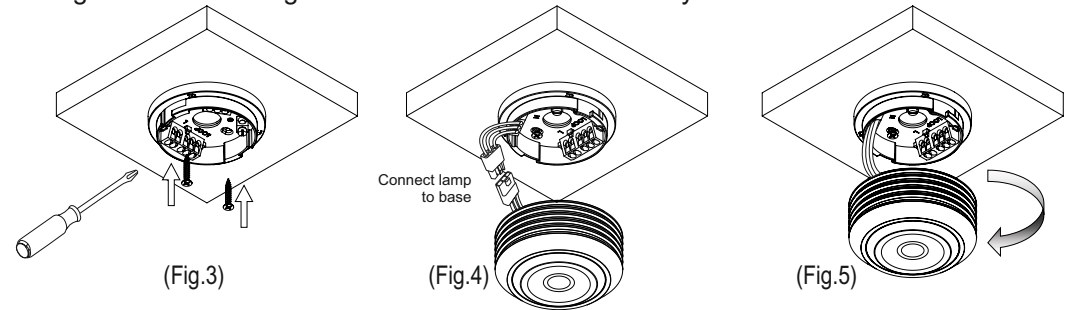

Step 5: Mount the light body onto the plastic base by screwing it clockwise until it snaps into place (Fig.5). Inspect the unit to ensure secured installation. Switch the mains power on to test for correct operation.

Wiring Diagram:

Live  Brown
Neutral  Blue
Earth  Green/Yellow

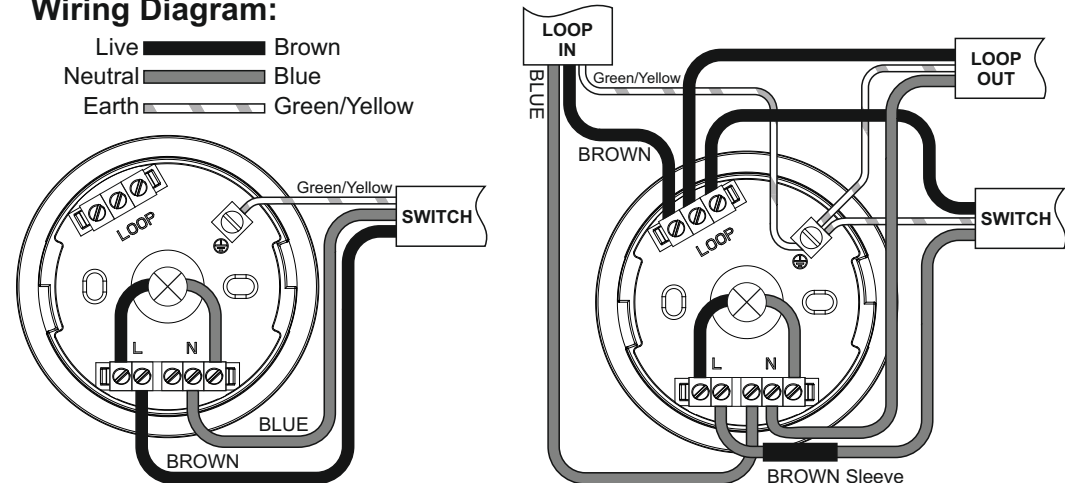

Standard Circuit

Looping Circuit

For further information visit www.tlc-direct.co.uk