

Product selected: Coolfit 50W/12V 60°

A sealed front low voltage (12V) halogen lamp with an aluminium reflector and clear flat front lens. Heat and light are dissipated forward, reducing fixture/ceiling discolouration making Coolfit the perfect choice for use in small ceiling voids or where no rear light spillage is wanted.

Applications

- Accent lighting in retail, commercial and domestic applications where heat dissipation towards the back of the lamp is not acceptable
- Can replace any 12V 50 mm diameter dichroic low voltage lamp
- Suitable for use in open ceilings or in luminaires featuring the lamp

Features

- Heat and light are dissipated forward away from the back of the lamp
- Sealed flat front lens protects capsule and reflector from dust, and offers extra safety
- Wear resistant aluminium reflector for constant light output and colour temperature throughout lamp life
- Dimmable using a suitable dimmer for operation with a transformer
- Constant colour and light output throughout lamp life
- Excellent colour rendering
- Easily recognisable by blue cement in lamp cap
- The use of UV-Stop materials dramatically reduces UV emissions
- Average rated life: 5000 hours

Product Image

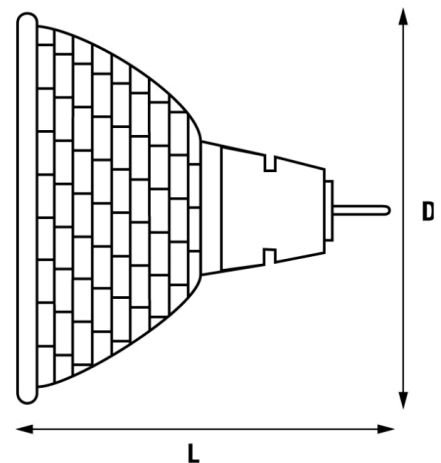
Line Drawing

Product Attributes

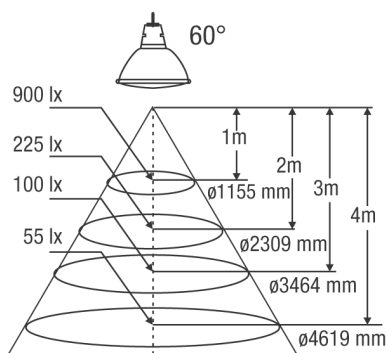
Item description	Coolfit 50W/12V 60°
Ordering Code	0022520
EAN code	5410288225203
Packing Quantity	100
Wattage (W)	50
Voltage (V)	12
Cap	GX/GU5.3
Max. Over. Length (mm)	49
Diameter (mm)	51
Average life (hours)	5000
Colour Temp (K)	3000
Beam angle(°)	60
Peak intensity (CD)	900

UV Stop
UV STOP
Illuminance Diagram
Coolfit - 50W/60°

Lamp Cap
