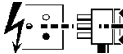

Slimlite

Installation Instructions for: (221mm) - LL6071 LL6072 LL6073 (284mm) - LL6075 LL6076 LL6077 + LL6508 LL6509

SAFETY

Follow the appropriate national wiring regulations. If in any doubt contact a qualified Electrician.

 Disconnect from Mains supply before installation, Maintenance or replacing the lamp.

Lamps reach maximum temperatures rapidly. Take care when adjusting, relamping or cleaning.

SLI Lighting accepts no responsibility for modified products or for the affects of cleaning solvents or for the accumulation of dust or dirt. Do not interconnect Class III products with Class I or Class II. Unless otherwise marked, products are IP20(ordinary). Do not use in Damp or Corrosive situations.





All products are suitable for use in ambient temperatures of 25° C. The products should not be covered with any heat insulating material, air flow around the fitting should not be restricted. Note minimum distances to adjacent surfaces. Any enclosure which prevents normal heat dissipation may cause reduced performance, overheating or risk of fire. (see Installation Instructions for recommendations).

These products should be connected to the lighting circuit, or fused at a maximum of 5A. If a dimmer is installed it must be specifically rated as suitable for the equipment used.

After completing the installation note the suppliers name, address and purchase date and hand this leaflet to the person responsible for lighting maintenance, for future reference.

Follow these instructions carefully to ensure safe and reliable operation. Retain this leaflet for future reference. In case of any queries contact your supplier.

The following symbols may be found on the product or labels:

-  -Class I. This fitting Must be Earthed and Equipotentially bonded.
-  -This fitting is suitable for mounting on Normally Flammable surfaces.
-  -Indicates the safest minimum distance of lamp from a flammable surface.
-  -Class II Double insulated. This fitting must not be Earthed.
-  -Class III. Low Voltage (SELV).

Throughout these instructions the following coding may be used:

- Line (L) - Brown or Red.
- Neutral (N) - Blue or Black.
- Earth (⊕) - Green/Yellow or Bare Conductor

All Dimensions are in Millimetres

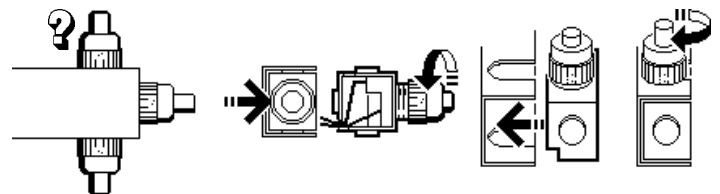
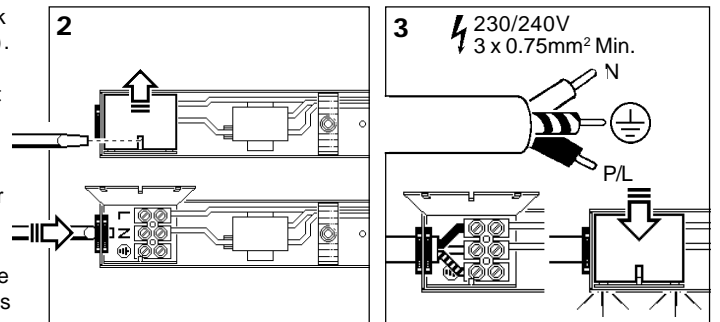
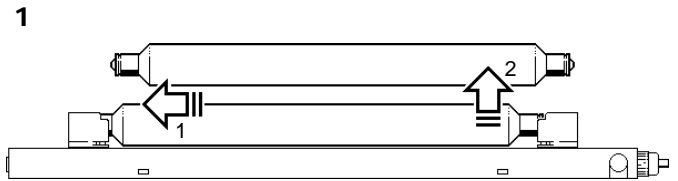
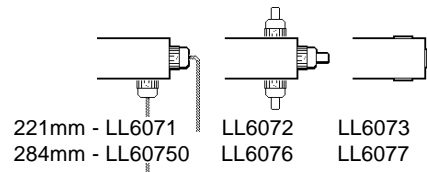
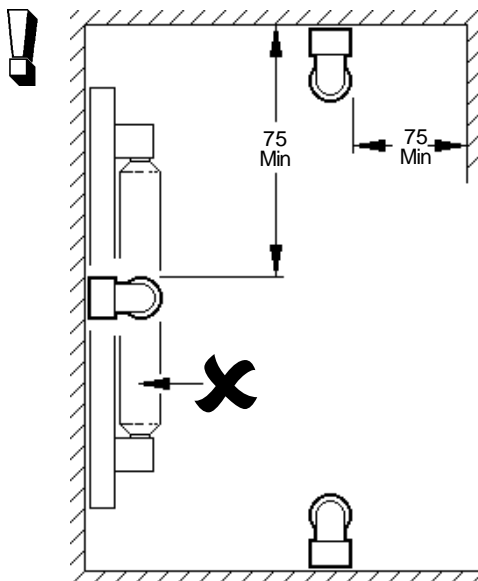

221mm - LL6508
284mm - LL6509

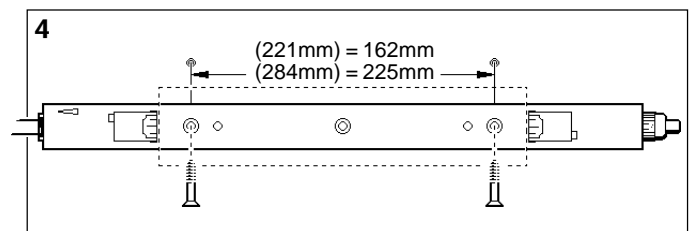
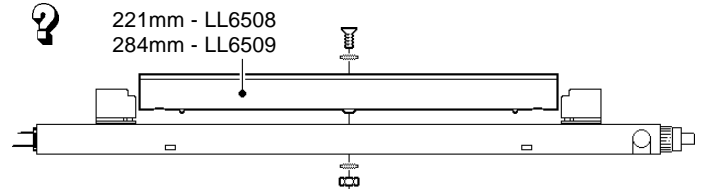

5 (221mm) 30/60W Max. 221mm Tungsten S15s Opal
(284mm) 30/60W Max. 284mm Tungsten S15s Opal

