

TX500 Wireless PIR Detector

For Lighting Control and CCTV



2a Bellevue Road, Friern Barnet, London N11 3ER
T. 020 8368 7887 F. 020 8368 3952
info@luminite.co.uk

Product Overview

The TX500 Wireless Detectors are battery operated (PP 3 type) and have the same appearance as their GX200 hard wired low voltage counterparts.

This VHF wireless PIR detector has a transmission range of up to 1Km line of sight if used with an RX16DC receiver and AE173 aerial. Day time operation can be inhibited if required. Compatible receivers are:

RXB plug in bleeeper with built in receiver.

RX300 lighting control unit with built in receiver.

RX400 receiver for use with DX100 lighting control unit.

RX16 CCTV interface receiver with up to 16 outputs.

RX16DC long range version of the RX16.

The TX500 has been DTI approved and is license exempt. For use in the UK only.



Available Detection Patterns

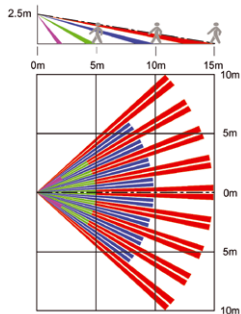

TX500/15 -
15m Medium range

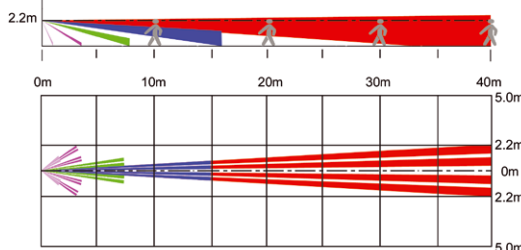

TX500/40 -
40m Narrow range

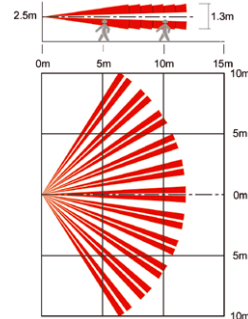

TX500/HC -
12m Horizontal Curtain

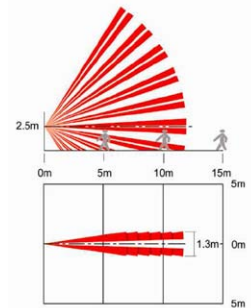

TX500/VC -
12m Vertical Curtain

Lighting Control Installation

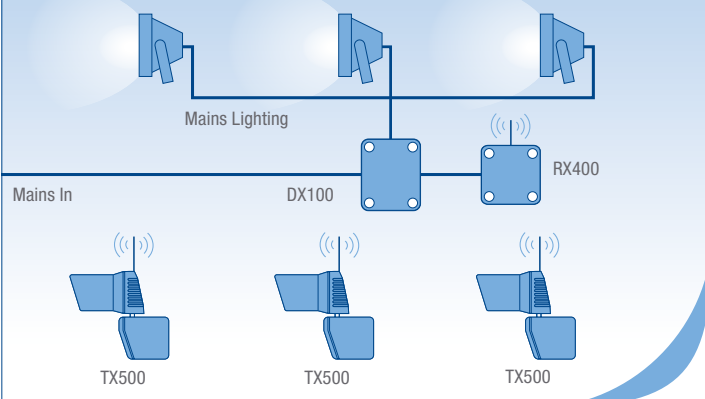

CCTV Control Installation

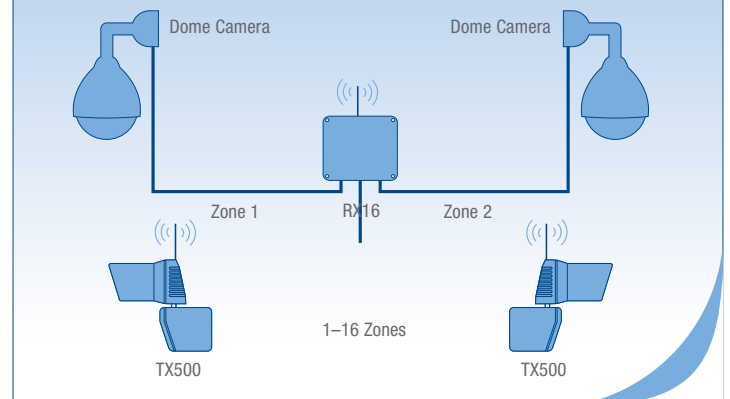

For Use With TX500



RX400 Single Zone Wireless Receiver (requires DX100)



RX16 16 Zone Wireless Receiver



RX16DC Long Range 16 Zone Wireless Receiver



RX300 240v Wireless Receiver for Lighting Control



RXB Mains Powered Plug-in Wireless Receiver & Bleeper

For more information see separate datasheets

Dimensions

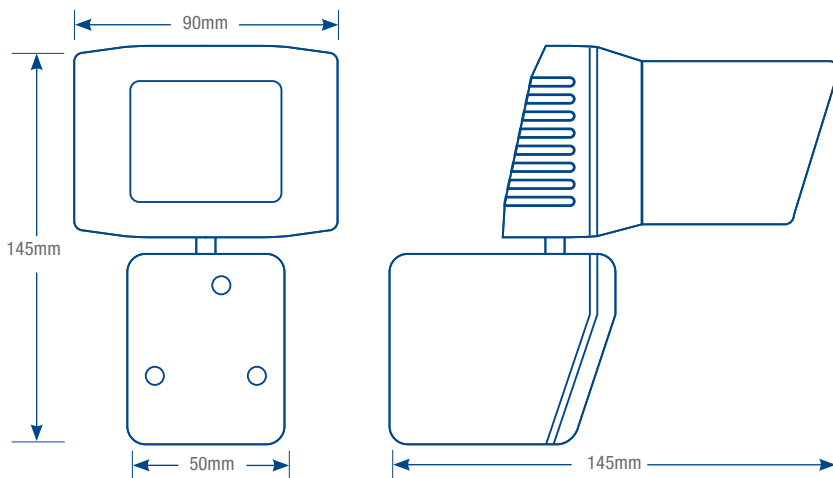

Specifications

Supply	9 volt battery (PP 3) type. Use alkaline long life type or lithium
Battery life	Approx. 36 months (depending on situation) Battery life approx 50,000 transmissions Alkaline or 100,000 Lithium.
Transmitter power	10 milli-watt with external ariel
Frequency	173.225 Mhz (VHF MPT 1344)
Modulation	Pulse modulation AM
Site Codes	32
Unit Codes	16 Use them with the RX16 and RX16DC receivers
Siting	Can be mounted in horizontal or vertical modes and adjusted to various angles
Detection	Passive Infrared
Coverage Options	15m Medium range 40m Narrow range 12m Horizontal Curtain 12m Vertical Curtain
Range	Up to 1000 metres depending on receiver
Ambient light control	Built in light sensor for use with DX100, RX300 and RXB
Temperature range	-10 to +50°C
Weather Rating	IP56
Enclosure	Durable ABS UV stabilised housing. Colour grey. Optional colours: white or black.

