



LUXAIRTM
EXTRACTION WITH ATTRACTION

LA-ORBIT



Reducer Collar reduces the motor exhaust from 150mm to 125mm if required (Already supplied in box)

Please note this hood must be installed on a minimum of 125mm Ducting

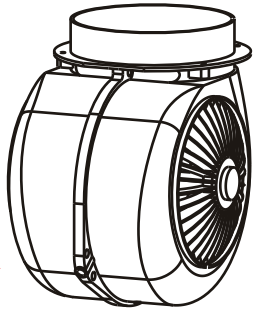

Spare Motor 480 m³/hr
- Fits Models 60cm + 90cm

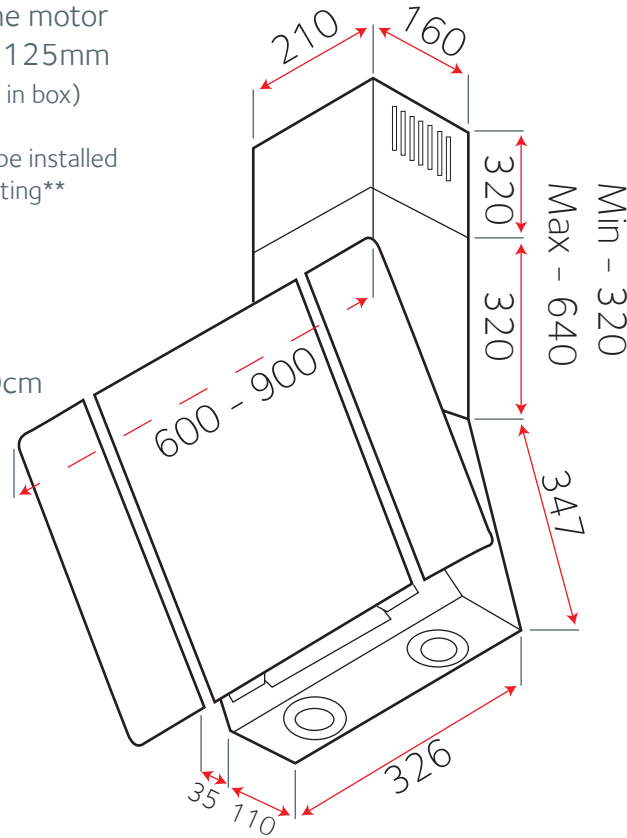

Replacement Switch Push Button

Please Contact Luxair For More Details As This Is A New Type Of Switch

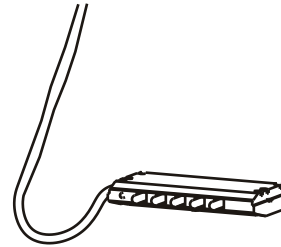

Transformer - 1



-2x Halogen Fittings (All Models)



Mesh Grills (current Models)

LA-60-Orbit x1 222x250
LA-90-Orbit x2 222x250

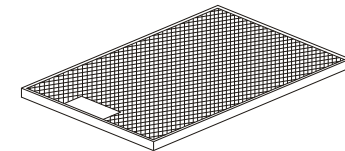

Please note you must measure your mesh grill size. Older models will have different sizes to current models

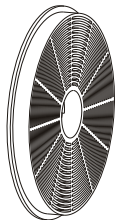
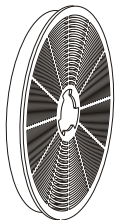
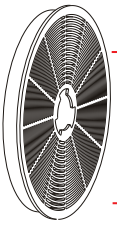

2x Charcoal Filter Round 1

(2 Filters Per Pack, 1 either side of Motor)