

Please note the motor can be turned 360 degrees so that the exhaust can face any direction

6" - 180 x 95 Ducting

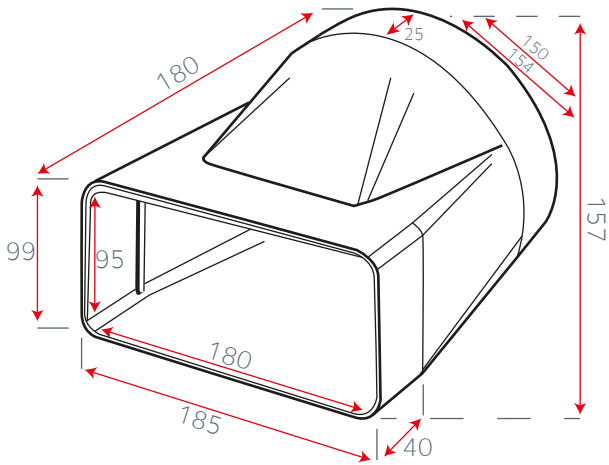

Ducting - Our slimline motor is designed with a rectangular ducting system. Please note as this ducting is rectangular and not round, it will have different dimensions.

Our rectangular ducting is 180mm x 95mm

Please remember this hood must be installed on a minimum 6" ducting. If you are using rectangular ducting, this must be a minimum of 180mm x 95mm

Cut Out 1275mm x 675mm
Ducting Size 180mm x 95mm

