

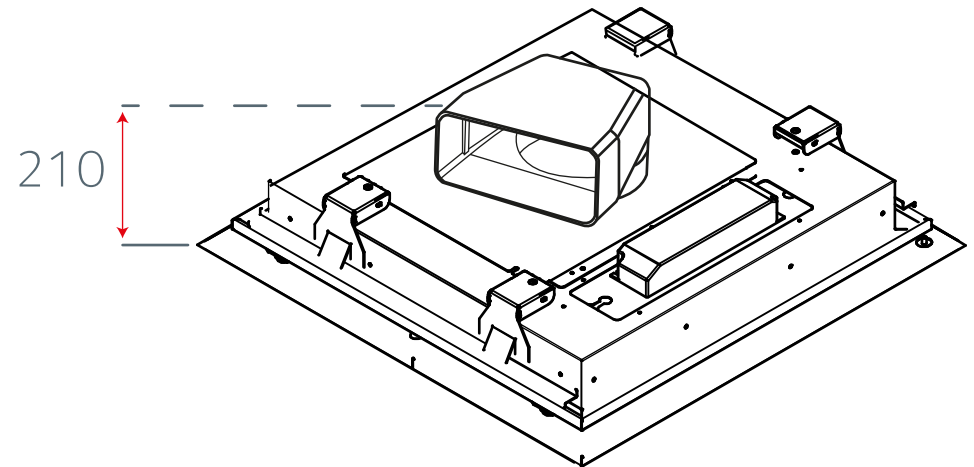

LUXAIR™
EXTRACTION WITH ATTRACTION

LA-60-Tolvi External Motor

6" - 180 x 95 Ducting

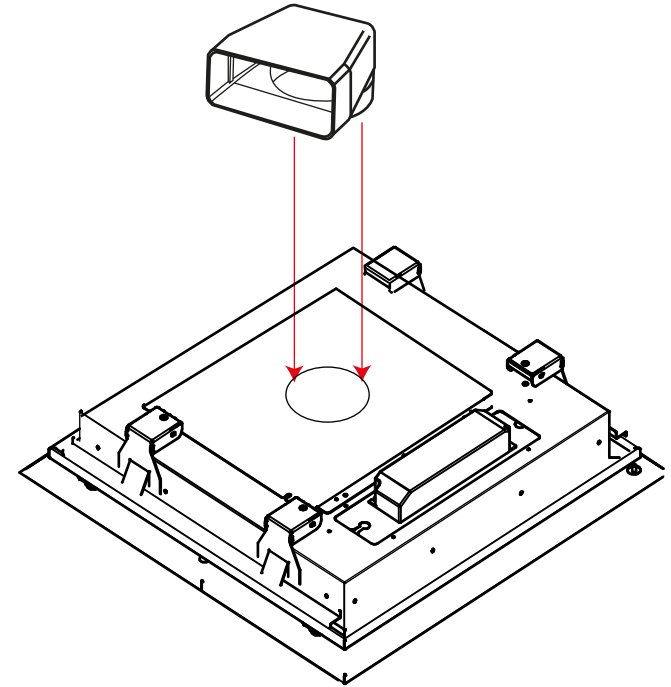
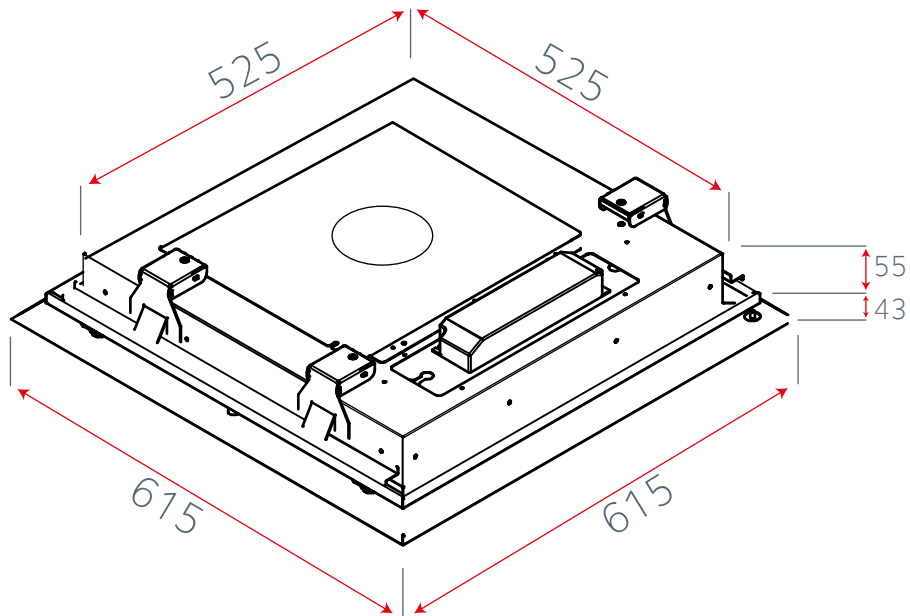
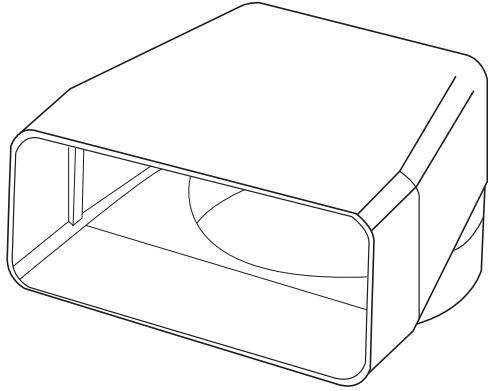

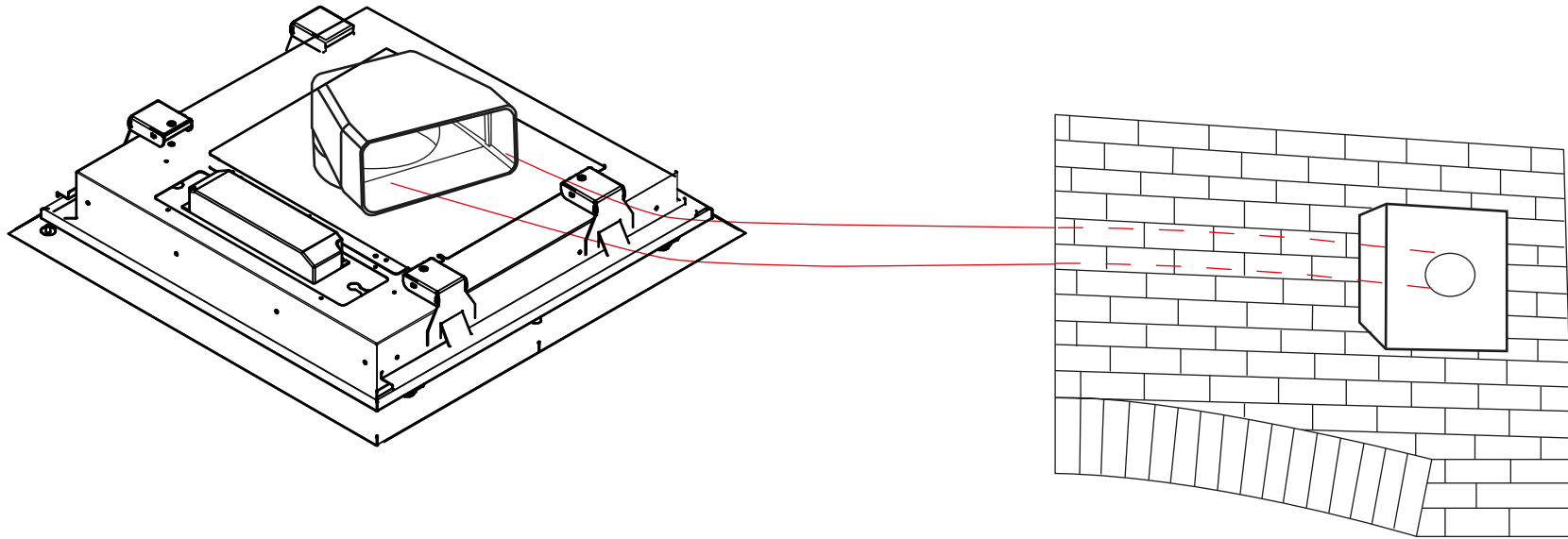

Wall Mounted External Motor

Pitched Roof External Motor

Flat Roof External Motor

