



## MASTERColour CDM-TC 35W/830 G8.5 1CT

### Product family description

Range of single-ended, very compact, high-efficiency, discharge lamps with a stable colour over lifetime and a crisp, sparkling light

### Product Features

- Warm or cool white colour impression with good colour rendering
- Allows very small-size luminaire designs that give high beam intensities

### Product Benefits

- Long lamp life compared with incandescent and halogen lamps
- UV-Block quartz outer bulb for reduced fading risks
- Stable colour impression over lifetime
- High lamp efficacy results in low operating costs and low heat generation (which enhances comfort for shoppers and staff)

### Environment

- Good environmental choice because of high energy efficiency and long reliable life
- This product is RoHS compliant
- This product is covered by WEEE

### Application

- Sparkling effect, ideal for accent lighting
- General and decorative lighting

### Luminaires

- Must be used in closed luminaires with a hard-glass cover

### System

- Preferably used with electronic gear, which offers minimum system volume, increases lamp-life, improves system efficacy, and offers flicker-free operation
- A high-current protection device (thermo-switch) in the gear is mandatory (IEC 1167)

Product data	
Order code	200006 15
Full product code	871150020000615

Product data	
loccod	
Full product name	MASTERCcolour CDM-TC 35W/830 G8.5 1CT
Order product name	MASTERC CDM-TC 35W/830 G8.5 1CT/12
Packing type	1 Lamp in a Folding Carton
Pieces per pack	1
Packing configuration	12
Packs per outerbox	12
Bar code on pack - EAN1	8711500200006
Bar code on intermediate packing - EAN2	
Bar code on outerbox - EAN3	8711500200013
Logistic code(s) - 12NC	9280 852 05125
ILCOS code	MT-35/30/1A-H-G8.5
Net weight per piece	0.010 KG
Successor order code	
Cap-Base	G8.5
Bulb	T14 [T 14mm]
Bulb Material	UV-Block Quartz
Bulb Finish	Clear
Burning Position	any [Any/Universal]
Life to 5% failures	- hr
Life to 10% failures	- hr
Life to 20% failures	- hr
Life to 50% failures	- hr
Life to 50% failures EM	10000 hr
Life to 50% failures EL	12000 hr
Life to 10% failures EM	8000 hr
Life to 5% failures EL	6000 hr
Life to 5% failures EM	6000 hr
Life to 20% failures EL	9000 hr
Life to 20% failures EM	9000 hr
Life to 10% failures EL	8000 hr
Rated Lamp Wattage	35W
Lamp Wattage EM	38.0 W
Lamp Wattage EL	38 W
Lamp Voltage	88 V
Lamp Current EM	0.53 A
Lamp Current EL	0.47 A
Dimmable	no
Mercury (Hg) Content	3 mg
Colour Code	830 [CCT of 3000K]
Colour Rendering Index	81 Ra8
Colour Designation	Warm white
Colour Temperature	3000 K
Chromaticity Coordinate X	432 -
Chromaticity Coordinate Y	394 -
Lamp Luminous Flux EM	3300 Lm
Lamp Luminous Flux EL	3100 Lm
Lamp Luminous Efficacy EM	87 Lm/W
Lamp Luminous Efficacy EL	- Lm/W
Lumen Maintenance 2000h	- %
Lumen Maintenance EM 2000h	70 %
Lumen Maintenance EL 2000h	80 %
Lumen Maintenance 5000h	- %
Lumen Maintenance EM 5000h	55 %

Product data	
Lumen Maintenance EL 5000h	65 %
Lumen Maintenance 10000h	- %
Lumen Maintenance EM 10000h	35 %
Lumen Maintenance EL 10000h	50 %
Lumen Maintenance 12000h	- %
Bulb Temperature	500 C



MASTERC CDM-TC 35W/830/842/942

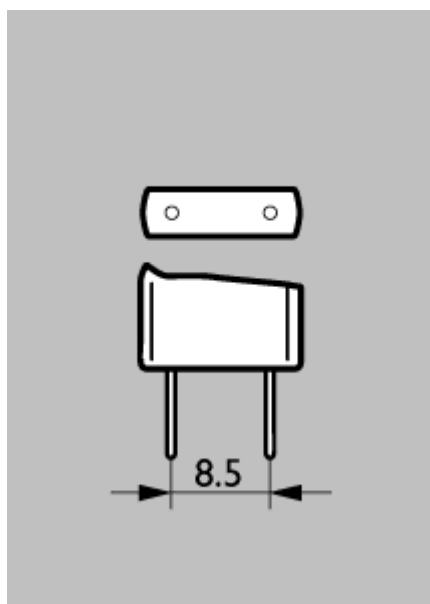

Cap-Base G8.5

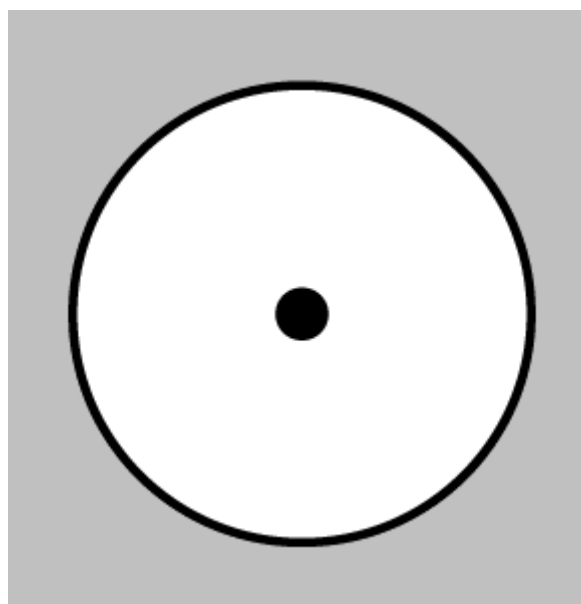

Burning Position any

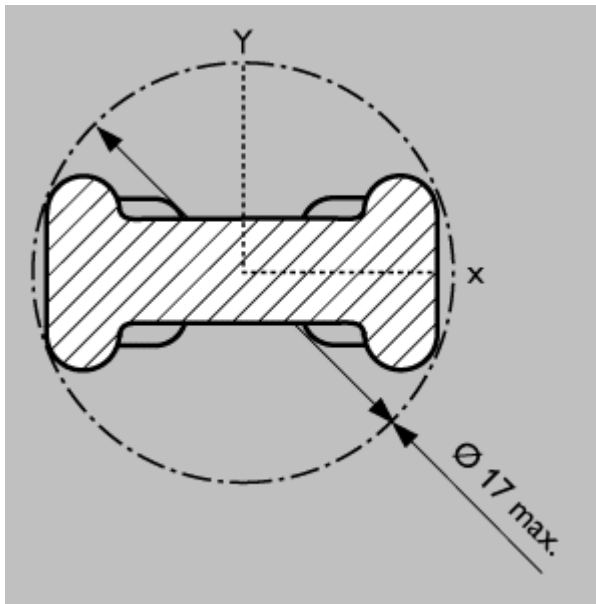

MASTERC CDM-TC

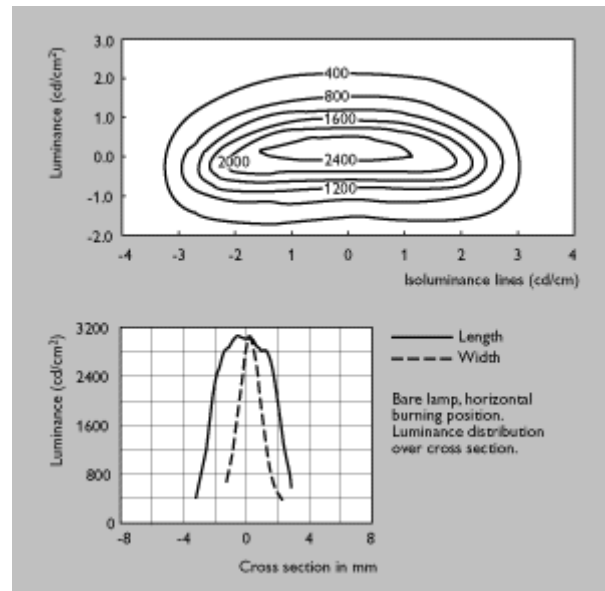

MASTERC CDM-TC 35W

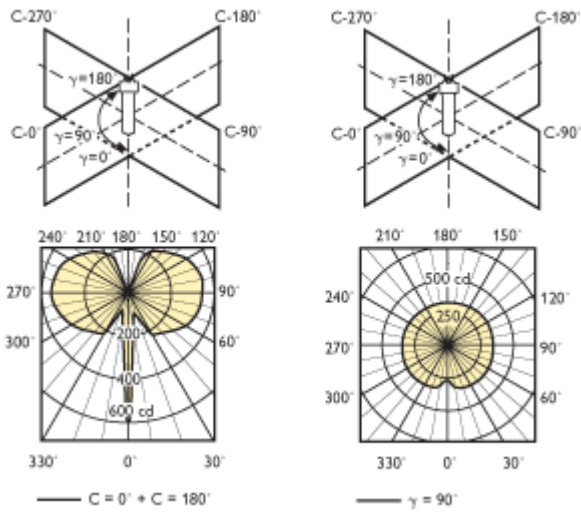

MASTERC CDM-TC 35W/830

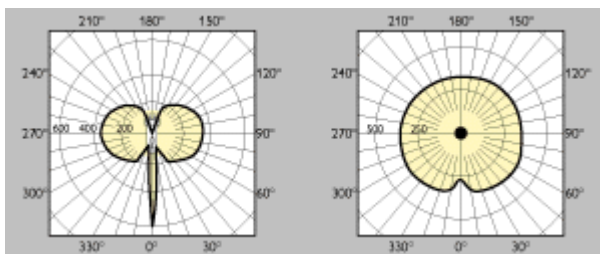

MASTERC CDM-TC 35W/70W/830

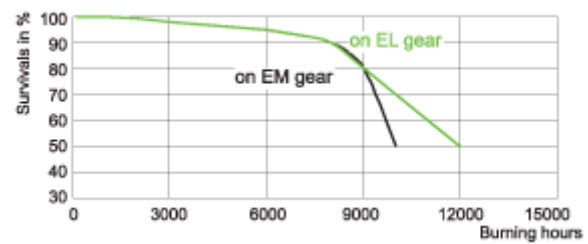

on electronic & electromagnetic gear

MASTERC CDM-TC 35W/830

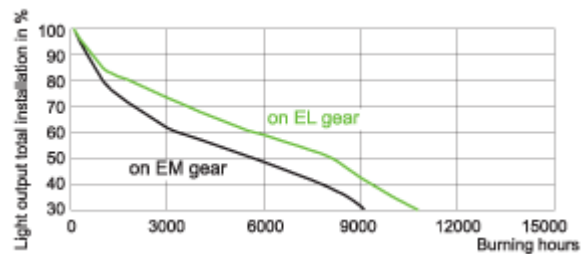

on electronic & electromagnetic gear  
 MASTERC CDM-TC 35W/830

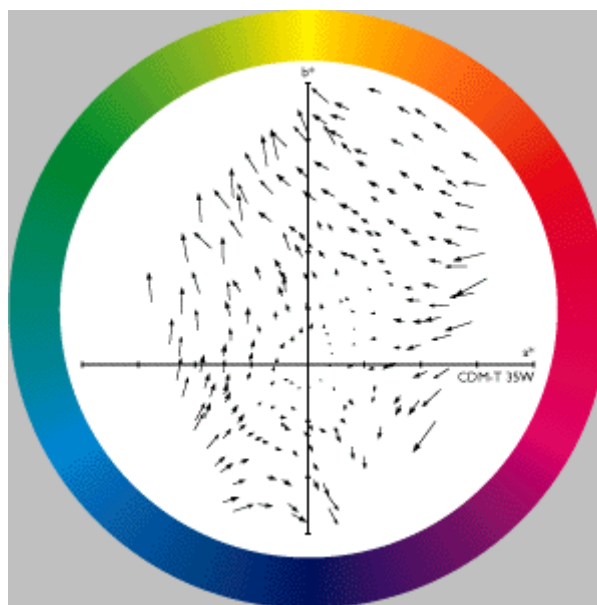

MASTERC CDM-TC 35W/830

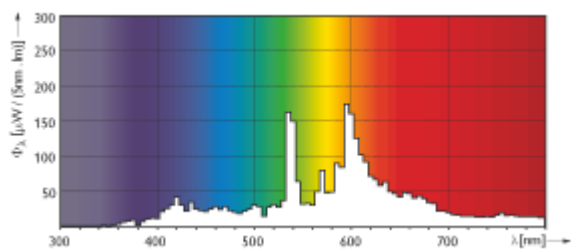

MASTERC CDM-TC/830

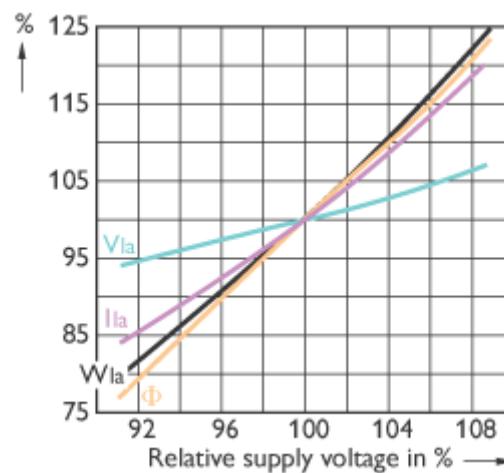

MASTERC CDM-TC 35W/70W/830

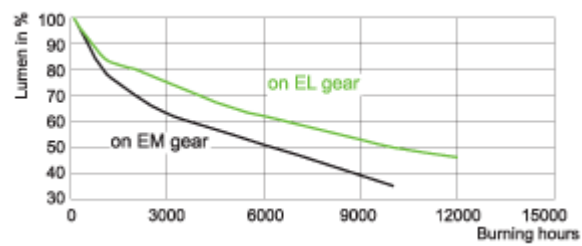

on electronic & electromagnetic gear

MASTERC CDM-TC 35W/830

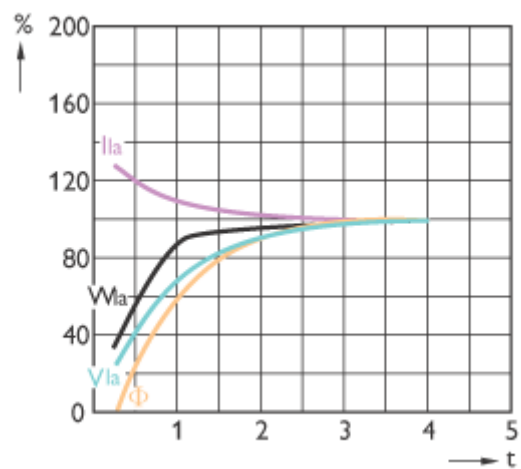

MASTERC CDM-TC 35W/70W/830/842/942

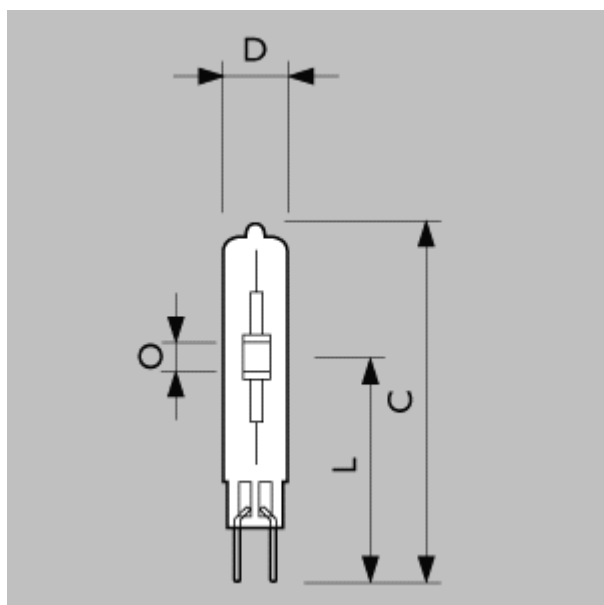

MASTERC CDM-TC

	C	C	D	D	L	L
Full product name	Max	Max	Max	Max	Min	Min
MASTERCour CDM-TC 35W/830 G8.5 ICT	85	85	15	15	51	51

	L	L	L	L	O	O
Full product name	Nom	Nom	Max	Max	Min	Min
MASTERCour CDM-TC 35W/830 G8.5 ICT	52	52	53	53	4.69	4.69

---

	O	O	O	O
Full product name	Nom	Nom	Max	Max
MASTER Colour CDM-TC 35W/830 G8.5 ICT	4.9	4.9	5.11	5.11

---

