

QR305

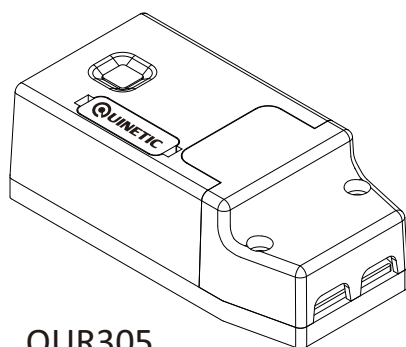

Controller for Quinetic Wireless Switch

Installation Instructions



QR305

Read all instructions before installation

Specifications

Controller for Quinetic Wireless Switch Technical Specifications:

Voltage range: 85-260V 50/60Hz
Working environment temperature: -25°C - 50°C
Control distance*: 160m(outdoor), 30m(indoor)
Control method: pairing with Quinetic Wireless Switch (see instructions)

Control Load: 16A
Maximum Load: 1000W LED & 3kW other loads**

*Distance comes from Quinetic laboratory test results. The actual distance in practical use might vary due to environmental difference.

**Maximum load rating may vary depending on manufacturers specifications.

Wireless receiving controller installation

1. Ensure that the power is turned off before installation.
2. The wireless receiver/controller line input should be connected using live and neutral cable from mains.
3. Output lines should be connected to load using cable rating suitable for 85-260V depending on voltage at site. (see diagram below).
4. Use the double-sided adhesive tape or screw to fix the wireless receiving controller.

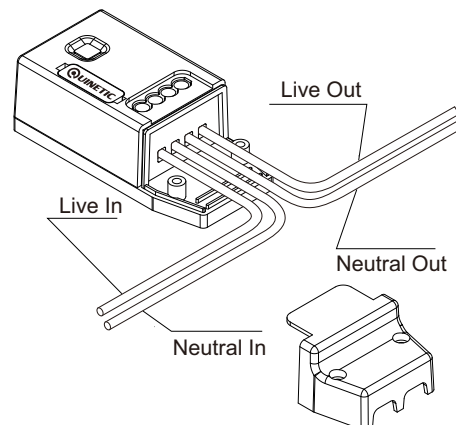

Wiring Instructions

Wireless receiving controller code pairing method *

Wireless Quinetic energy switch and wireless receiving controller can be paired with any combination: a controller can be controlled by a maximum of 10 separate switches, a switch can pair an unlimited number of controllers. The range of a switch may also be extended by putting the controller in to the " Bridging Mode".

Code pairing steps:

1. Press the function button for 3 seconds and the indicator light begins to flash slowly. Then release the button and enter the single pairing state.
2. Press the wireless kinetic energy switch and the indicator light of the controller will go out, which means that the pairing is successful.
3. If you need to add more switches to the same controller, please repeat the above process; each controller can store up to 10 switches, pairing in formation.
4. Single, double and triple switches follow the same pairing method.
5. In order to put the controller in to Bridging mode press the function button for 7 seconds. The indicator light will pulse continuously to indicated a succesful "bridge".
6. If the controller indicator light continues to pulse the controller will still function normally even if used with a single switch.
7. To remove the controller stored pairing information press function button for 10 seconds until the indicator light goes out - the pairing information will be removed.

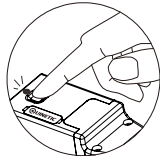

Press for 3 seconds to enter program mode

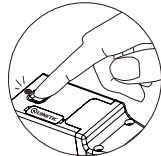

Press for 10 seconds to clear memory

Precautions:

1. The wiring must be done in accordance with the method of installation illustrated.
2. Please note the maximum loading of an individual controller. Exceeding this maximum will result in blowing the fuse.
3. Do not short-circuit, otherwise it will cause permanent damage to the receiving controller.
4. Damage caused by incorrect installation and operation are not covered under warranty.

Troubleshooting:

1. If pairing does not work first check if the indicator is lit. Re-pair in case the pair is lost after power failure.
2. If the receiver does not respond check the LED indicator. If this does not light check the power supply, if present the fuse may need replacing(see below)
 - Turn power off and remove fuse as shown below.
 - Replace with a fuse of the same specification and put it back in the controller.
 - Turn the power back on and press the function button to check LED lights.
 - Replacing the fuse does not affect the original pairing setting.

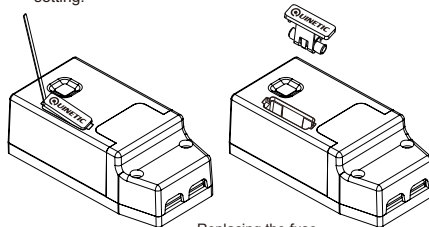

Replacing the fuse

Controller for Kinetic Wireless Switch

QR305

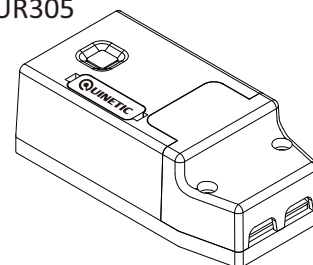

Dimensions:

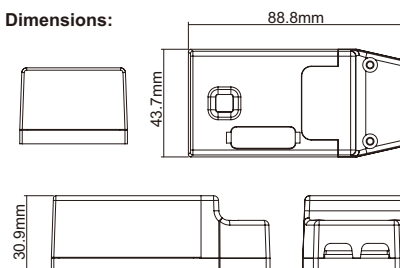

*Please note: For more pairing information visit www.tlc-direct.co.uk