



DIGITAL MULTIMETER
600.219
600.524

Gebbruiksaanwijzing

Instruction Manual

Mode d'Emploi

Gebrauchsanleitung

Brugsanvisning

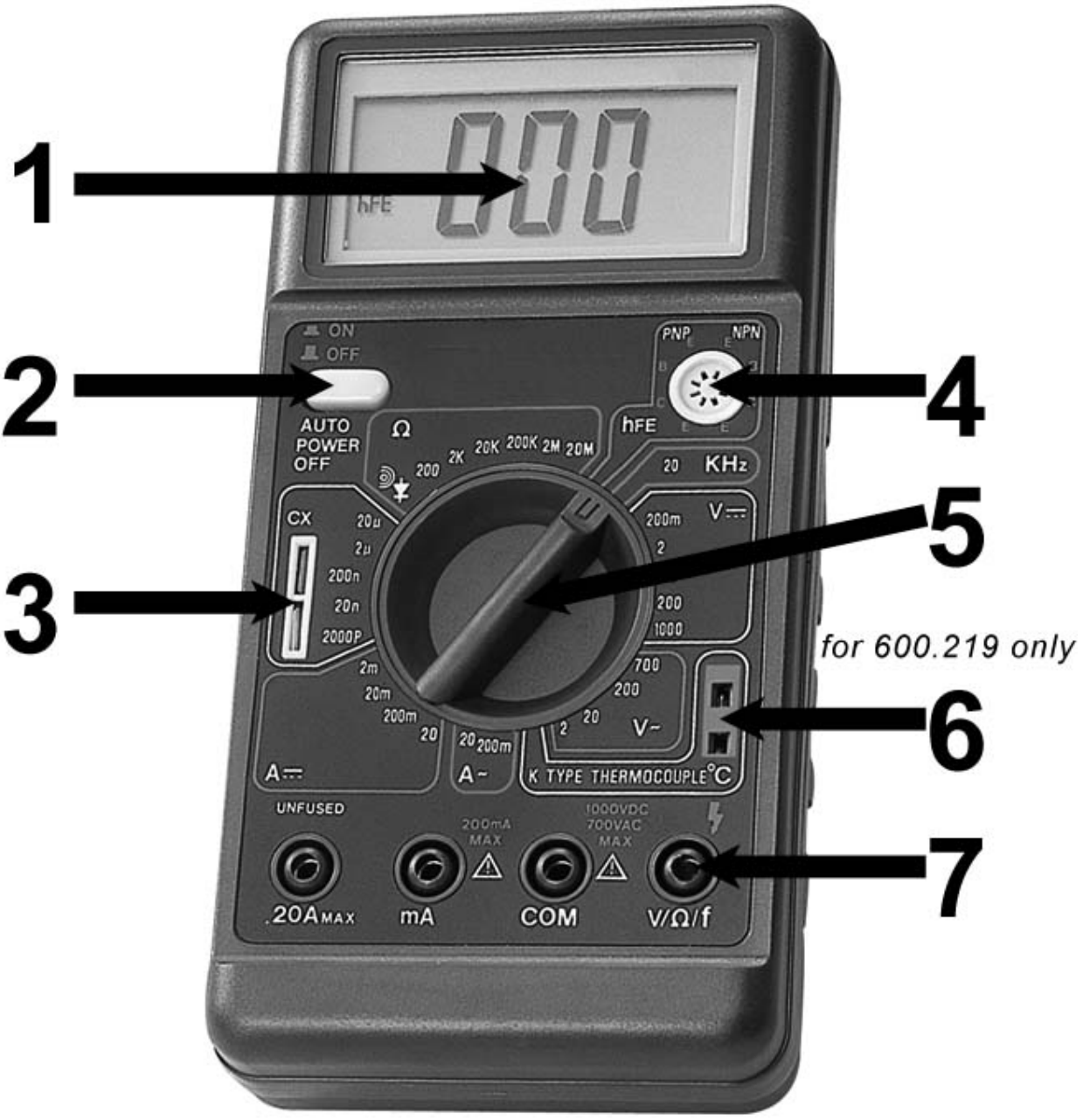

Read this owner's manual thoroughly before use.

SAFETY INFORMATION

The digital multimeter has been designed according to IEC-1010 concerning electronic measuring instruments with an over voltage category (CATI) and pollution degree 2.

ELECTRICAL SYMBOLS



AC (Alternating Current)



DC (Direct Current)



Important safety information. Refer to the manual.



Dangerous voltage may be present.



Earth ground



Fuse



Conforms to European Union directives

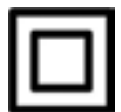

Double insulated

*Do not attempt to make any repairs yourself. This would invalid your warranty.
Do not make any changes to the unit. This would also invalid your warranty.
The warranty is not applicable in case of accidents or damages caused by
inappropriate use or disrespect of the warnings contained in this manual.
SkyTronic UK cannot be held responsible for personal injuries caused by a
disrespect of the safety recommendations and warnings. This is also applicable to
all damages in whatever form.*

WARNING

To avoid possible electric shock or personal injury, follow these guidelines:

- Do not use the meter if it is damaged. Before you use the meter, inspect the case. Pay particular attention to the insulation surrounding the connectors
- Inspect the test leads for damaged insulation or exposed metal. Check the test leads for continuity. Replace damaged test leads before you use the meter.
- Do not use the meter if it operates abnormally. Protection may be impaired. When in doubt, have the meter serviced.
- Do not operate the meter around explosive gas, vapor, or dust.
- Do not apply more than the rated voltage, as marked on the meter, between terminals or between any terminal and earth ground.
- Before use, verify the meter's operation by measuring a known voltage.
- When servicing the meter, use only specified replacement parts.
- Use with caution when working above 30V AC RMS, 42V peak, or 60V dc. Such voltages pose a shock hazard.
- When using the probes, keep your fingers behind the finger guards on the probes.
- Connect the common test lead before you connect the live test lead. When you disconnect test leads, disconnect the live test lead first.
- Remove the test leads from the meter before you open the battery door.
- Do not operate the meter with the battery door or portions of the cover removed or loosened.
- To avoid false readings, which could lead to possible electric shock or personal injury, replace the batteries as soon as the low battery indicator (") appears.

CAUTION

To avoid possible damage to the meter or to the equipment under test, follow these guidelines:

- Disconnect circuit power and discharge all high-voltage capacitors before testing resistance, continuity, diodes, or capacitance.
- Use the proper terminals, function, and range for your measurements.
- Before measuring current, check the meter's fuses and turn power OFF to the circuit before connecting the meter to the circuit.
- Before Function/Range switch to change functions, disconnect test leads from the circuit under test.
- Before attempting to insert transistors for testing, always be sure that the test leads have been disconnected from any measurement circuits.
- Remove test leads from the Meter before opening the Meter case.

MAINTENANCE

- Before opening the case, always disconnect the test leads from all live circuits.
- For continue protection against fire, replace fuse only with the specified voltage and current ratings: F 250mA/250V (Fast Blown) ø5 x 20 (F2A/250V (Fast Blown) ø5 x 20 for 600.524)
- Periodically wipe the case with a damp cloth and mild detergent. Do not use abrasives or solvents.

FRONT PANEL DESCRIPTION

1. LCD
2. Power Switch
3. Capacitor Measuring Socket
4. Transistor Testing Socket
5. Function Range Switch
6. Temperature Measuring Socket (For 600.219 only)
7. Input Jacks

GENERAL SPECIFICATIONS

Maximum Display: 1999 counts (3 ½ Digits) with automatic polarity indication

Indication Method: LCD display

Measuring Method: Dual-slope integration A/D converter system

Ovrange Indication: Only figure "1" displayed on the LCD

Reading Rate: 2-3 times/second (approximate)

Operating Temperature: 0°C~40°C (32°F~104°F), <75% R.H.

Storage Temperature: -10°C~50°C (14°F~122°F), <75% R.H.

Power Supply: One 9-volt battery (NEDA1604, 6F22)

Low Battery Indication: "⊕ ⊖" displayed on the LCD

Dimensions: 88 x 173 x 40 (mm)

Weight: 340g (including one 9V battery)

TECHNICAL SPECIFICATIONS

Accuracy is specified for a period of one year after calibration and at 18°C~28°C(64°F~82°F) with relative humidity up to 75%.

Accuracy specifications take the form of:

\pm ([% of Reading]+[Number of Least Significant Digits])

DC VOLTAGE

<i>RANGE</i>	<i>RESOLUTION</i>	<i>ACCURACY</i>
200mV	100 μ V	\pm (0.5% rdg +2D)
2000mV	1mV	
20V	10mV	
200V	100mV	
1000V	1V	\pm (1.0% rdg +2D)

Input impedance: 10M Ω for all ranges

AC VOLTAGE

<i>RANGE</i>	<i>RESOLUTION</i>	<i>ACCURACY</i>	
		600.219	600.524
200mV	0.1mV	/	\pm (1.2% rdg+2D)
2V	1mV	\pm 0.8% rdg \pm 3D	
20V	10mV		
200V	100mV		
700V	1V	\pm 1.5% rdg \pm 3D	

Input impedance: 10M Ω for all ranges

Frequency: 40Hz~1000Hz (40Hz~100Hz for 200V and 750V ranges)

Indication: Average (rms of sine wave)

DC CURRENT

RANGE	RESOLUTION	ACCURACY	
		600.219	600.524
200 μ A	0.1 μ A	/	
2mA	1 μ A		$\pm 0.8\%$ rdg+1D)
20mA	10 μ A		
200mA	100 μ A		$\pm(1.2\%$ rdg+1D)
2A	1mA	/	
20A	10mA		$\pm(2.0\%$ rdg+5D)

Overload protection:

600.219: 250mA/250V fused (Range 20A unfused)

600.524: 2A/250V fused (Range 20A unfused)

Maximum input current: 20A (can not last for more than 10 seconds)

Measuring Voltage Drop: 200mV

AC CURRENT

RANGE	RESOLUTION	ACCURACY	
		600.219	600.524
200 μ A	0.1 μ A		$\pm(1.2\%$ rdg +3D)
2mA	1 μ A	/	
20mA	10 μ A		
200mA	100 μ A		$\pm(1.8\%$ rdg+3D)
2A	1mA	/	
20A	10mA		$\pm(3.0\%$ rdg+7D)

Overload protection:

600.219: 250mA/250V fused (Range 20A unfused)

600.524: 2A/250V fused (Range 20A unfused)

Maximum input current: 20A (can not last for more than 10 seconds)

Indication: Average (RMS of sine wave)

Max. Voltage Drop: 200mV

RESISTANCE

<i>RANGE</i>	<i>RESOLUTION</i>	<i>ACCURACY</i>
200Ω	0.1Ω	±(1.0% rdg+3D)
2KΩ	1Ω	±(0.8% rdg+2D)
20KΩ	10Ω	
200KΩ	100Ω	
2MΩ	1KΩ	
20MΩ	10KΩ	±(1.2% rdg+2D)

Open circuit voltage: less than 700mV.

FREQUENCY (For 600.219 only)

<i>RANGE</i>	<i>RESOLUTION</i>	<i>ACCURACY</i>
20KHz	10Hz	±(1.0% rdg+1D)

CAPACITANCE (For 600.219 only)

<i>RANGE</i>	<i>RESOLUTION</i>	<i>ACCURACY</i>
2000pF	1pF	±(1.0% rdg+5D)
20nF	10pF	
200nF	100pF	
2μF	1nF	
20μF	10nF	

Measuring Voltage: Approximate 40mV RMS.

TRANSISTOR hFE TEST



<i>RANGE</i>	<i>hFE</i>	<i>TEST CURRENT</i>	<i>TEST VOLTAGE</i>
PNP & NPN	0 ~ 1000	$I_b \approx 10\mu A$	$V_{ce} \approx 2.8V$

TEMPERATURE (For 600.219 only)

<i>RANGE</i>	<i>Temperature Range</i>	<i>RESOLUTION</i>	<i>ACCURACY</i>
TEMP.	0°C ~ 400°C	1°C	±(1.5% rdg+3°C)
	400°C ~ 1000°C	1°C	±(1.5% rdg+15°C)

Note: Use “K” type thermocouple probe while measuring temperature.

DIODE AND AUDIBLE CONTINUITY TEST

<i>Range</i>	<i>Description</i>	<i>Test Condition</i>
	The approx. forward voltage of the diode under test will be displayed on the LCD.	The forward DC current is approx. 1mA, the reversed DC voltage is approx. 2.8V.
	If the resistance of the circuit under test is less than 30Ω, the built-in buzzer will sound.	Open circuit voltage approx. 2.8V.

OPERATING INSTRUCTION

DC VOLTAGE MEASUREMENT

- 1) Connect the red test lead to the "V/Ω" jack and the black test lead to the "COM" jack.
- 2) Set the Function / Range switch to the desired "V" range. If the voltage to be measured is not known beforehand, set the range switch to the highest range and then turn down range by range until satisfactory resolution is obtained.
- 3) Connect the test leads to the source or load to be measured.
- 4) Read the voltage value displayed on the LCD along with the polarity of the red test lead.

DC VOLTAGE MEASUREMENT

- 1) Connect the red test lead to the "V/ Ω " jack and the black test lead to the "COM" jack.
- 2) Set the Function / Range switch to the desired " ∇ " range. If the voltage to be measured is not known beforehand, set the switch to the highest range and then turn down range by range until satisfactory resolution is obtained.
- 3) Connect the test leads to the source or load to be measured.
- 4) Read the voltage value displayed on the.

DC CURRENT MEASUREMENT

- 1) [600.219]
Connect the black test lead to the "COM" jack and the red test lead to the "mA" jack (While the current to be measured is between 200mA and 20A, remove the red test lead to the "20A" jack.)
[600.524]
Connect the black test lead to the "COM" jack and the red test lead to the "2A" jack (While the current to be measured is between 2A and 20A, remove the red test lead to the "20A" jack.)
- 2) Set the Function / Range switch to the desired " ∇ " range. If the current to be measured is not known beforehand, set the switch to the highest range and then turn down range by range until satisfactory resolution is obtained.
- 3) Open the circuit in which the current is to be measured, and connect the test leads in series with the circuit.
- 4) Read the current value displayed on the LCD along with the polarity of the red test lead.

DC CURRENT MEASUREMENT

- 1) [600.219]
Connect the black test lead to the "COM" jack and the red test lead to the "mA" jack (While the current to be measured is between 200mA and 20A, remove the red test lead to the "20A" jack.)
[600.524]
Connect the black test lead to the "COM" jack and the red test lead to the "2A" jack (While the current to be measured is between 2A and 20A, remove the red test lead to the "20A" jack.)
- 2) Set the Function / Range switch to the desired "A" range. If the current to be measured is not known beforehand, set the switch to the highest range and then turn down range by range until satisfactory resolution is obtained.
- 3) Open the circuit in which the current is to be measured, and connect the test leads in series with the circuit.
- 4) Read the current value displayed on the LCD.

RESISTANCE MEASUREMENT

- 1) Connect the red test lead to the "V/ Ω " jack and the black test lead to the "COM" jack.
- 2) Set the Function / Range switch to the desired Ω range.
- 3) Connect the test leads to the resistor to be measured and read the value displayed on the LCD.

Note:

- For resistance about 1M Ω and above, the meter may take a few seconds to stabilize. This is normal for high resistance readings.

CAPACITANCE MEASUREMENT

- 1) Set the Function / Range switch to the desired Cx range.
- 2) Before inserting the capacitor to be measured into the capacitance measuring socket, be sure that the capacitor has been fully discharged.
- 3) Insert the capacitor to be measured into the capacitance measuring socket.
- 4) Read the capacitance value displayed on the LCD.

DIODE TEST

- 1) Connect the red test lead to "V/ Ω " jack and the black test lead to the "COM" jack (The polarity of the red test lead is positive "+")
- 2) Set the Function / Range switch to "" range.
- 3) Connect the red test lead to the anode of the diode to be tested and the black test lead to cathode of the diode. The approximate forward voltage drop will be displayed on the LCD. If the connection is reversed, only figure "1" will be shown.

AUDIBLE CONTINUITY TEST

- 1) Connect the red test lead to "V/ Ω " and the black test lead to the "COM" jack.
- 2) Set the Function / Range switch to "" range.
- 3) Connect the test leads to two terminals of the circuit to be tested. If the resistance is less than about 30 Ω , the built-in buzzer will sound.

TRANSISTOR TEST

- 1) Set the Function / Range switch to "hFE" range.
- 2) Determine whether the transistor to be tested is NPN or PNP, and locate the E, B, C leads. Insert the leads into the proper holes of the hFE socket on the front panel.
- 3) Read the approximate hFE value at the test condition of base current 10 μ A and Vce 2.8V.

FREQUENCY MEASUREMENT (For 600.219 only)

- 1) Set the Function / Range switch to the "KHz" range.
- 2) Connect the black test lead to the "COM" jack and the red test lead to the "V/ Ω " jack.
- 3) Connect the test leads to the source or load to be measured.
- 4) Read the frequency value displayed on the LCD.

TEMPERATURE MEASUREMENT (For 600.219 only)

- 1) Insert the K type probe to the temperature jack.
- 2) Set the Function / Range switch to the "°C" range.
- 3) Connect the K type probe to the object to be measured.
- 4) Read Temperature value in displayed on the LCD.

AUTO POWER-OFF

The function of auto power-off extends the life of the battery by turning the meter off if the range switch has not been operated for about 15 minutes. To turn the meter on again, just rotate the range switch or press the power switch.

BATTERY AND FUSE REPLACEMENT

If "" appears on the LCD, it indicates that the battery should be replaced. To replace battery, open the case, and replace the exhausted battery with the ratings specified: 9V, NEDA 1604 or 6F22, and then close the case.

Fuse rarely needs replacement and is blown as a result of the operator's error. To replace the fuse, open the case, and replace the blown fuse with the ratings specified: F 250mA/250V (600.219) F 2A/250V (600.524) and then close the case.

ACCESSORIES

- Users Manual: 1 copy
- Test leads: 1 pair
- 9V Battery (NEDA 1604 or 6F22): 1 piece
- K type thermocouple (only for 600.219): 1 piece

Lire attentivement ce mode d'emploi avant la mise en service de ce multimètre numérique SkyTronic.

Explication des symboles



AC (courant ou tension alternatifs)



DC (courant ou tension continus)



Attention ! Consultez le mode d'emploi



Attention ! Haute tension



Terre



Fusible



Sigle d'homologation CE

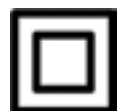

Double isolation

N'effectuez jamais de réparations vous-même et n'apportez jamais de modifications sous peine d'invalider la garantie.

La garantie ne s'applique pas dans le cas de dommages sous quelque forme que ce soit, qui ont été provoqués suite à une mauvaise utilisation et le non-respect des avertissements et consignes de sécurité contenus dans ce manuel.

SkyTronic décline toute responsabilité en cas de dommages corporels suite au non-respect des consignes de sécurité et des avertissements. Ceci s'applique aussi aux préjudices ultérieurs éventuels.