



The EBB Design extractor fans are suitable for many domestic and commercial ventilation applications where higher system resistance pressures are encountered. The EBB Design models incorporate a forward curved centrifugal impeller with single phase motor 230V-50Hz and Class II insulation (□). Maximum operating temperature 40°C.



2 SPEEDS



3 SPEEDS



Back draft shutter

The EBB Design are fitted with an automatic back draft shutter to prevent air entry and limit heat leakage when the extractor is not operating.



Forward curved centrifugal impeller

To deliver high performance with a minimum noise level against high static pressure system resistance.

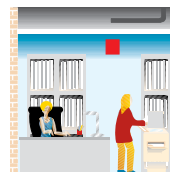

EXAMPLES OF INSTALLATION

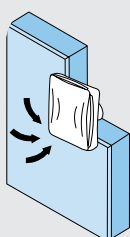

Extract ventilation through the wall or ceiling.

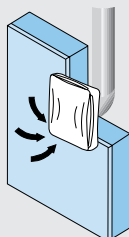

Duct extract ventilation.

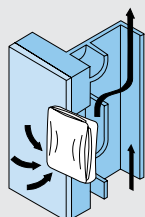

Shunt duct extract ventilation system.

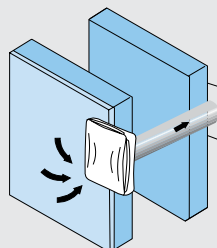

Double wall or telescopic duct extract ventilation.

FEATURES

	EBB-175 DESIGN					EBB-250 DESIGN				
	S	M	T	HM	DV	S	M	T	HM	DV
BALL BEARINGS	●	●	●	●	●	●	●	●	●	●
BACKDRAUGHT SHUTTERS	●	●	●	●	●	●	●	●	●	●
ON/OFF PULL CORD		●		●	●		●		●	●
ONE SPEED MOTOR	●	●	●							
TWO SPEED MOTOR				●	●					
THREE SPEED MOTOR						●	●	●	●	●
ADJUSTABLE RUN-ON-TIMER (1-30 MIN.)			●					●		
INTERNAL HUMIDISTAT (60-90 RH%)				●					●	
2-POSITION INTEGRATED SWITCH								●	●	●

TECHNICAL CHARACTERISTICS

Model type	Speed (rpm)	Maximum power absorbed (W)	Maximum current absorbed (A)	Maximum air volume (m ³ /h)	Sound pressure level (dB(A))	Insulation IP	Weight (kg)
EBB-175 DESIGN	1250	26	0,12	155	41	Class II/ IP44	2,2
	930	17	0,10	80	33		
EBB-250 DESIGN	HS 1960	68	0,29	240	51	Class II/ IP44	2,2
	MS 1580	51	0,22	190	47		
	LS 1280	43	0,2	140	43		

* Sound pressure level measured at 1,5 m at the inlet, in free field conditions.

DIMENSIONS (mm)

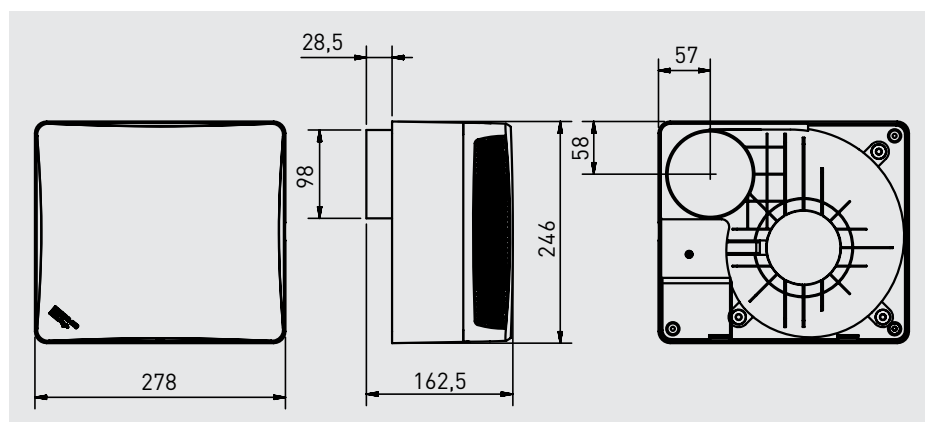

PERFORMANCE CURVE

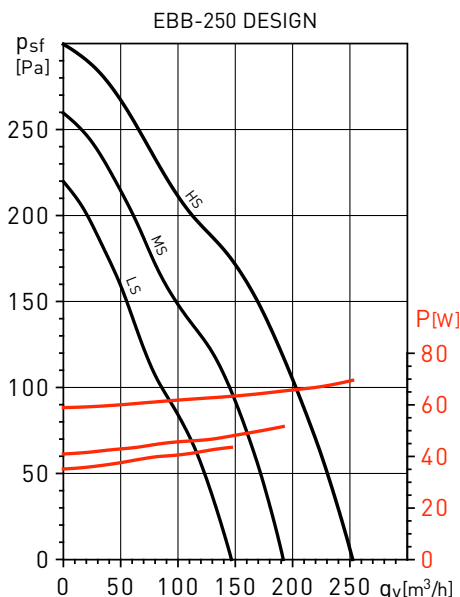
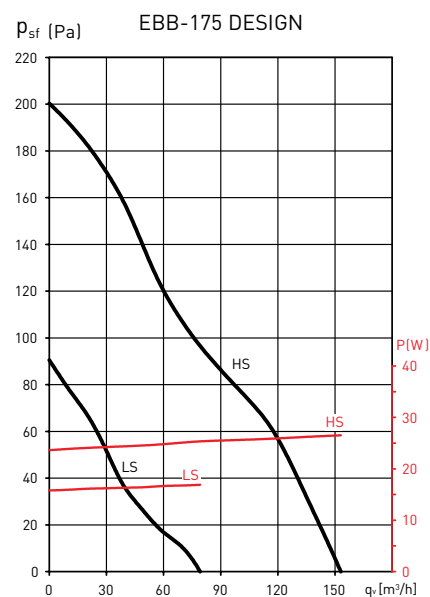

* 2 speed motors only for HM and DV models.

ACCESSORIES



GSA-M0 100
Flexible aluminium ducting.



GRA-75
Aluminium external grille.

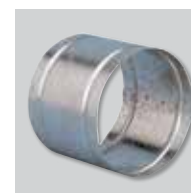

MRT-100
Circular duct joining piece.



CX-80/125
Worm drive ducting clip.



REB
Single phase electronic speed controllers.