

Product selected: CMI-T 70W/NDL UVS

CMI lamps are a new family of compact metal halide lamps incorporating a ceramic discharge arc tube which ensures improved performance, colour uniformity and stable colour throughout lamp life.

Applications

- Indoor lighting: shop wall, floor and window displays, offices, hotel lobbies, etc.
- Outdoor lighting: decorative architectural and accent lighting

Features

- Superior colour rendering
- Colour stability and uniformity
- High luminous efficacy
- UV stop
- Retrofit for quartz equivalent types

Directions for use

- External ignitor only
- Only use in luminaire fitted with a protective cover glass

Product Attributes

Item description	CMI-T 70W/NDL UVS
Ordering Code	0020305
EAN code	5410288203058
Packing Quantity	12
Wattage (W)	72
Voltage (V)	95
Cap	G12
Max. Over. Length (mm)	90
Diameter (mm)	20
Light output (lm)	6000
Current (A)	0.98
Bulb finish	clear
Colour Temp (K)	4200

Product Image



Line Drawing

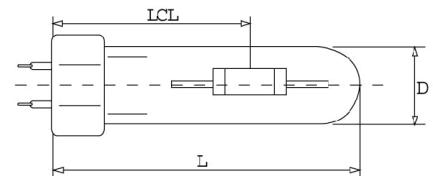

Burning Position

Spectral Diagram

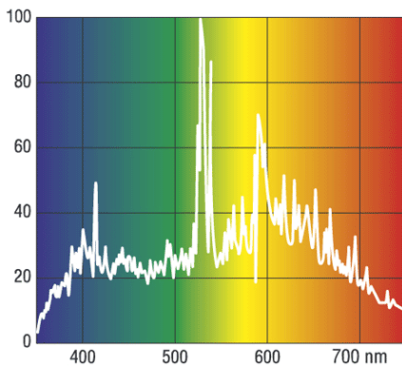

Run-up Characteristics

Ceramic Metal Halide

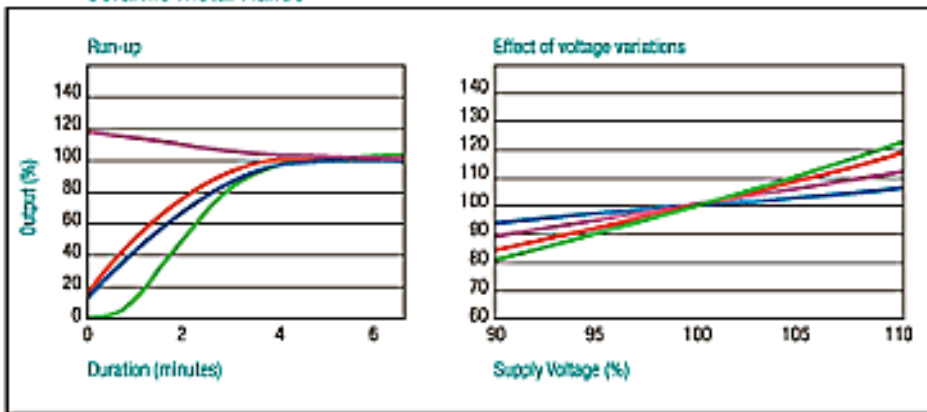

Re-start time when hot
 TD versions: immediate with appropriate start up system
 T, TC versions: up to 10 minutes

■ Lamp Voltage
 ■ Lamp Current
 ■ Lamp Power
 ■ Luminous Flux

Circuit Diagram

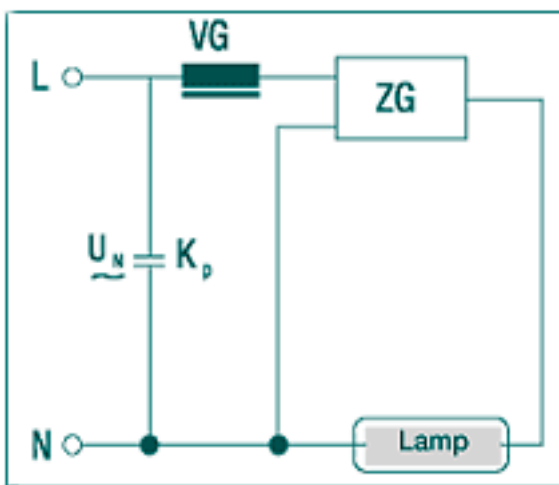

L Live conductor L₁, L₂, L₃
 N Neutral conductor
 U_N power supply voltage 230V~
 (400V~ for HSI-T 2000V)
 VG ballast
 K_p lead capacitor
 ZG start-up system
 K_z start-up capacitor
 ST stray field transformer
 CWA constant wattage autotransformer