

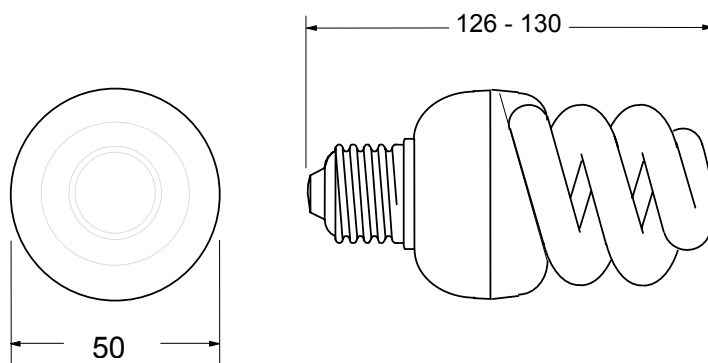

DIMENSIONS (mm)



Cap Type: E27 – IEC-7004-21

ELECTRICAL DATA¹

		<u>Nominal Value</u>	<u>Min.</u>	<u>Max.</u>
Lamp rated wattage	(W) :	20		2.2
Lamp operating voltage	ac 50/60 Hz (rms) (V) :	220-240		
Lamp current	ac 50/60 Hz (rms) (mA) :	150		

OPERATING CONDITIONS:

		<u>Nominal Value</u>	<u>Min.</u>	<u>Max.</u>
Cap Rim Temperature	(°C) :			80
Lamp Ambient Temperature	(°C) :	25	0	40
Starting Time at 25°C	(s) :	2		
Operating Position	:	Unrestricted		
Weight	(g) :	85		

LAMP LIFE²

Average life (IEC Test Cycle) (h) : 6000

<u>PHOTOMETRIC DATA:</u>	colour no.	LuminousFlux ¹ nominal value (lm)	CRI (Class)	Colour Temp. (K)	ILCOS Code	Energy Efficiency Class
	827	950	1b	2700		A

ATTENTION:

Lamps comply with EN 60968 (Safety Requirements), EN 60969 and EN 50285 (Performance Requirements) and CE Regulations.
¹ Measured according to EN 60 969, at 50 Hz, lamp aged 100h.
² Life test according to EN 60 969.

Issued by : SLI SHIPLEY	DATA	Number : 47008
Date : 31.10.2005		Supersedes :
Revision date :		Page : 1 of 1

SLI reserves the right to change data and specifications without notice.
Data for guidance only.