

Twin Spot 8W x2 LED Lighting With Motion Detection Sensor

Model: LED200PIRWH - White

Model: LED200PIRB - Black



1. Designated Use

- LED200PIR is an outdoor motion detector for automatic LED lighting control
- Suitable for installation on walls
- Simple plug in wall plate for easy & safe connection
- Suitable for a wide range of locations: corridors, gardens, staircases, entrances, garages, outdoor parking areas etc.



2. Basic Safety Instruction

Danger of death through electric shock.



- Must only be installed by qualified electricians.
- Avoid the metal parts of the device due to potentially high temperature.
- The device conforms to EN60598 for designated installation; IP44 in accordance with EN 60598 and IEC62471 Photo biological safety of lamps and lamp system.
- Designed for use in normal environments
- Intended for outdoor installation.
- Energy saving.
- Long LED bulb life.

Index :

Page 2	Contents, Tools required.
Page 3	Product dimensions.
Page 4	Installation procedure.
Page 5	Sensor detection range .
Page 6	Walk test & adjustment, Detector head adjustment.
Page 7	Knob settings.
Page 8	Lens masking.
Page 9	Lamp adjustment, High temperature in lamp.

3. Contents:

Whats in the box?

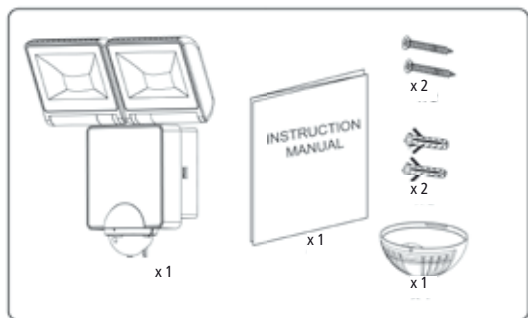

2



4. Tools Required:

Tools/equipment needed for installation.



x1



x1



x1

5. Product Dimensions:

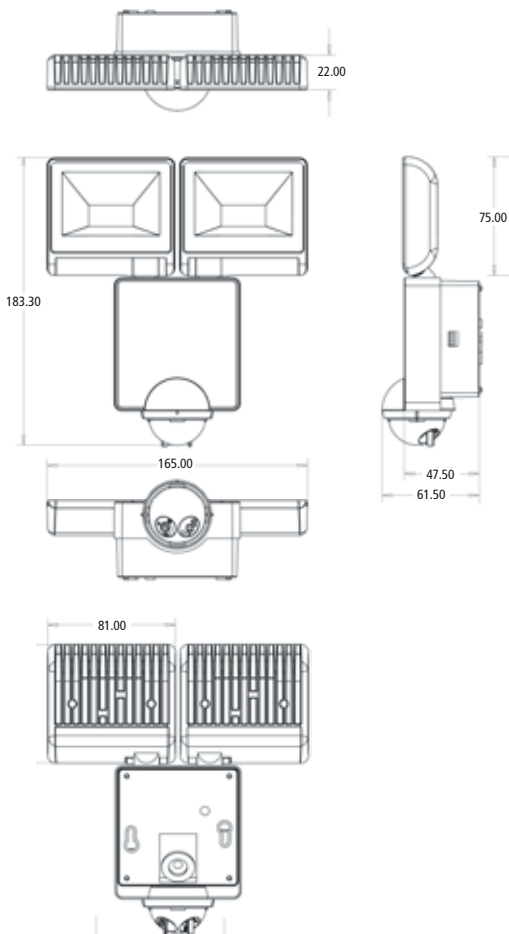

6. Installation Procedure:

Switch off the power.

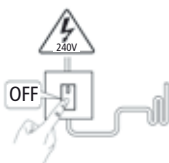

Twist-open the wall plate.



Fix the wall plate to the wall.

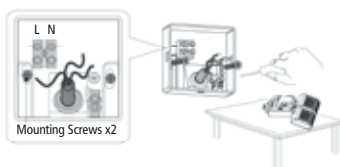
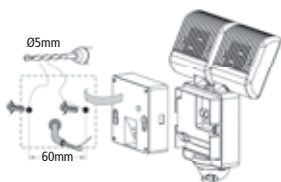

4

Feed the wires through rubber gasket of the wall plate and attach to corresponding terminal.

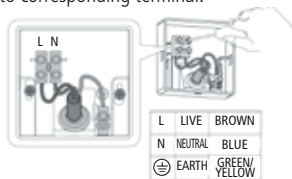

Attach the device to the wall plate.



Switch On the power.

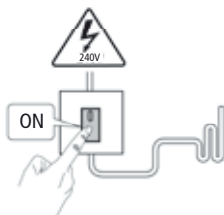

Unit goes into warm-up period for 40 sec.

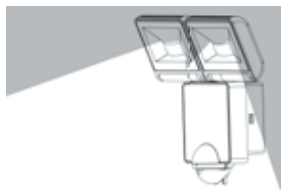

Installation Advise:



As the detector responds to changes in temperature, avoid the following situation:

- Pointing the detector towards objects with highly reflective surfaces, such as mirrors etc.
- Mounting the detector near heat sources, such as heating vents, air conditioning units, lights etc.
- Pointing the detector towards objects that may move in the wind, such as curtains, tall plants etc.

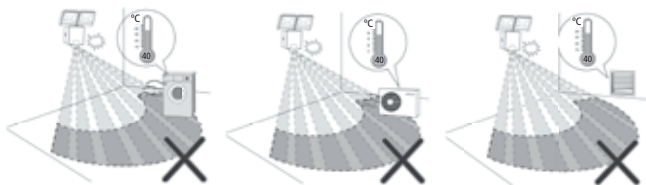

Detection Range:

LED200PIR: Recommended installation height is 2.5 meter above ground, the maximum detection range about 10 meter and at the angle of about 140 deg.

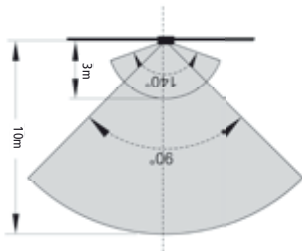
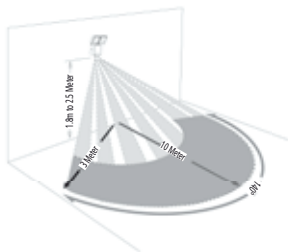

Walk Test and Adjustment

The purpose of Walk Test is used to test and adjust the detection coverage of LED200PIR under auto mode.

- Adjust the Time knob to "T", then conduct a walk test as described in test procedure.

Test procedure:

- Adjust the Time knob to "T", (Lux knob can be "Sun" or "Moon").
- Switch power on.
- Walk across the detection area, once the detector is triggered and the lamp will turn On for 2 seconds.

Note walking direction when performing test.

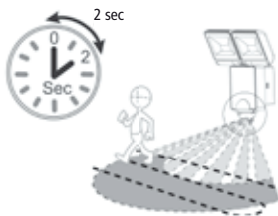
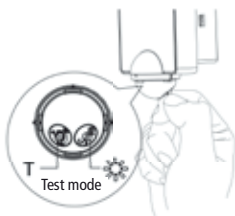

Detector Head Adjustment

The detector head can be panned 90 deg. to the left and 90 deg. to the right.

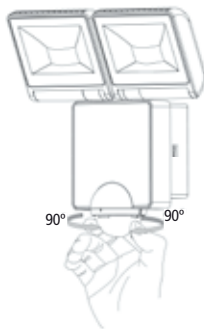

Knob Settings

LED200PIR has two adjustment knobs:
Time and Lux at the bottom of the detector head.

- Adjust knobs carefully with hand.



TIME knob setting

- You can set the time knob from 5 sec to about 10 min, LED200PIR will turn On the lamp, for the time duration set after each detected movement.
- Adjust the knob as desired.

LUX knob setting

- When setting the Lux knob at "MOON", LED200PIR will only operate in the dark.
- When setting the Lux knob at "SUN", LED200PIR will operate in any light level.

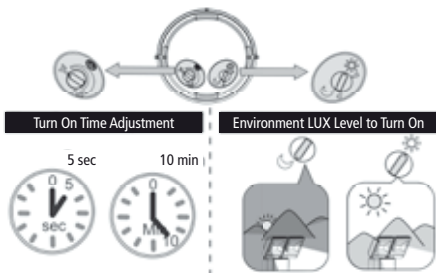

Dusk Setting (Time knob setting)

- When setting the Time knob to "D", the motion detector of LED200PIR won't function. The lamp will operate depending on the "LUX" level, ie Dusk to Dawn..





Lamp turns On at night.



Lamp turns On at day & night.

Setting Advise



Lens masking



The purpose of the lens mask is to mask out areas not desired for detection.

Lens mask fitting procedure:

- Use a penknife or pliers to cut out lens mask segment, exposing area for detection.
- Attach the lens mask to the detector head.
- Turn slightly the lens mask for it to be locked into place.



Lamp Adjustment

The lamp can be tilted down 85 deg. and pan outwardly 40 deg.

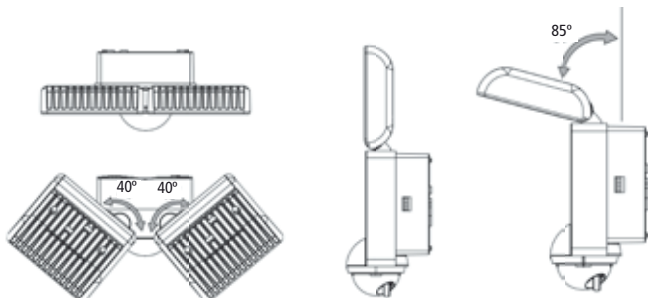

WARNING

9

High Temperature

The temperature of the lamp is very high during operating. You will get hurt, if you touch the heat sink.

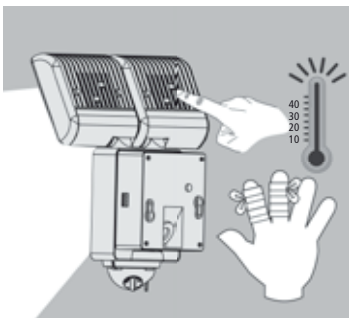
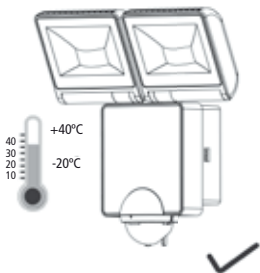

3 Year Guarantee

In the unlikely event of this product becoming faulty due to defective material or manufacture within 3 years of the date of purchase, please return it to your supplier in the first year with proof of purchase and it will be replaced free of charge. For years 2 and 3 or any difficulty in the first year telephone the helpline on 020 8450 0515.



HELPLINE
020 8450 0515

or email helpline@timeguard.com



For a product brochure please contact:

Timeguard Limited.

Victory Park, 400 Edgware Road,
London NW2 6ND

Sales Office: 020 8452 1112
or email csc@timeguard.com

A **theben** Group Company

Designed in the U.K. 67-058-418