

TIMEGUARD®

Wireless 7 Day Programmable Room Thermostat

Model: TRT037N



Installation & Operating Instructions

1. General Information

These instructions should be read carefully and retained for further reference and maintenance.

2. Safety

- Before installation or maintenance, ensure the mains supply to the programmable room thermostat is switched off and the circuit supply fuses are removed or the circuit breaker turned off.
- It is recommended that a qualified electrician is consulted or used for the installation of this programmable room thermostat and install in accordance with the current IEE wiring and Building Regulations.
- Check that the total load on the circuit including when this programmable room thermostat is fitted does not exceed the rating of the circuit cable, fuse or circuit breaker.
- To clean use a clean dry cloth only. Do not use any liquid cleaners

3. Technical Specifications

Receiver

- 230V AC 50 Hz
- This thermostat is of Class II Construction and must not be earthed
- Switch Rating: 3(1)A
- Switch Type: Single pole, voltage free changeover contacts
- Connection Type: 3 wire
- Micro Disconnection: Type 1.B control action
- Illumination: Blue LED illuminated on setting for button surrounds
- Output Light: Red LED
- Installation Type: Surface mount with wall plate
- CE Compliant
- Dimensions (H x W x D): 90 x 95 x 30mm

Transmitter

- Batteries: 2x 1.5V AA
- Operating Temperature Range: 0°C to +40°C
- Set Temperature Range: 10°C to 35°C
- Temperature Swing Adjuster: +/- 0.5°C or 1.0°C set by DIP switch
- Optimum Start Time (OST) Adjustment: ON or OFF set by DIP switch
- Frost Protection Mode: 5°C
- Sleep Mode: Suspends all output, turns off display
- Transmission: 868.3MHz
- Illumination: Blue LED illuminated on setting for button surrounds and display
- Installation Type: Surface mount with wall plate
- CE Compliant
- Dimensions (H x W x D): 90 x 135 x 30mm

Transmitter Front View

Digital room temperature/time display (illuminated on setting)

Light/Frost protection button

+/- setting buttons (illuminated on setting)

10°C to 35°C set temperature range

The heating symbol will show when heat is demanded

Battery compartment located on the side, accessible from rear of transmitter

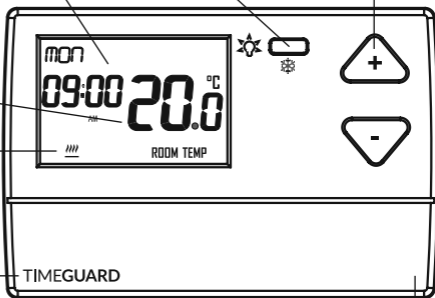

Flip down cover conceals setting buttons

Receiver Front View

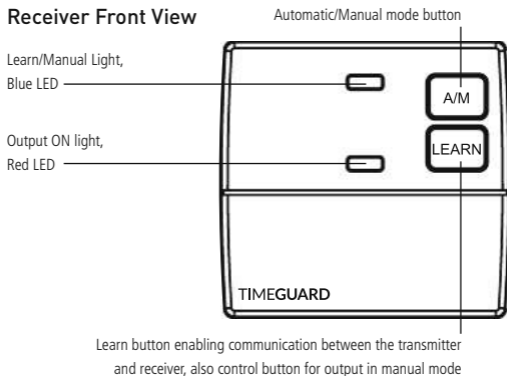

4. Siting

Receiver

- The TRT037N Receiver should be mounted close to the items it will be controlling i.e. boiler, control valves and pump.
- It should be mounted in a position where its control buttons and indicator lights can be easily accessed.

Transmitter

- The TRT037N Transmitter must be sited where it will not be influenced by heat sources, for example above a radiator or a television or a refrigerator/freezer or in direct sunlight or subjected to draughts.
- The product requires air circulation, so do not position above or below shelving or other wall mounted obstacles.
- It should be mounted approximately 1.5 metres above floor level.

5. Installation

Receiver

- 5.1 Ensure the mains supply is switched off and the circuit supply fuses are removed or the circuit breaker turned off.
- 5.2 Remove the wall plate from the receiver unit, by undoing the retaining screws, and pivoting the bottom of the unit outwards. The TRT037N receiver body can then be lifted off.

- 5.3 Mark the position of the mounting holes on the wall using the wall plate as a template. Drill out the mounting holes taking care to avoid any joists, electrical cables or water/gas pipes that may be hidden beneath the surface. Insert the rawl plugs into the holes.
- 5.4 Pass the 230V 50Hz mains supply and load cables through the opening of the wall plate. Allow sufficient excess cable to wire up the unit, but not too much to make it difficult to close the unit to the wall plate.
- 5.5 Fix the wall plate to the wall using the correct mounting screws for the rawl plugs installed. The retaining screws which secure the unit to the wall plate should be at the bottom.
- 5.6 Terminate the cables into the terminal block ensuring correct polarity is observed and that all bare conductors are sleeved (See section 6. Receiver Connection Diagram). Make sure that the curved washer grips the conductor.
- 5.7 To reinstall the unit onto the wall plate, first ensure the wall plate retaining screws are loosened enough to clear the TRT037N receiver body, then engage the top of the TRT037N receiver onto the wall plate retaining tabs, and push firmly downwards and then upwards. There will be some resistance from the terminals.
- 5.8 Once in place, secure with the retaining screws making sure not to over tighten.

Receiver Wall Plate

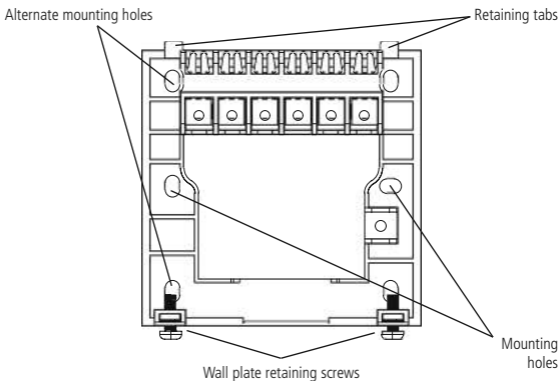

Transmitter

- 5.9 Remove the wall plate from the transmitter unit, by undoing the retaining screws, and pivoting the bottom of the unit outwards. The TRT037N transmitter body can then be lifted off.
- 5.10 Mark the position of the mounting holes on the wall using the wall plate as a template. Drill out the mounting holes taking care to avoid any joists, electrical cables or water/gas pipes that may be hidden beneath the surface. Insert the rawl plugs into the holes.
- 5.11 Fix the wall plate to the wall using the correct mounting screws for the rawl plugs installed. The retaining screws which secure the unit to the wall plate should be at the bottom.
- 5.12 To insert batteries into the unit, access the battery compartment located on the left side/rear of the unit. Use a small flat head screwdriver and release the lug and lever out the battery compartment. Insert the 2 x AA batteries (supplied) maintaining the correct polarity, as shown in the base of the battery compartment. Push the battery compartment back into place until clicks shut.

5

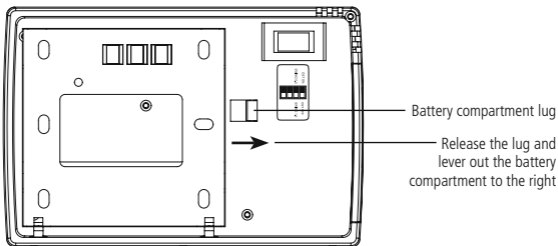

- 5.13 To reinstall the unit onto the wall plate, first ensure the wall plate retaining screws are loosened enough to clear the TRT037N transmitter body, then engage the top of the TRT037N transmitter onto the wall plate retaining tabs, and push firmly downwards and then upwards. There will be some resistance from the terminals.
- 5.14 Once in place, secure with the retaining screws making sure not to over tighten.

Transmitter Wall Plate

Alternate mounting holes

Retaining tabs

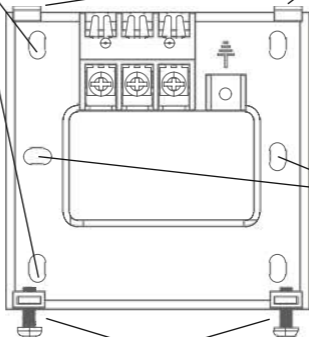

Mounting holes

Wall plate retaining screws

6. Connection Diagram

Connect the 230V 50Hz mains supply and load cables to the terminal block which are marked as follows;

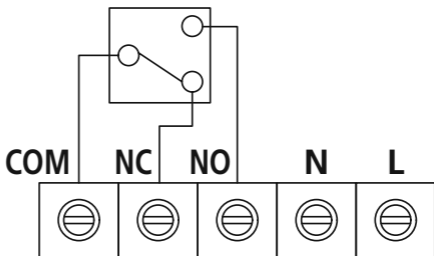

Connections to boiler

Note: Check boiler instructions
before connecting

230V AC 50Hz MAINS SUPPLY

Supply
Neutral

Supply
Live

230V 50Hz Mains Supply

Live Supply (Brown or Red) to

L

Neutral Supply (Blue or Black) to

N

A 'Loop Terminal' is provided should a 3 core cable
be used

Load (Boiler)

Switch Live (Brown or Red) to

NO

7. Transmitter DIP Switch Settings

- The temperature swing can be adjusted between 0.5°C and 1.0°C by selecting the desired DIP switch position found on the rear of the unit. We suggest using 0.5°C position unless the boiler turns ON and OFF too rapidly. A reset will be required after changing the DIP switch positions.
- The OST 'Optimal Start Time' can also be selected ON or OFF using the DIP switches on the rear of the unit. When set to the ON position, the heating will turn on 20 minutes earlier, for every 1°C below your chosen set point. A reset will be required after changing the DIP switch positions.

TRT037N Rear of Transmitter

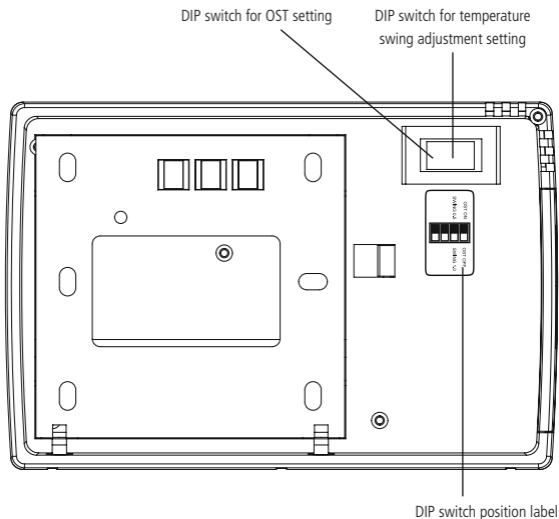

8. Pairing the Devices

- Make sure you have selected the desired DIP switch settings located on the back of the transmitter.
- Press the reset button of on the front of the transmitter, and connect the power to the receiver.

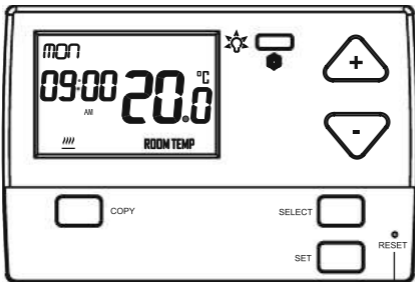

Press the Reset button located beneath the drop down flap

- Both the Learn/Manual light, and the Red output light on the receiver will illuminate for approximately 3 seconds, then go out.

Both the Learn/Manual light, and Red output light will illuminate for approximately 3 seconds, then go out.

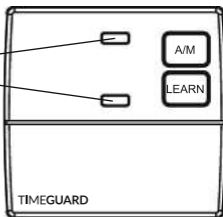

- Press and hold the Learn button on the front of the receiver for 10 seconds until the blue Learn/Manual light starts flashing, the button surrounds will illuminate.

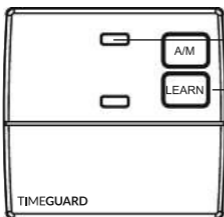

The blue Learn/Manual light will start to flash

Press and hold the Learn button for 10 seconds

- On the transmitter, press and hold the select button for 1 second, and then at the same time press and hold the Light/Frost protection button until the flashing blue Learn/Manual light goes off. This should take approximately 3 seconds.

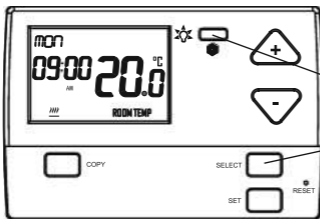

Press and hold the Select button for 1 second, and then at the same time press and hold the Light/Frost protection button, for approximately 3 seconds

The flashing blue Learn/Manual light will turn off

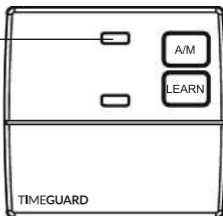

- The transmitter and receiver are now paired.

9. Setting the Time and Date

- To set/alter the time and date at any time, press and hold the Select button for 3 seconds. The display light will illuminate.

SELECT



- The hour will flash, use the Up/Down (+/-) arrow buttons to alter the hour and press the Select button once to confirm.

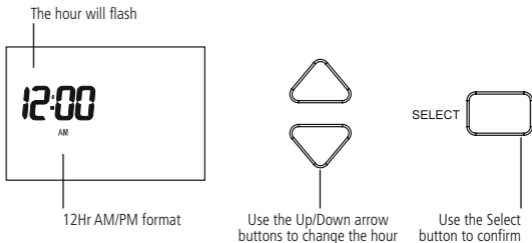

11

- The minutes will flash, use the Up/Down arrow buttons to alter the minutes and press the Select button once to confirm.
- The year will flash, use the Up/Down arrow buttons to alter the year and press the Select button once to confirm.
- The month will flash, use the Up/Down arrow buttons to alter the month and press the Select button once to confirm.
- The day will flash, use the Up/Down arrow buttons to alter the day and press the Select button once to confirm.
- The daylight saving option (GMT=OFF/BST=ON) will flash, by default this will be set to ON. Use the Up/Down arrow buttons to alter the setting if required. Press the Select button once to confirm and return to re-enter the date and time from the beginning, or press the Set button once to confirm and exit.

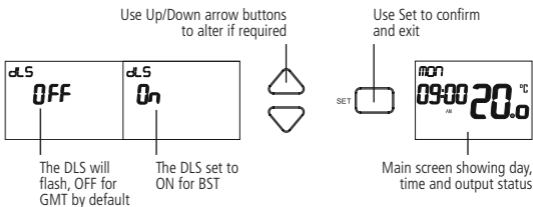

Note:

- If no button is pressed, it will time out after 60 seconds and return to the main screen showing day, time and output status.
- The display light will also time out after 15 seconds after the last button is pressed.
- The Set button can be pressed to exit the date and time entry at any stage.

10. Programming Time/Temperature Periods

Note:

- There are no OFF periods with this controller. As soon as a Start time begins, heat will be demanded until the temperature reaches/falls to the selected set point, then it will move on to the next Start time/temperature period, and so on. The closest you can get to turning the TRT037N programmable thermostat OFF, will be to set the selected period(s) to 10°C, this way the heating will not turn ON unless the temperature drops below these set points.
- If you do not want a higher temperature period in the middle of the day, adjust the temperature for this period downward, to match those of the preceding and subsequent period temperatures.
- There are 6 time/temperature controlled periods, and the default programme for every day is as follows;
 - 06:00AM 21°C
 - 08:00AM 18°C
 - 12:00PM 21°C
 - 02:00PM 18°C
 - 04:00PM 21°C
 - 10:00PM 18°C

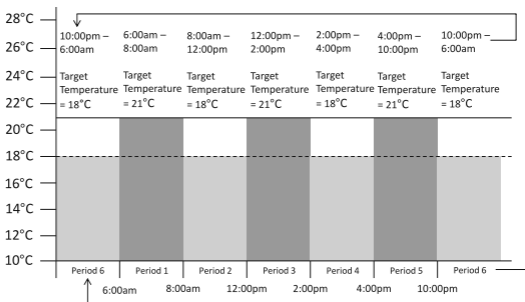

- The Copy function can be used to duplicate Start time/temperature periods, as detailed further in the instructions (read the instructions in full before you begin).

10.1 To programme or modify the time/temperature periods, press and hold the Set button for 3 seconds to enter the programming entry mode. The display light will illuminate

SET



Press and hold the Set button for 3 seconds to enter programming mode.

10.2 The Day of the week will flash (e.g. Mon), use the Up/Down arrow buttons if you need to choose a different day of the week, and then press the Select button once to confirm

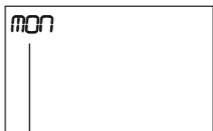

Mon will flash when selected



Use the Up/Down arrow buttons to change the day of the week

SELECT



Use the Select button to confirm

10.3 The Prog 1 (period 1) hour will flash, use the Up/Down arrow button to choose the hour and press the Select button once to confirm.

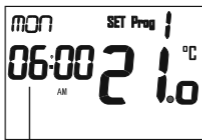

The hour will flash



Use the Up/Down arrow buttons to change the hour

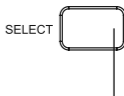

Use the Select button to confirm

- 10.4 The minutes will flash, use the Up/Down arrow button to choose the minutes and press the Select button once to confirm.
- 10.5 The temperature will flash, use the Up/Down arrows to choose the temperature (the temperature increments are in 0.5° steps) and press the Select button once to confirm.
- 10.6 The Prog 2 (period 2) hour will flash. Follow steps '10.3' to '10.5' for Prog 2 (period 2) through to Prog 6 (period 6)
- 10.7 Press the Set button once to change the day of the week (e.g. Tue). Use the Up/Down Arrows to choose the day of the week, and press the Select button once to confirm.
- 10.8 Follow steps '10.3' to '10.7' until you have programmed each day of the week that you require.
- 10.9 Press the Set button three times to exit the programme entry mode.

SET



Note:

- If no button is pressed, it will time out after 60 seconds and return to the main screen showing day, time and output status.
- The display light will also time out after 15 seconds after the last button is pressed
- All 6 Start time/temperature periods will need to be programmed, unwanted Start time/temperature periods need to be entered as the same temperature
- Unwanted days need to be entered as the same temperature (10 °C).
- The Set button can be pressed three times at any stage to exit the programme entry mode.

Copy Function

Note: The copy function can only be used after you have programmed at least one day.

- 10.10 From the main screen, press and hold the Set button for 3 seconds, so the day of the week you have programmed is flashing e.g. Mon (or if you are already in the programming screen, press the Set button once so the day flashes).

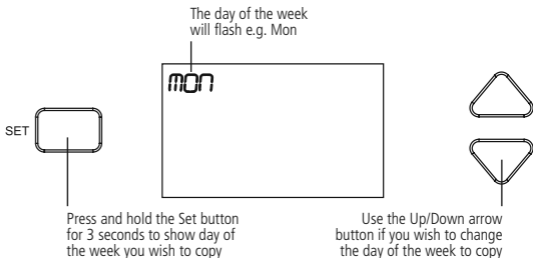

- 10.11 Press the Copy button once to copy the selected day, the word Copy will flash along with the day of the week.



- 10.12 Use the Up/Down arrow button to choose the next day of the week you wish to copy the programme to e.g. Tue, and press the Select button once to confirm.
- 10.13 Use the Up/Down arrow buttons to choose the next day of the week you wish to copy the programme to e.g. Wed, and press the Select button once to confirm.
- 10.14 Repeat step '10.13' until you have copied the programme to all of the days of the week that are required.
- 10.15 Press the Set button three times to exit the programme entry.





Note:

- If no button is pressed, it will time out after 60 seconds and return to the main screen showing day, time and output status.

- The display light will also time out after 15 seconds after the last button is pressed.
- The Set button can be pressed three times to exit the date and time entry at any stage.

11. Programme Modes

Frost Protection Mode

- Press the Light/Frost Protection button and hold for 3 seconds, the button surround and display light will illuminate.  
- The frost symbol will appear and continuously flash on the screen. The set temperature will change to 5°C, and the display will show the actual temperature. The button surround, and display illumination will time out after 5 seconds. 



Frost symbol will continuously flash when frost protection mode is active.

- To disable the frost protection mode, press and hold the Light/Frost Protection button for 3 seconds. The frost symbol will disappear.

Sleep Mode

- Press and hold both the + and – buttons for 3 seconds. Whilst active, all output will be suspended and the display will turn OFF.
- Press any key to exit Sleep Mode.

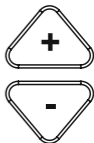

Manual Operation Mode (from the Receiver)

Note: This mode will allow you to manually turn the heating ON/OFF via the receiver.

- Press the A/M button once on the receiver, and the blue Learn/Manual light will illuminate.

The blue Learn/Manual light will illuminate

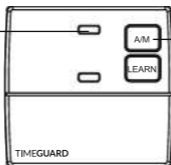

Press the A/M button once

- Press the Learn button to turn the output ON and OFF, the red output light illuminate when calling for heat.

The Red output light will illuminate when calling for heat

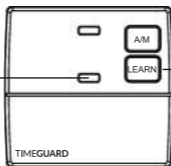

Press the Learn button to turn the output ON and OFF manually

- Press the A/M button once on the receiver to exit, and the blue Learn/Manual light will turn OFF.

Note: There is no temperature control, only ON or OFF operation from the receiver, the transmitter will not do anything whilst in this mode.

Manual Override until Next Programme Change Change (from the Transmitter)

Note: The display shows the current room temperature and correct time.

- Use the Up/Down arrow buttons to change the set temperature, the display light will illuminate and the Hand symbol will appear to show the temperature has been manually changed.

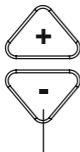

Use the Up/Down arrows to choose the day you wish to copy the programme to e.g. Wed



The new set temperature will flash while the change is being made

The Hand symbol will appear to show the temperature has been manually changed

- The set temperature will flash while the change is being made, and will time out 15 seconds after the last button is pressed. The display will then revert to show the current room temperature.

Heating Symbol

- The Heating symbol will show when heat is demanded.



The Heating symbol will show when heat is demanded.

Back Light

- Pressing the Light/Frost protection once will illuminate the display for 15 seconds.
- Any key press will also illuminate the screen, with a 15 second time out after the last button press.
- Anytime the back light is ON, the Light/Frost protection button surround glows blue.



Battery Low Indicator

- When the transmitter batteries are low, the battery low indicator comes on.



Battery low indicator will appear when the batteries are low.

3 Year Guarantee

In the unlikely event of this product becoming faulty due to defective material or manufacture within 3 years of the date of purchase, please return it to your supplier in the first year with proof of purchase and it will be replaced free of charge. For the second and third years or any difficulty in the first year telephone the helpline on 020 8450 0515.

Note: A proof of purchase is required in all cases. For all eligible replacements (where agreed by Timeguard) the customer is responsible for all shipping/postage charges outside of the UK. All shipping costs are to be paid in advance before a replacement is sent out.

If you experience problems, do not immediately
return the unit to the store.

Telephone the Timeguard Customer Helpline:

HELPLINE

020 8450 0515

or email helpline@timeguard.com

Qualified Customer Support Coordinators will be online
to assist in resolving your query.



A **theben** Group Company

For a product brochure please contact:

Timeguard Limited.

Victory Park, 400 Edgware Road,
London NW2 6ND

Sales Office: 020 8452 1112
or email csc@timeguard.com

www.timeguard.com