

Programa*stat*

7 Day Digital Programmer

Cat. No. TRT034



Operating & Installation Instructions



A **theben** Group Company

What is a programmer?

... an explanation for householders

Programmers allow you to set 'On' and 'Off' time periods. Some models switch the central heating and domestic hot water on and off at the same time, while others allow the domestic hot water and heating to come on and go off at different times.

Set the 'On' and 'Off' time periods to suit your own lifestyle. On some programmers you must also set whether you want the heating and hot water to run continuously, run under the chosen 'On' and 'Off' heating periods, or be permanently off.

The time on the programmer must be correct. Some types have to be adjusted in spring and autumn at the changes between Greenwich Mean Time and British Summer Time.

You may be able to temporarily adjust the heating programme, for example, 'Override', 'Advance' or 'Boost'. These are explained in the manufacturer's instructions.

The heating will not work if the room thermostat has switched the heating off. And, if you have a hot-water cylinder, the water heating will not work if the cylinder thermostat detects that the hot water has reached the correct temperature.



Certification mark

1. Introduction

TRT products are a cost effective comprehensive range of thermostats and timers designed for internal use only.

The TRT034 is a single channel programmer, with automatic summer winter time changeover (which can be cancelled), 5 day plus 2 or 7 (individual) day programming with 3 on and off operations per day, holiday mode, boost function, advance to next program and permanent on/off over ride.

The unit is fitted with a factory installed battery which gives up to 24 hours back up of time, date and programmes in the event of a mains failure.

It is designed to be surface mounted on its supplied wall plate.

The electrical supply **must** be isolated before removing the thermostat from the wall plate.

TRT034 7 Day Digital Programmer (normal position)

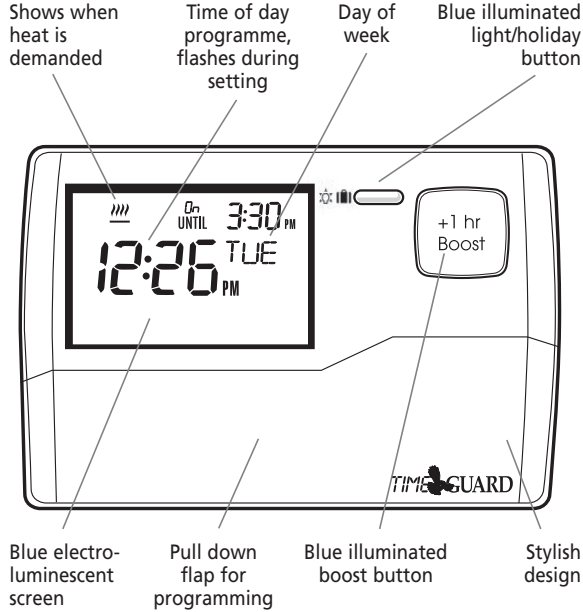

Fig. 1

TRT034 7 Day Digital Programmer (programming cover lowered)

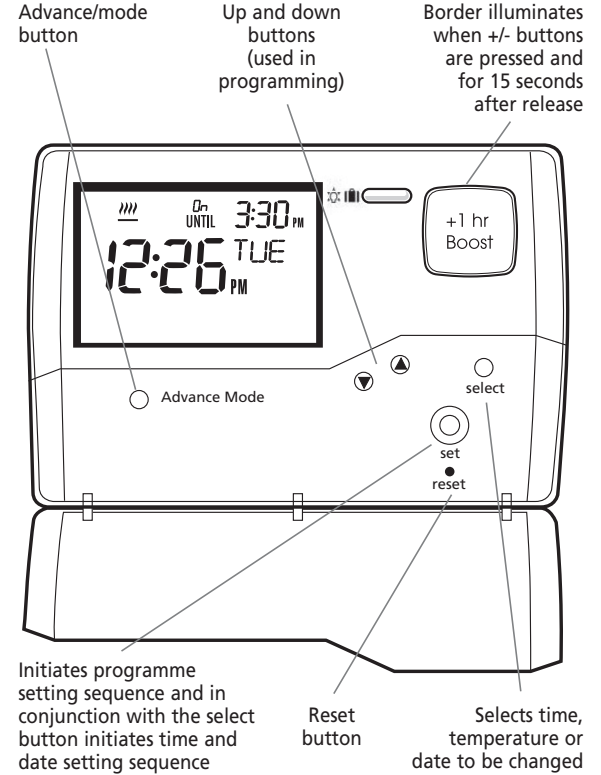
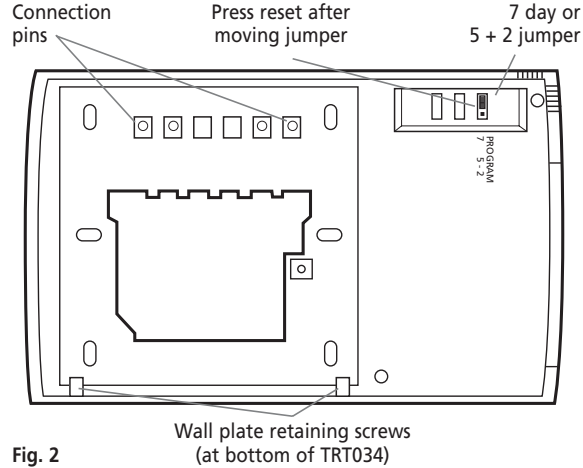
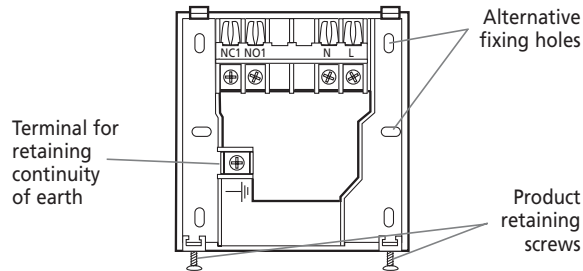

Fig. 1a

Rear View of TRT034



Back Plate Removed



Contents

TRT034 programmer 2 x wall plugs
 TRT034 wall plate 2 x screws
 TRT034 instruction leaflet

2. Siting

The TRT034 should be located at a position which eases wiring runs and gives good access for programming. It should be mounted approximately 1.5m above floor level.

3. Installation

This product must be installed in accordance with the appropriate building and wiring regulations.

In all cases if there is a doubt as to how to proceed with an installation consult a qualified electrician, your local authority's building control department or the Timeguard helpline (020 8450 0515).

Always isolate the mains supply before removing the unit from its wall plate.

The TRT034 is designed to be surface mounted on the supplied wall plate.

Isolate 230VAC mains supply.

Incoming and outgoing cable should be 1.5mmsq.

Remove wall plate from unit, by undoing retaining screws, and pivoting the bottom of the unit outwards. The unit can then be lifted off.

Pass incoming wires through opening in wall plate, and fix wall plate securely to the wall, using screws provided (and wall plugs if necessary). The screws which hold the product to the wall plate should point downwards.

Allow sufficient excess cable to wire up the unit, but not too much to make it difficult to close the unit to the wall plate.

Connect the conductors to the relevant terminal, according to the wiring diagram on the wall plate (or below). Ensure that the curved brass washer grips the conductor.

Wiring Diagram

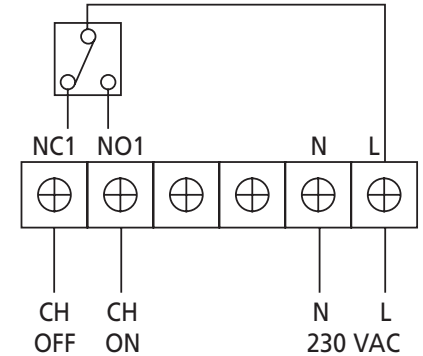

This unit is double insulated, and hence does not need connection to earth. If earth continuity is required, please use earth terminal on wall plate.

To reinstall the unit on the wall plate hook the top of the unit over the retaining tabs, and push firmly back. There will be some resistance from the terminals. Once in place, secure with the retaining screws.

Restore mains to the unit after checking all system wiring is complete.

4. Operation

Decide whether weekday/weekend (5-2) or individual (7) day programming is required, and move the jumper on the rear of the product (see Fig. 2).

It is important to make this decision first, as after any change of jumper position, reset needs to be pressed, which will return the unit to default time and program.

Reset

When programming a new unit or one that has been disconnected from the mains for more than 24 hours, open the program access flap and press the reset button (see Fig. 1a) using a pen or similar implement which will clear the memory.

All of the screen segments will show briefly, and then the default programme will be displayed.

Setting time and date

To programme the current time and date, simultaneously press and hold both the select and set buttons for 3 seconds.

The option 12 hr or 24 hr is displayed and needs to be set. Use the up and down buttons (▼ ▲) to select the required mode. Press select to move to setting the hours. Use the up and down buttons (▼ ▲) to set the hour, and press select to set the minutes. Again use the up and down buttons (▼ ▲) to set the minutes, and then select to set the year (y), the month (m), the day (d), and automatic summer/winter time change or daylight saving (dls) on/off, in each case using the up and down buttons (▼ ▲). Once the time and date have been set, press set to exit back to the operating mode.

If at any time a button is not pressed for 15 seconds, the unit will return to operating mode.

Individual (7 day) programming on/off times

The default on/off times are as follows:

6:00 AM	on
8:00 AM	off
10:00 PM	on
12:00 PM	off
6:00 PM	on
10:00 PM	off

These apply to every day independent of whether weekday/weekend (5-2) or individual (7) day option is chosen.

Note: to omit days and programmes please refer to “Omitting days and programmes”

To change from default values, proceed as follows:-

Press set and MON will flash (with programme (P) 1 on time displayed). Press select and P1 on hour digit(s) will flash, use (▼ ▲) buttons to get the required hours.

Press select and P1 on minute digits will flash, use (▼ ▲) buttons to get the required minutes.



Press select and P1 off hour digits will flash, use (▼ ▲) buttons to get the required hours.

Press select and P1 off minute digits will flash, use (▼ ▲) buttons to get the required minutes.

Press select and programme (P) 2 on hour digit(s) will flash, use (▼ ▲) buttons to get the required hours.

Press select and programme (P) 2 on minute digit(s) will flash, use (▼ ▲) buttons to get the required minutes. This procedure of alternatively using select and (▼ ▲) can be continued to set programmes P2 and P3.

Once complete the second day can be started by pressing the set button when MON will begin to

flash. Press the   buttons to get the required day for programming, then press select and this day can be programmed as Monday above.

Complete all 7 days in the same manner. If set is then pressed twice the TRT034 will return to operating mode.

This defaults to permanently off - refer to “Setting the operating mode” to get into timed mode.

Weekday/weekend (5-2) programming on/off times

For 5-2 day mode, time periods will need to be programmed for M-F (mon-fri) and then for S-S (sat-sun). Only 2 sets of times need to be programmed, not 7.

Setting the operating mode

Once programmed, the default mode is 'continuously off'. To enter programmed mode, press the advance/mode button. One press changes the output to 'continuously on', two presses changes to 'programmed', and three presses changes to 'advance to next program'. In advance mode, once the next time period has past, the programmer returns to programmed mode.

Omitting days and programmes



Days can be omitted by entering the same time in each of the 3 on/off programmes for that day.

In 5-2 day mode the weekend can be omitted by using the same technique for the 2 day (sat & sun) programmes.

A programme (usually P2) can also be omitted for a given day by making the P2 on and off times the same. This can also be applied to P1 and P3 if required.

Boost

In operating mode, there is a boost facility for between 1 and 9 hours in one hour steps. Press the boost button the required number of times for the number of hours of boost required. The programmer returns to operating mode 15 seconds after the last button push. To cancel boost, press the boost button until 0 hrs is shown.

Press and hold the light  button and the programmer will enter **holiday mode**. Use the   buttons to set the required number of days. The programmer will return to operating mode 15 seconds after the last button push. To exit holiday mode, press and hold the light button again.

Screen illumination

Press the light button  briefly at anytime, and the screen will illuminate for 15 seconds.

To clean use a clean dry cloth only. Do not use any liquid cleaners.

5. Specifications

Current rating: 3 (1) A

Voltage: 230V, 50Hz

Switch type: Single pole, double throw (SPDT)

Operating temperature range: 0°C to 50°C

Complies with: BS EN 60730

Conforms to directives: 73-23-EEC, 89-336-EEC

Micro disconnection: Type 1.B control action

For assistance with the product please contact:-

HELPLINE

020-8450-0515

or email helpline@timeguard.com



3 Year Guarantee

In the unlikely event of this product becoming faulty due to defective material or manufacture within 3 years of the date of purchase, please return it to your supplier in the first year with proof of purchase and it will be replaced free of charge. For years 2 and 3 or any difficulty in the first year telephone the helpline on **020 8450 0515**.

For a product brochure please contact:

Timeguard Ltd. Victory Park, 400 Edgware Road,

London NW2 6ND Tel: 020-8452-1112

or email csc@timeguard.com

A **thobon** Group company

67-058-325