

# LEON

## Riser rail assembly

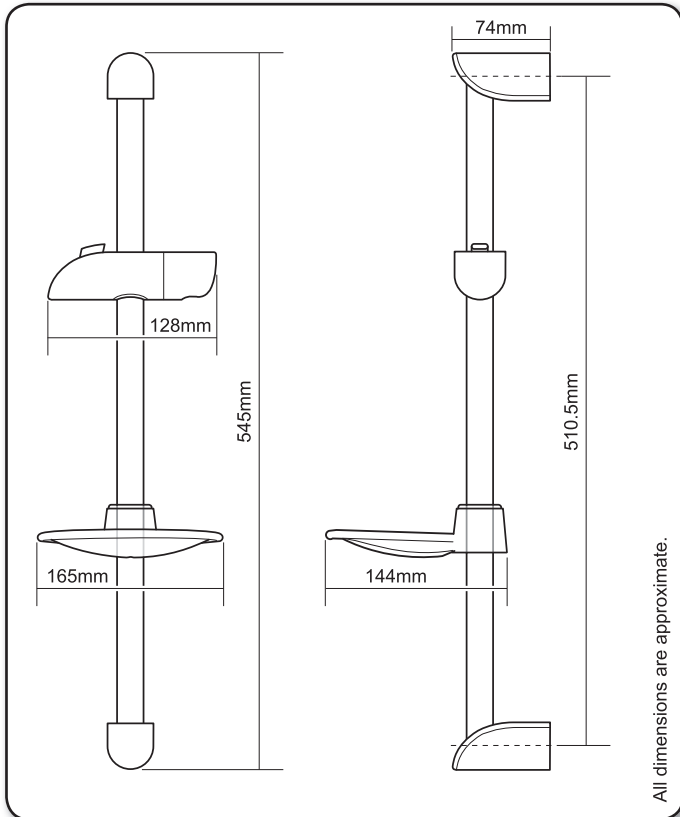

# Installation Instructions

INSTALLERS PLEASE NOTE THESE INSTRUCTIONS ARE TO BE LEFT WITH THE USER

## FITTING THE RISER RAIL ASSEMBLY

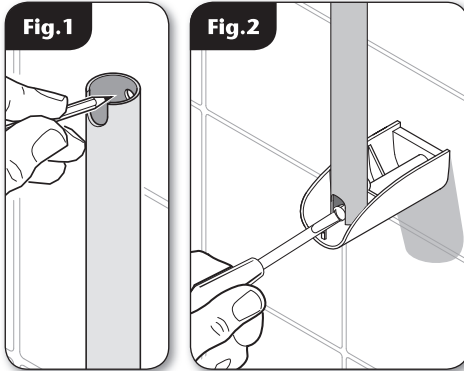

### FITTING THE RISER RAIL

#### WARNING!

**Check there are no hidden cables or pipes before drilling holes for wall plugs. Use great care when using power tools near water. The use of a residual current device (RCD) is recommended.**

Decide the position for the rail on the wall within the shower area. Proceed as follows:

- Offer one of the brackets to the wall for the lower position (both brackets are the same) and mark the centre fixing hole position.
- Drill and plug the wall. (*An appropriate drill bit should be used. If the wall is brick, plasterboard or a soft building block, appropriate wall plugs and screws should be fitted.*)
- Using the riser rail as a guide, line up the bottom hole with the wall plug just fitted. Making sure the rail is positioned straight, mark the top fixing hole (**fig.1**).
- Drill and plug the wall as described above.
- Offer the bottom bracket and riser rail to the wall and secure, but **DO NOT** fully tighten yet (**fig.2**).

**Note:** *The large cut out section on the riser rail should be at the front when fitting it.*

- Before the top bracket can be secured into place, the following items need to be fitted onto the riser rail in the order and orientation shown in (**fig.3**) - the slider/holder can be fitted with the showerhead on either the left or right of the riser rail.
- Once all items are in place the top bracket should be secured to the wall and bottom bracket fully tightened.
- Finally the top and bottom trims can be clicked into place.

*Should the need arise, the trim cover can be removed by inserting a screwdriver and very carefully levering it away from the bracket.*

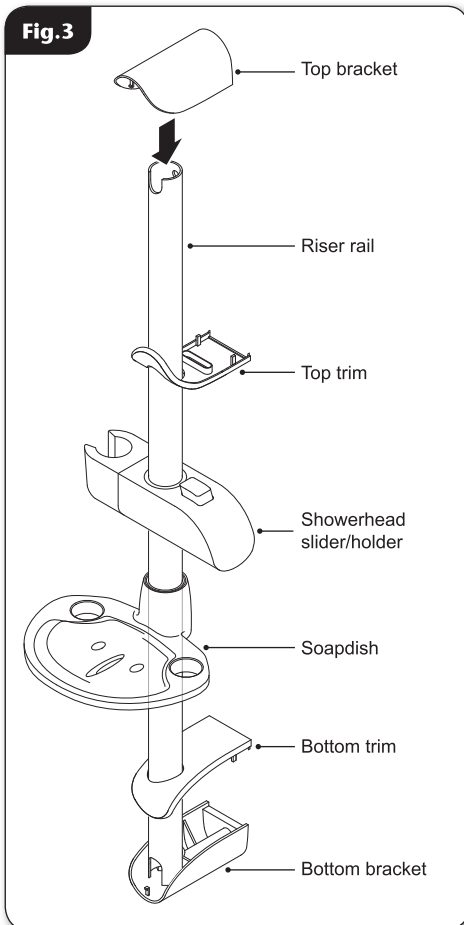

## FITTING THE RISER RAIL ASSEMBLY

### FITTING THE HOSE AND SHOWERHEAD

- Feed the flexible hose through the appropriate soap dish opening (**fig.4**) so that the dish acts as a retaining ring (Water Regulations).

**Note:** *The holder is slightly tapered and the showerhead and hose will only fit from one direction.*

- Screw the flexible hose onto the shower outlet and showerhead (**fig.5**), making sure the supplied washers are in place at both ends of the flexible hose.
- Place the showerhead into the holder (**fig.6**) and check that it fits correctly.

**IMPORTANT:** *This riser rail assembly is supplied with a hose retainer. Water Regulations require the fitting of a double check valve or similar device in the supply pipework to prevent backflow if the retainer is not used.*

**IMPORTANT:** *It is the conical end of the hose which grips into the holder. The showerhead will not fit in the holder without the hose attached.*

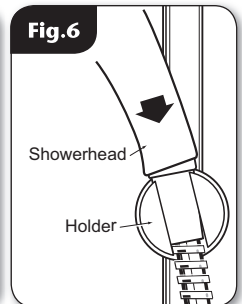
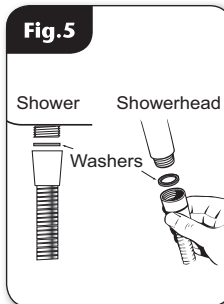
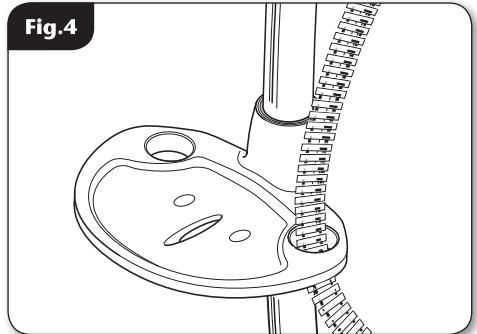

## SPARE PARTS

<b>Ref. Description</b>	<b>Part Number</b>
-------------------------	--------------------

- |                             |          |
|-----------------------------|----------|
| - Kit without rail          |          |
| <i>white</i> .....          | 88900031 |
| <i>chrome</i> .....         | 88900032 |
| <b>1. Brackets (pair)</b>   |          |
| <i>white</i> .....          | 83314430 |
| <i>chrome</i> .....         | 83314440 |
| <b>2. Trim (single)</b>     |          |
| <i>white</i> .....          | 83314450 |
| <i>chrome</i> .....         | 83314480 |
| <b>3. Riser rail 530mm</b>  |          |
| <i>anodised</i> .....       | 88800021 |
| <i>chrome</i> .....         | 88800022 |
| <b>4. Showerhead holder</b> |          |
| <i>white</i> .....          | 83314470 |
| <i>chrome</i> .....         | 83314480 |
| <b>5. Soap dish</b>         |          |
| <i>clear</i> .....          | 22011850 |

Flexible hoses available in the following sizes:

- 1.00m in white, chrome and gold
- 1.25m in white, chrome and gold
- 1.75m in chrome only

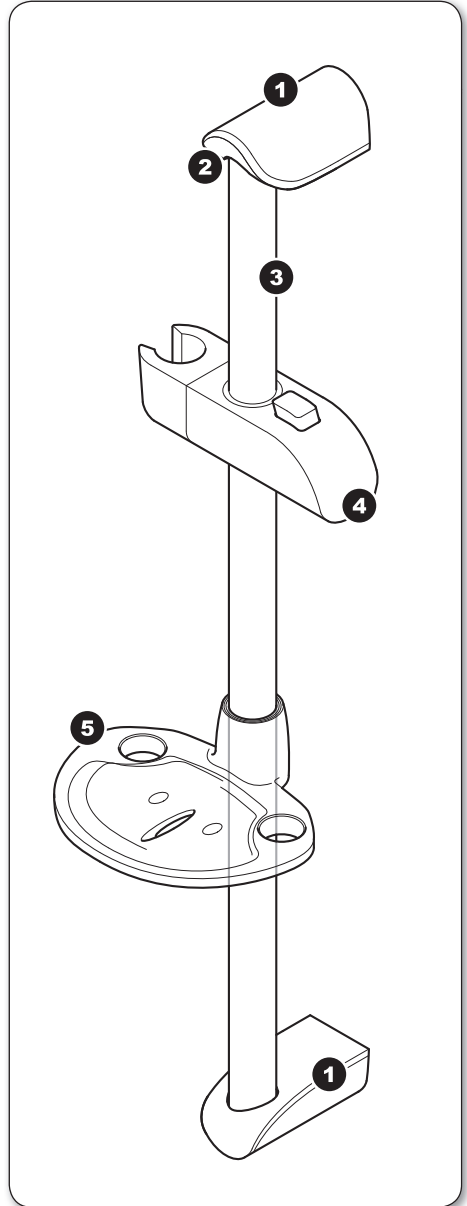

**Please refer to shower installation and operating instructions for service details**