

NENE

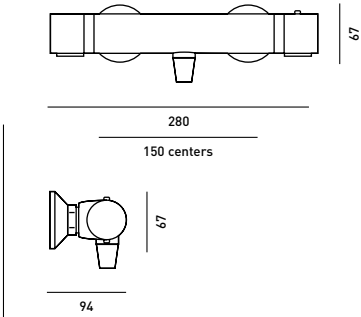

UNNETHBM
Bar mixer

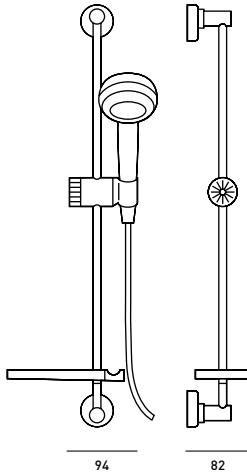

Mixer valve type	Thermostatic
Operation	Dual control
Pressure range	0.2 bar - 5 bar
Maximum static pressure	10 bar
Minimum flow required to both inlets	8 litres per minute
Plumbing system	All, nominally equal pressures
Connections: Inlet	1/2" BSP
Connections: Outlet	1/2" BSP bottom
Water supplies	Rising, falling or rear entry
Inlet fittings supplied	Straight (see page 27)



UNNETP1-2
Basin taps

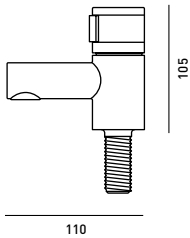

UNNETP3-4
Bath taps

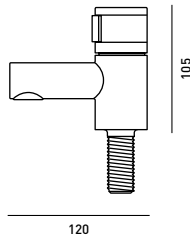

ANE004CP
Glass soap dish & holder

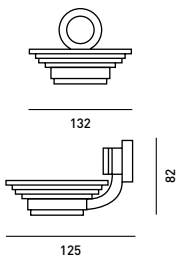

AWE015CP
Liquid soap dispenser

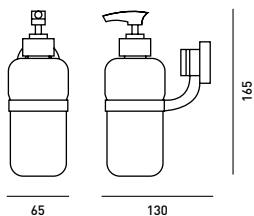

ANE014CP
Wire soap basket

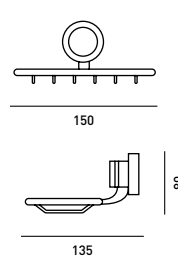

ANE009CP
Robe hook

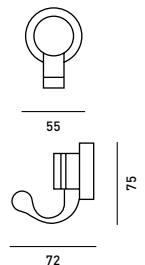

NENE



ANE186CP
Small Towel rail

ANE006CP
Large Towel rail

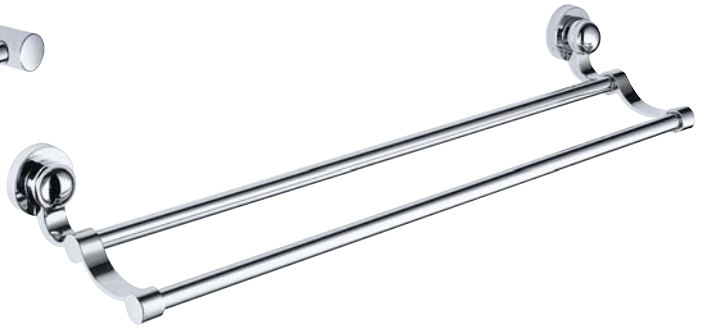
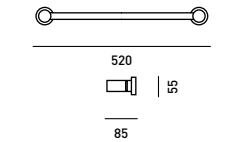

ANE246CP
Double towel rail

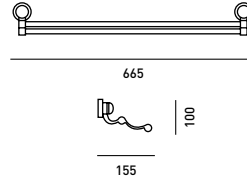

ANE003CP
Glass shelf

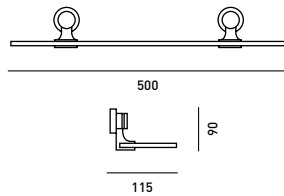

ANE005CP
Frosted glass
tumbler & holder

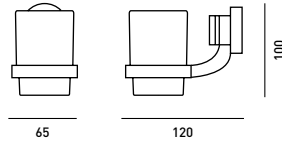

ANE010CP
Glass toilet brush
& holder

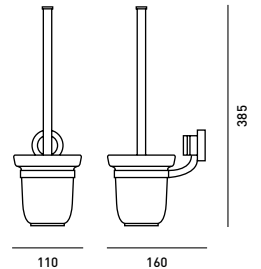

ANE013CP
18" Mirror swivel
& brackets

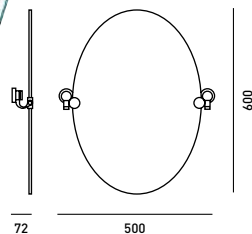

ANE001CP
Toilet roll holder

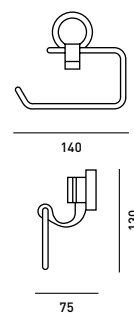

ANE002CP
Towel ring

