

THAMES

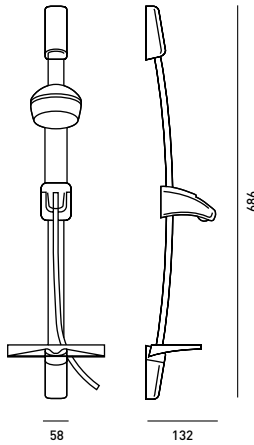

UNTHEXCM
Exposed



58

132

686

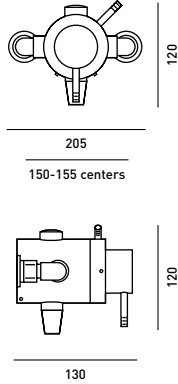

205

150-155 centers

130

120

120

Mixer valve type	Thermostatic
Operation	Dual control
Pressure range	0.1 bar - 5 bar
Maximum static pressure	10 bar
Minimum flow required to both inlets	8 litres per minute
Plumbing system	All, nominally equal pressures
Connections: Inlet	1/2" BSP
Connections: Outlet	1/2" BSP top or bottom
Water supplies	Rising, falling or rear entry via swivel inlet elbows



UNTHBTCM
Built-in

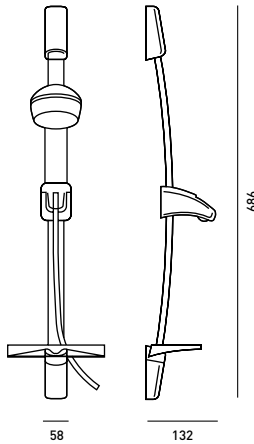

58

132

686

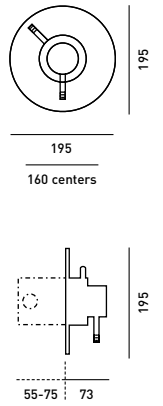

195

160 centers

55-75 73

195

195

Mixer valve type	Thermostatic
Operation	Dual control
Pressure range	0.1 bar - 5 bar
Maximum static pressure	10 bar
Minimum flow required to both inlets	8 litres per minute
Plumbing system	All, nominally equal pressures
Connections: Inlet	Flat face union fittings
Connections: Outlet	1/2" BSP top or bottom
Water supplies	Rising, falling or rear entry
Building in-depth	55-75mm



UNTHDCMX
Dual control

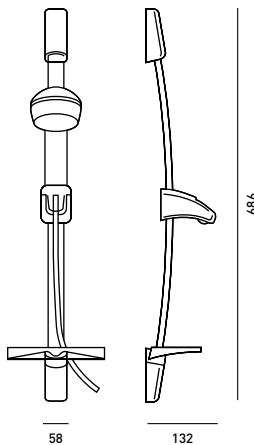

58

132

686

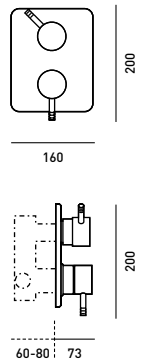

160

60-80 73

200

200

Mixer valve type	Thermostatic
Operation	Dual control
Pressure range	0.1 bar - 5 bar
Maximum static pressure	10 bar
Minimum flow required to both inlets	8 litres per minute
Plumbing system	All, nominally equal pressures
Connections: Inlet	3/4" BSP
Connections: Outlet	3/4" BSP top
Water supplies	Rising, falling or rear entry
Building in-depth	60-80mm

THAMES



Only suitable for high pressure systems

UNTHTPBAM
Basin mixer with pop-up waste

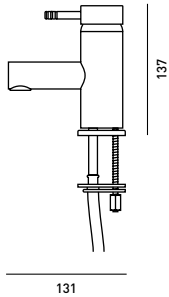

UNTHTP1-2
Basin taps

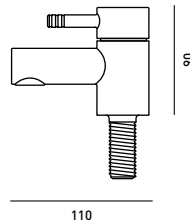

UNTHTP3-4
Bath taps

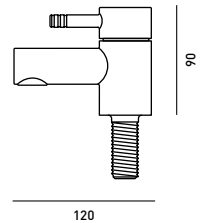

ATH005CP
Frosted glass tumbler & holder

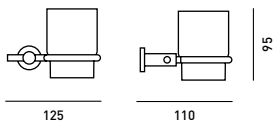

ATH010CP
Glass toilet brush & holder

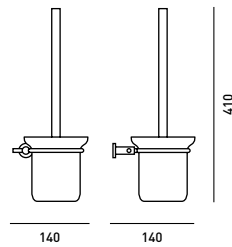

ATH246CP
Single towel rail

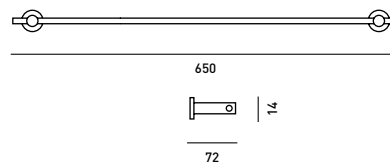

ATH003CP
Glass shelf

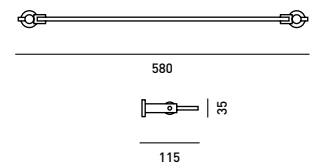

ATH013CP
18" Swivel mirror & brackets

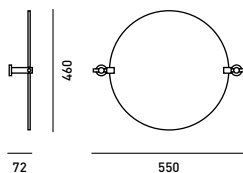

ATH012CP
Robe hook

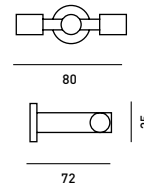

ATH004CP
Glass soap dish & holder

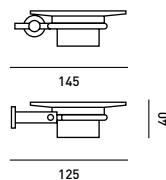

ATH001CP
Toilet roll holder

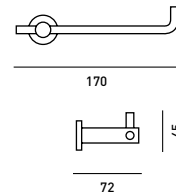

ATH002CP
Towel ring

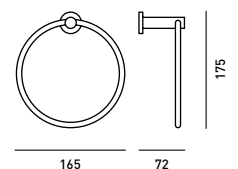

AIRE



**UNAITHBM
Bar mixer**

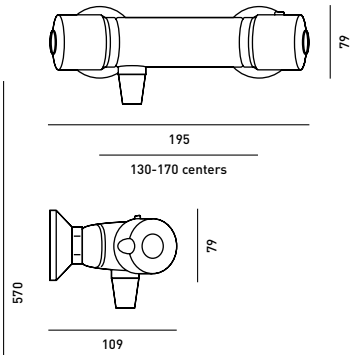
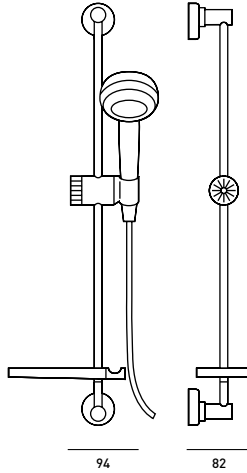

Mixer valve type	Thermostatic
Operation	Dual control
Pressure range	0.2 bar - 5 bar
Maximum static pressure	10 bar
Minimum flow required to both inlets	8 litres per minute
Plumbing system	All, nominally equal pressures
Connections: Inlet	1/2" BSP
Connections: Outlet	1/2" BSP bottom
Water supplies	Rising, falling or rear entry
Inlet fittings supplied	Dog leg (see page 27)



**UNAITHBSM
Bath shower mixer**

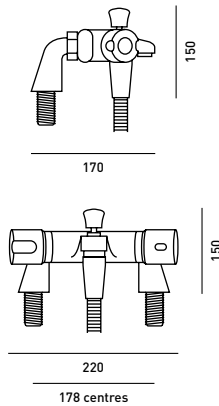

Mixer valve type	Thermostatic
Operation	Dual control
Pressure range	1 bar - 5 bar
Maximum static pressure	10 bar
Minimum flow required to both inlets	8 litres per minute
Plumbing system	High water pressure only, nominally equal pressures
Connections: Inlet	3/4" BSP
Connections: Outlet	1/2" BSP bottom
Water supplies	Rising only

**UNAITPBAM
Basin mixer with pop-up waste**

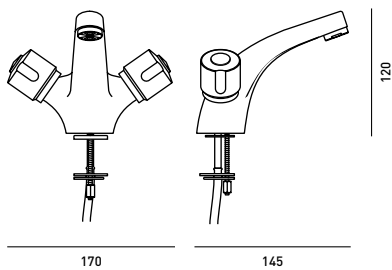

**UNAITP1-2
Basin taps**

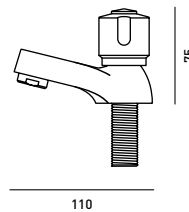

**UNAITP3-4
Bath taps**

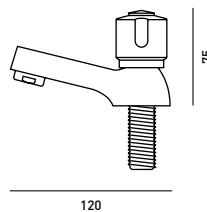

**UNAITPBF
Bath filler**

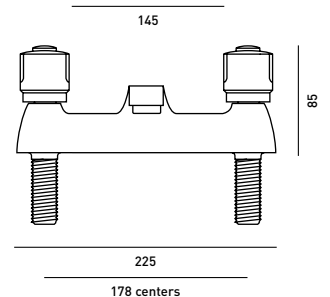
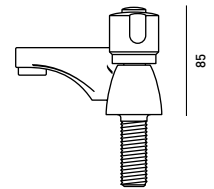

EXE



UNEXPCBM
Bar mixer

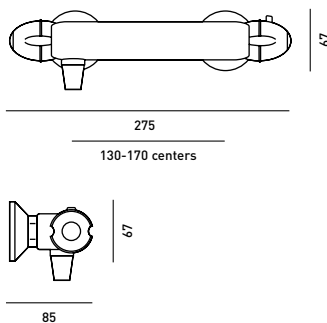
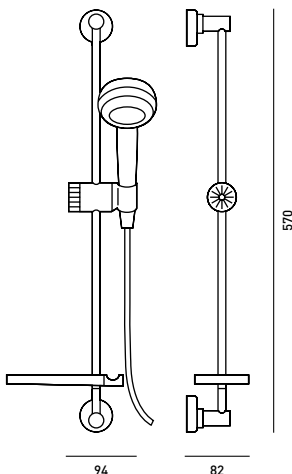

Mixer valve type	Pressure compensating
Operation	Dual control
Pressure range	0.5 bar - 5 bar
Maximum static pressure	10 bar
Minimum flow required to both inlets	8 litres per minute
Plumbing system	High water pressure only, nominally equal pressures
Connections: Inlet	1/2" BSP
Connections: Outlet	1/2" BSP bottom
Water supplies	Rising, falling or rear entry
Inlet fittings supplied	Dog leg (see page 27)



UNEXPCBSM
Bath shower mixer

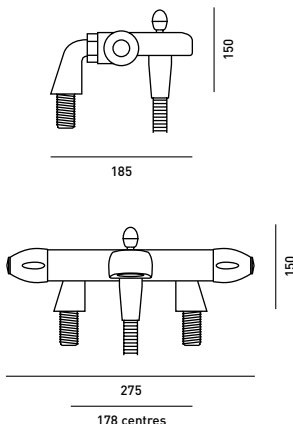

Mixer valve type	Pressure compensating
Operation	Dual control
Pressure range	1 bar - 5 bar
Maximum static pressure	10 bar
Minimum flow required to both inlets	8 litres per minute
Plumbing system	High water pressure only, nominally equal pressures
Connections: Inlet	3/4" BSP
Connections: Outlet	1/2" BSP bottom
Water supplies	Rising only

UNEXTPBAM
Basin mixer with pop-up waste



UNEXTP1-2
Basin taps

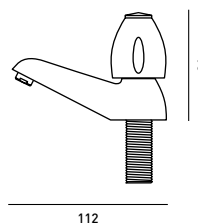

UNEXTPBF
Bath filler

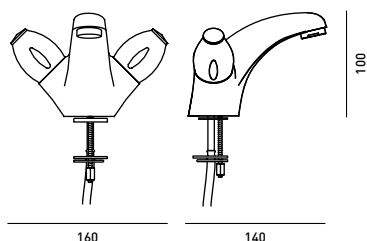
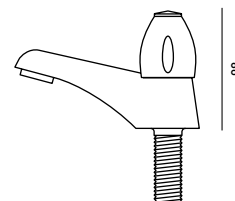

UNEXTP3-4
Bath taps

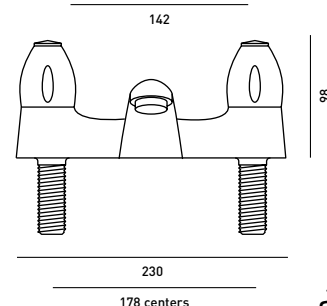
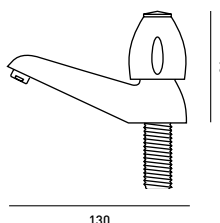

NENE



UNNETHBM
Bar mixer

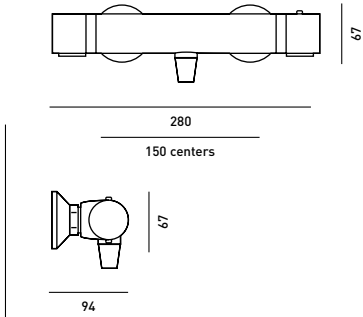
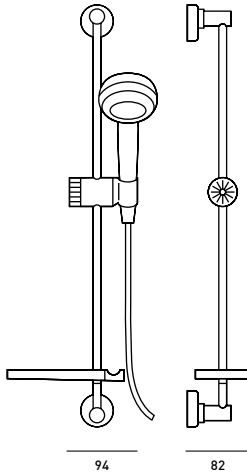

Mixer valve type	Thermostatic
Operation	Dual control
Pressure range	0.2 bar - 5 bar
Maximum static pressure	10 bar
Minimum flow required to both inlets	8 litres per minute
Plumbing system	All, nominally equal pressures
Connections: Inlet	1/2" BSP
Connections: Outlet	1/2" BSP bottom
Water supplies	Rising, falling or rear entry
Inlet fittings supplied	Straight (see page 27)



UNNETP1-2
Basin taps

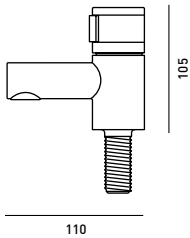

UNNETP3-4
Bath taps

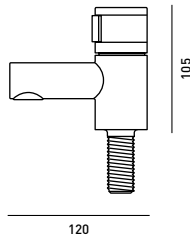

ANE004CP
Glass soap dish & holder

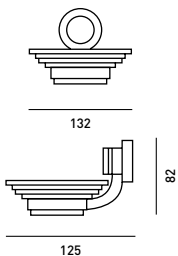

AWE015CP
Liquid soap dispenser

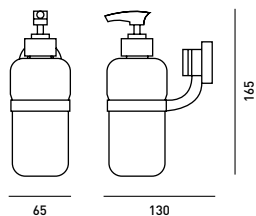

ANE014CP
Wire soap basket

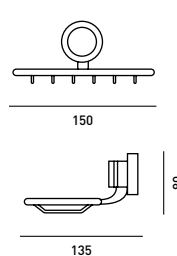

ANE009CP
Robe hook

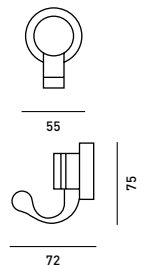

NENE



ANE186CP
Small Towel rail

ANE006CP
Large Towel rail

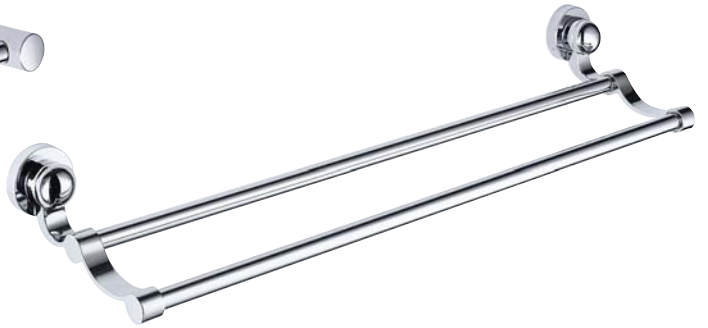
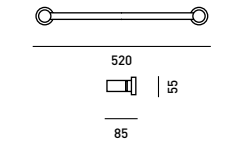

ANE246CP
Double towel rail

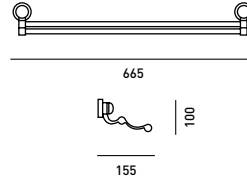

ANE003CP
Glass shelf

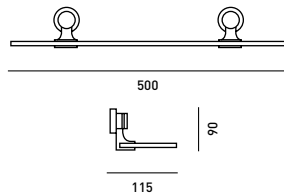

ANE005CP
Frosted glass
tumbler & holder

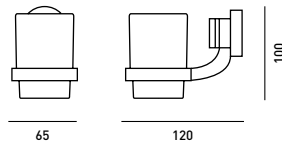

ANE010CP
Glass toilet brush
& holder

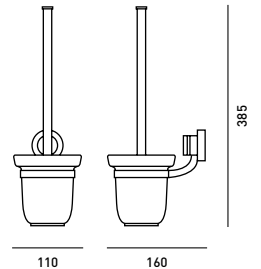

ANE013CP
18" Mirror swivel
& brackets

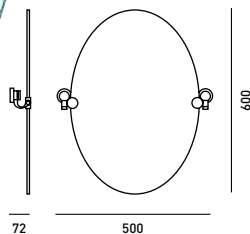

ANE001CP
Toilet roll holder

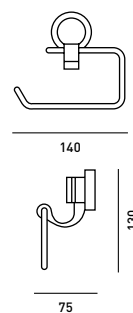

ANE002CP
Towel ring

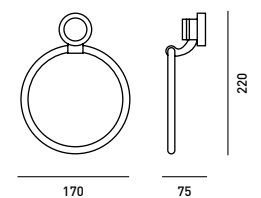

E D E N



UNEDMBSM
Bath shower mixer

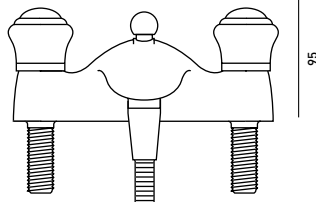

230
178 centres

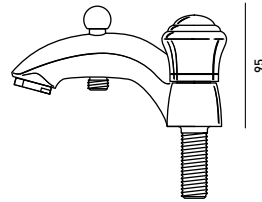

170

Mixer valve type	Manual
Operation	Dual control
Pressure range	0.1 bar - 5 bar
Maximum static pressure	10 bar
Minimum flow required to both inlets	8 litres per minute
Plumbing system	All, nominally equal pressures
Connections: Inlet	3/4" BSP
Connections: Outlet	1/2" BSP
Water supplies	Rising



UNEDTPBAM
Basin mixer with pop-up waste



UNEDBSTP
Basin taps

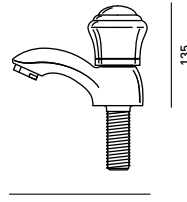

115

UNEDTPBF
Bath filler

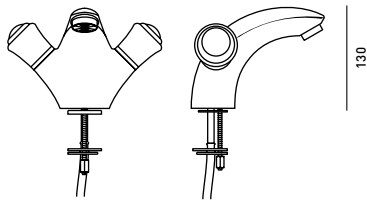

180

160

UNEDBTTP
Bath taps

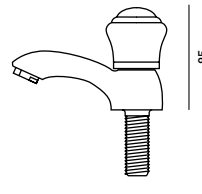

110

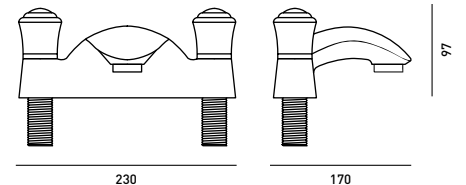

230
178 centres

170

97



AED186CP
Small Towel rail

AED246CP
Large Towel rail

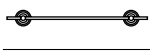

380



50

90



685



50

80

AED003CP
Glass shelf



600



50

120

AED002CP
Towel ring

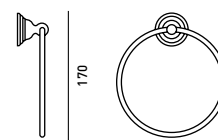

170

45

155

AED005CP
Frosted glass tumbler & holder

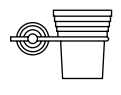

150



95

110

EDEN



AED013CP
18" Swivel mirror

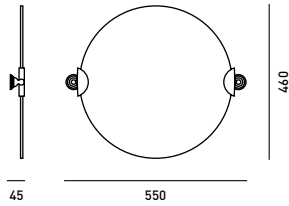

AEDH10CP
Wall mounted toilet brush & holder

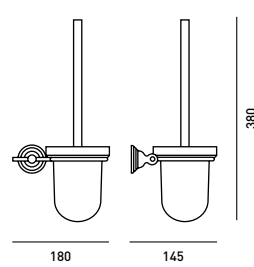

AED010CP
Toilet brush & holder

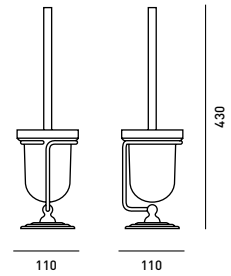

AED001CP
Toilet roll holder

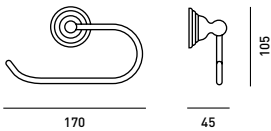

AED014CP
Wire soap basket

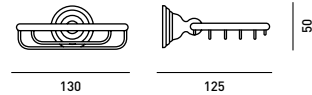

AED004CP
Glass soap dish & holder

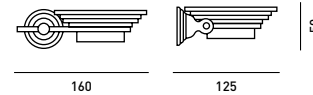

AED009CP
Robe hook

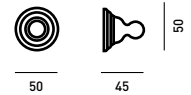

AVON

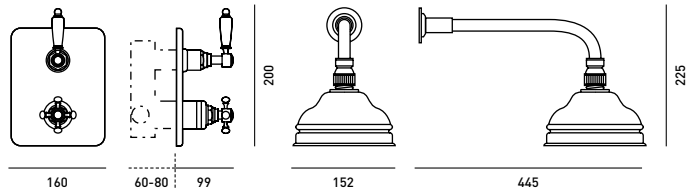

UNAVBACH
Dual control - chrome

UNAVBAGD
Dual control - gold

Mixer valve type	Thermostatic
Operation	Dual control
Pressure range	0.1 bar - 5 bar
Maximum static pressure	10 bar
Minimum flow required to both inlets	8 litres per minute
Plumbing system	All, nominally equal pressures
Connections: Inlet	3/4" BSP
Connections: Outlet	3/4" BSP top
Water supplies	Rising, falling or rear entry
Building in-depth	60 - 80mm

TYNE



UNTYTHBM
Bar mixer

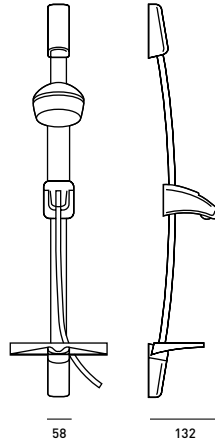

58 132

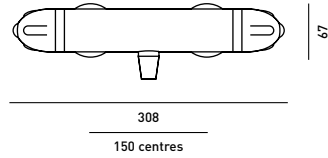

308
150 centres

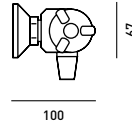

100

Mixer valve type	Thermostatic
Operation	Dual control
Pressure range	0.1 bar - 5 bar
Maximum static pressure	10 bar
Minimum flow required to both inlets	8 litres per minute
Plumbing system	All, nominally equal pressures
Connections: Inlet	1/2" BSP
Connections: Outlet	1/2" BSP bottom
Water supplies	Rising, falling or rear entry
Inlet fittings supplied	Straight (see page 27)



UNTYTHBSM
Bath shower mixer

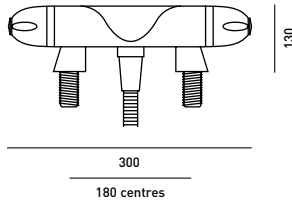

300
180 centres

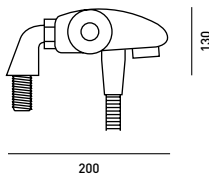

200

Mixer valve type	Thermostatic
Operation	Dual control
Pressure range	1 bar - 5 bar
Maximum static pressure	10 bar
Minimum flow required to both inlets	8 litres per minute
Plumbing system	High water pressure only, nominally equal pressure
Connections: Inlet	3/4" BSP
Connections: Outlet	1/2" BSP bottom
Water supplies	Rising only



UNTYTPBAM
Basin mixer with pop-up waste

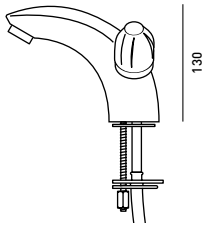

160

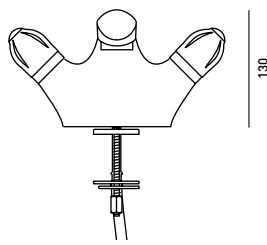

191



UNTYTP1-2
Basin taps

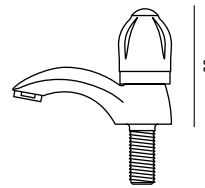

115



UNTYTP3-4
Bath taps

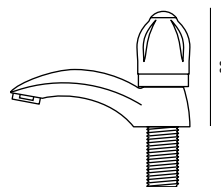

130



UNTYTPBF
Bath filler

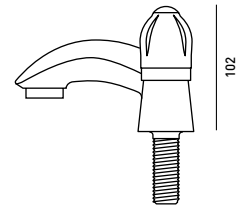

170

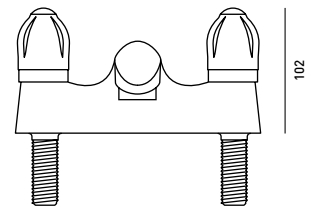

230

178 centers

DART

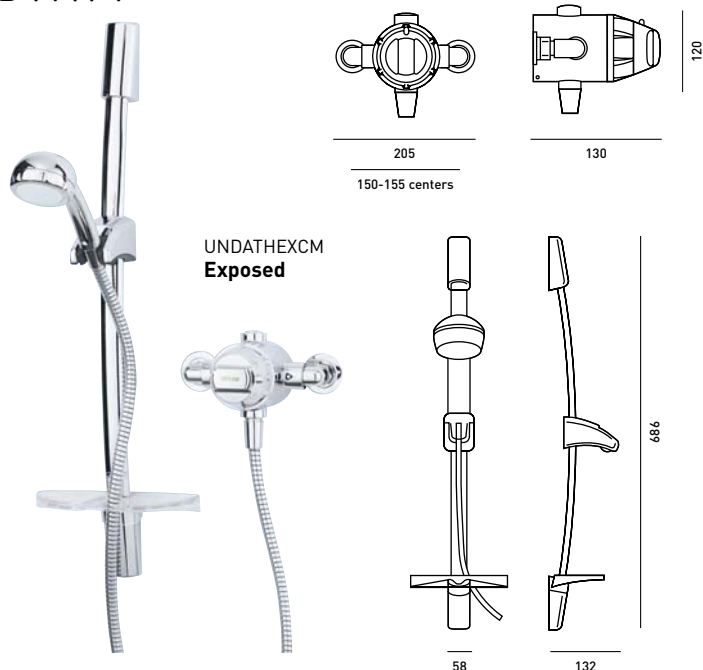

UNDATHEXCM
Exposed

Mixer valve type	Thermostatic
Operation	Dual control
Pressure range	0.1 bar - 5 bar
Maximum static pressure	10 bar
Minimum flow required to both inlets	8 litres per minute
Plumbing system	All, nominally equal pressures
Connections: Inlet	1/2" BSP
Connections: Outlet	1/2" BSP bottom
Water supplies	Rising, falling or rear entry via swivel inlet elbows

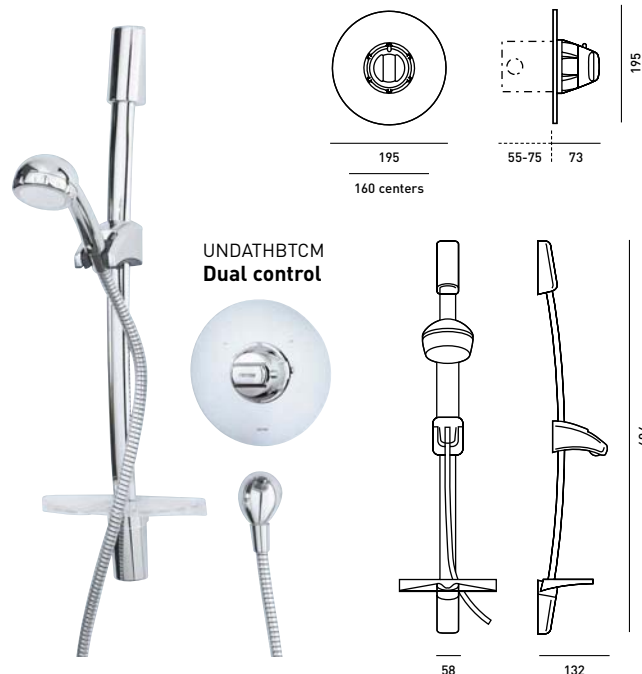

UNDATHTBCM
Dual control

Mixer valve type	Thermostatic
Operation	Dual control
Pressure range	0.1 bar - 5 bar
Maximum static pressure	10 bar
Minimum flow required to both inlets	8 litres per minute
Plumbing system	All, nominally equal pressures
Connections: Inlet	1/2" BSP
Connections: Outlet	Flat face union fittings
Water supplies	Rising, falling or rear entry

BAR MIXER INLET FITTINGS

There are three types of inlet fittings available for bar mixers as shown below:



Dog leg - standard on Exe and Aire.



Straight - standard on Nene and Tyne.
Available as an optional extra for Exe and Aire.
UNPIPCON

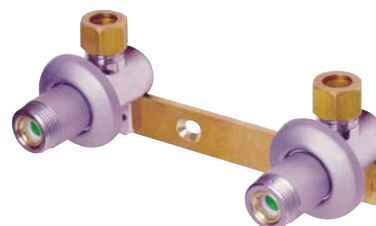

Bar Bracket - available as an optional extra for all bar mixers, or to wall mount any bath/shower mixers.
UNBMXBKT

To contact Triton's Unichrome Customer Service
Department please call **08700 678 678**

Brochure Request Line Tel: +44 (0) 24 7632 4460
Sales Order Processing Tel: +44 (0) 24 7632 4470