

## COMBI 407/5

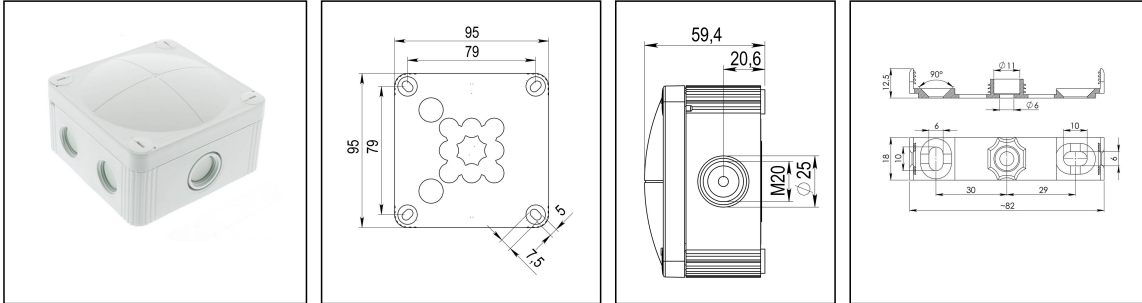

Product illustrations are exemplary and may differ from the chosen product. Further variants and individual customization, we will gladly provide you on request.



<b>Material</b>	Polypropylene
<b>Material sealing gasket</b>	TPE
<b>Temp. range min</b>	-30 °C
<b>Temp. range max</b>	100 °C
<b>Temperatures during install.</b>	-5 °C - 60 °C
<b>Protection class</b>	IP66/67
<b>Glow wire test</b>	750 °C
<b>Voltage</b>	690 V
<b>Terminals/poles</b>	4 mm <sup>2</sup>
<b>Terminals/poles</b>	5 x 4 mm <sup>2</sup>
<b>Fixing</b>	4 internal openings
<b>Ø cable diameter min</b>	3 mm
<b>Ø cable diameter max</b>	12 mm
<b>External dimensions LxWxH</b>	95 x 95 x 60mm
<b>Type of cable gland</b>	M 20 x 1,5, M 25 x 1,5
<b>Using for cable gland</b>	
<b>Product Color</b>	RAL 7035
<b>WISKA-Order no.</b>	10105596
<b>Type</b>	COMBI 407/5
<b>Packing unit</b>	5
<b>ETIM-Classification</b>	EC002600

Remarks:

IP66: using the membrane entry

IP67: using the threaded entry together with ESKV cable gland

## Fixing:

With mounting clip or 4 internal openings outside of the sealing area

## Equipment:

- 6x M20 threaded membrane entries and 1 middle M20 threaded membrane entry with knockout to M25
- 2 membrane cable entries through rear
- 4 captive cover screws
- including mounting clip
- with terminal block 5-poles, 4mm<sup>2</sup>

## Spare parts

<b>SMB 308/407</b>	10101293
<b>SP-HKT 11/5 Terminal block</b>	22000406

16.12.2016

