

ZER 4-12

Strain relief ring, polycarbonate, RAL 7035

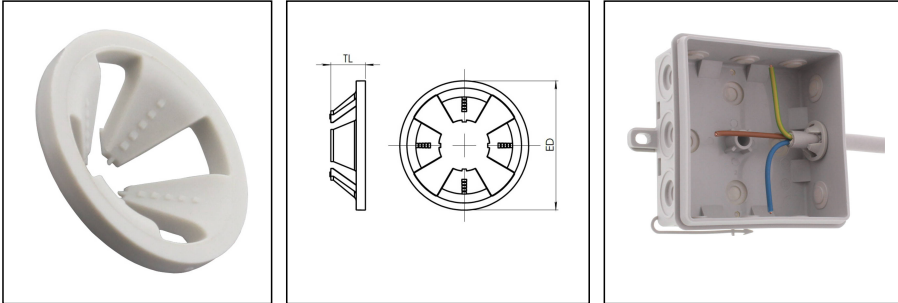

Products may differ in size, colour and appearance to those shown. If you require further information or customisation, please contact us directly.

Material	PC + ABS-Blend V0
Product Color	RAL 7035
Temp. range min	-30 °C
Temp. range max	100 °C
Ø cable diameter min	4 mm
Ø cable diameter max	12 mm
M_ML000127	19 mm
M_ML000132	5,5 mm
Type	ZER 4-12
WISKA-Order no.	10109800
Packing unit	10

23.06.2021

Your Contact:

WISKA UK Ltd.

Unit 7, Hurling Way · St. Columb Major Business Park · TR9 6SX, St. Columb Major, Cornwall · Great Britain

☎ +44-12-08816062 · 📠 +44-12-08816708

info@wiska.co.uk · www.wiska.co.uk

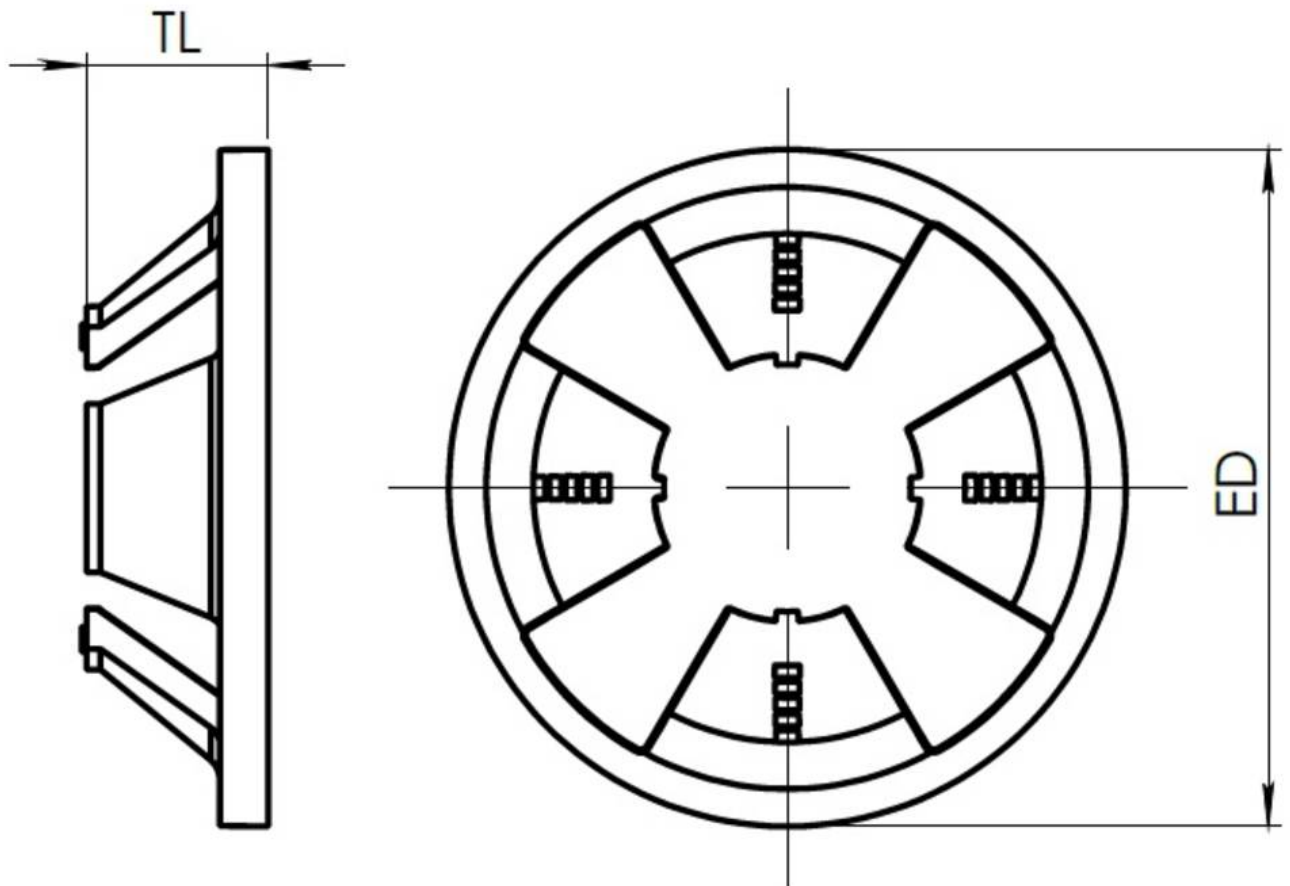

Your Contact:

WISKA UK Ltd.

Unit 7, Hurling Way · St. Columb Major Business Park · TR9 6SX, St. Columb Major, Cornwall · Great Britain

☎ +44-12-08816062 · 📠 +44-12-08816708

info@wiska.co.uk · www.wiska.co.uk