

INSTALLATION INSTRUCTIONS FOR THE 100mm 4"/120mm 5"/150mm 6" RANGE OF WALL/ BATHROOM/ TOILET EXTRACTOR FANS.

Zone Diagram

NOT TO SCALE

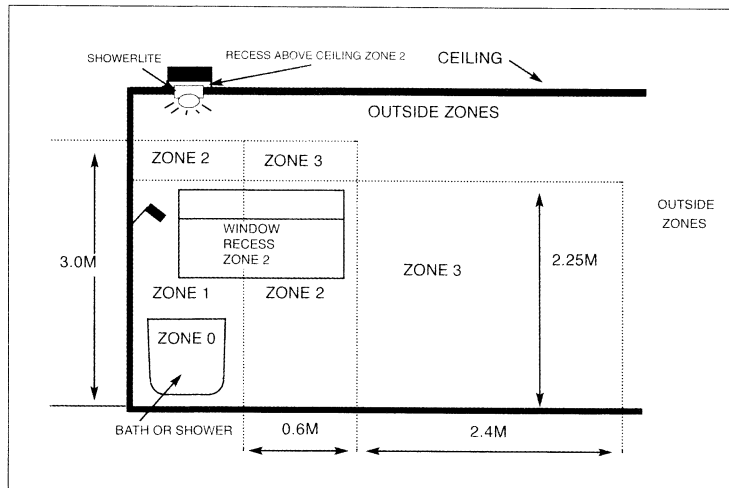

Degree of protection required by installed equipment			
ZONE 0	IPX7	ZONE 2	IPX4
ZONE 1	IPX4	ZONE 3	GENERAL RULES APPLY

IMPORTANT NOTES:

- (i) When installing fan through an external wall, an external wall grille must be fitted at all times.
 - (ii) This fan must be installed by fixed wiring only. A flexible cord should not be used.
 - (iii) A double pole fused spur having a contact separation of at least 3mm in all poles **MUST** be used and fitted with a 3 amp fuse, and must be sited outside any room containing a shower or fixed bath. The fan must not be accessible to a person using either the shower or bath. Fan to be fitted a minimum of 1.8 metres from floor. When fitting through an external wall, an external grille must be fitted at all times.
 - (iv) For best results this Extractor Fan should be fitted on the wall at the recommended height shown below, or if preferred, on the ceiling.
- | | | |
|-----------------|-----------------|------------------|
| 100mm 4" - 1.8m | 120mm 5" - 1.8m | 150 mm 6" - 2.2m |
|-----------------|-----------------|------------------|
- (v) Do not install the unit within a shower cubicle or anywhere else where there is a risk of being sprayed with water (see our range of shower fans). Please refer to zone diagram in this instruction.
 - (vi) Switch off mains supply before making electrical connections. All installations must be supervised by a qualified electrician.
 - (vii) This fan is double insulated and does not require an earth.

1. Cut a hole in the wall. If the fan is to be fixed in the ceiling ensure that the hole is between the joists. Fit ducting flush to the plaster. See below for appropriate hole size.

100mm 4" 112 mm 4 1/2	120mm 5" - 140 mm 5 1/2	150 mm 6" - 173 mm 6 3/4
-----------------------	-------------------------	--------------------------

2. Remove the cover from the fan by removing the two small screw caps on the front cover and remove the two retaining Philips screws.
3. Hold the body of the fan against the wall or ceiling and mark the four screw holes and the cable entry. **IMPORTANT:** Ensure that the fan is square on wall or ceiling.
4. Bring power cable into position, as marked. Allow an extra 230mm (9") protruding to facilitate connection.
5. **Wiring of Standard Model.**
Requires live and neutral power supply. Refer to internal wiring label for correct connection. The fan can either be operated from a separate pullcord switch fitted to the ceiling of the room or can be connected to the light switch so that the fan will start when the light is switched on.
6. **Wiring of Pullcord Models - (This model is not suitable for ceiling fixing)**
This fan has its own integral pullcord on/off switch. Requiring a live and neutral supply, refer to internal wiring label for correct connection.
7. **Wiring of Timer Model.**
This fan requires a neutral, switch live and permanent live supply. Refer to internal wiring label and Diagram 2 of this instruction for correct connection. The fan can either be operated from a separate pullcord switch fitted to the ceiling of the room or can be connected to the light switch so that the fan will start when the light is switched on.

For Timer Adjustment refer to the following diagrams:

- Diagram 5 for 100mm/4"
- Diagram 6 for 120mm/5"
- Diagram 7 for 150mm/6"

IMPORTANT

Switch off mains supply before making any electrical connections. Installation must be supervised by a qualified electrician.

This appliance is not intended for use by persons (including children) with reduced physical, sensory or mental capabilities, or lack of experience and knowledge, unless they have been given supervision or instruction concerning use of the appliance by a person responsible for their safety.

Children should be supervised to ensure that they do not play with the appliance.

Precautions must be taken to avoid the back-flow of gases into the room from the open flue of gas or other open-fire appliances when mounted in outside windows or walls.

Fan must be disconnected from electrical power before any maintenance is carried.

Humidity & Timer Models Wiring Diagram 100mm / 4" 120mm / 5" & 150mm / 6"

Diagram 2

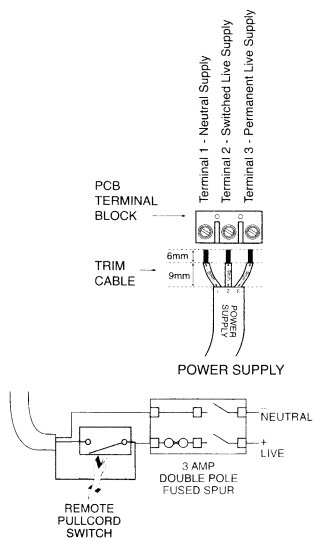
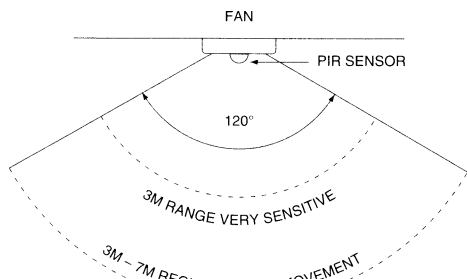
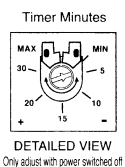

Diagram 3



PIR Fan

Diagram 3a



8. **Wiring of Humidity Model:**

(Time Delay with Humidity Sensor Over-ride) - Diagram 4

For the fan to operate a normal time delay unit with humidity over-ride i.e. when connected with a switch live coming from the light switch into the fan. The fan will operate when the light is switched on, and switch off after about 20 seconds to 20 minutes (timer is pre-set for the minimum). However should the humidity in the room reach about 75%, which will happen if the shower is run or the bath filled with hot water, the fan will switch on and keep running until the humidity has been reduced to a normal level, about 65%. Requires neutral, switch live and perm live supply. Refer to internal wiring label and Diag 2 of this instruction for correct connection.

Wiring of Humidity Model (Humidity Sensor with Pullcord Override)

This fan requires a permanent live and permanent neutral supply. Refer to internal wiring label for correct connection. The fan will operate should the humidity in the room reach to a higher level than the sensor detects and will run continuously until the humidity level is reduced.

The fan is fitted with a pullcord override that will operate the fan when the humidity is not high enough to operate the sensor.

Wiring of Humidity Model (Humidity Sensor Only)

This fan requires a permanent live and permanent neutral supply. Refer to internal wiring label for correct connection. The fan will operate should the humidity in the room reach to a higher level than the sensor detects and will run continuously until the humidity level is reduced.

9. **Electrical Connections: PIR Model with Timer**

This fan requires permanent live and permanent neutral supply. See internal wiring label for correct connection. The fan is sensitive to movement and will switch on when someone enters the room. Diagram 3 indicates the range of PIR sensor. When the room is vacated the fan will run for approximately one minute.

Timer adjustment (Diagram 3)

The time delay can be increased by firstly switching off the power to the fan, remove the front cover and insert a small screwdriver into the slot, as shown in Diagram 3a. Turning clockwise increases the time and turning anti-clockwise reduces the time.

10. **Wiring General (All Models)**

The fan **MUST** be connected to a double pole fused spur having a contact separation of at least 3mm in all poles. It must be used and fitted with a 3 amp fuse, and should be sited outside any room containing a shower or fixed bath. The fan should not be accessible to a person using either the shower or the bath. FOR ELECTRICAL RATING REFER TO FAN INTERNAL LABEL

Refer to Fan IP rating (see Internal Rating Label) for recommended safe siting of fan. REFER TO ZONE DIAGRAM 1.

NOTE: All wiring must be fixed securely and the cable to the fan should be a minimum of 1mm² in section. All wiring must comply with current I.E.E. Regulations. If in any doubt contact a qualified electrician.

Timer Adjustment Diagram 120mm/5"

Diagram 6

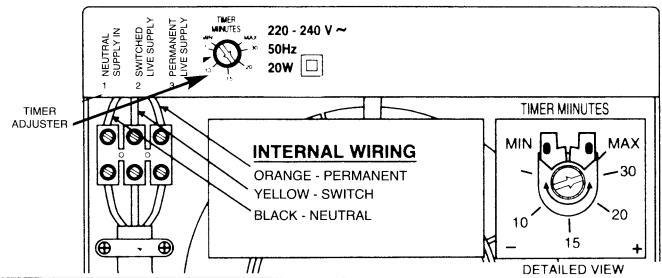
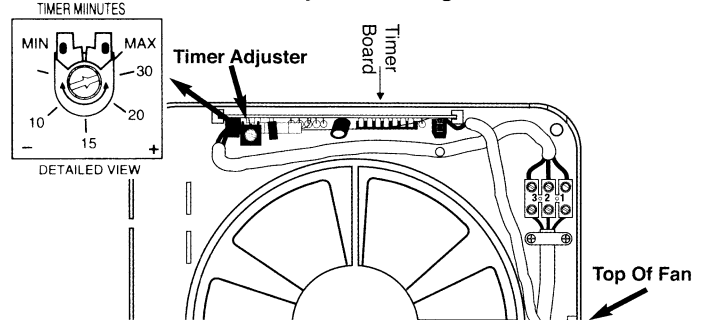

Diagram 7

Timer Adjustment diagram 150mm/6" Model



Timer Adjustment

The Timer fan will run approximately one minute after it has been switched off. This time delay can be increased by firstly switching off the power to the fan. Remove the cover and the timer cover as detailed in diagram 6a. Insert a small screwdriver into the slot, marked ↑ and turn clockwise to reduce the time and anti-clockwise to increase the time. **Only adjust with power switched off.** The timer will run for is 20 seconds and the maximum is about 20 minutes. **NB Timer delay is adjustable as indicated on the timer strip cover.**



For further information on any product, please telephone our Technical Hotline Number: 01753 876908

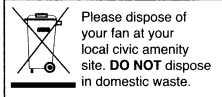

077001

1006

Diagram 4

Humidity/ Timer Adjustment Diagram for 100mm 4" / 120mm 5" models

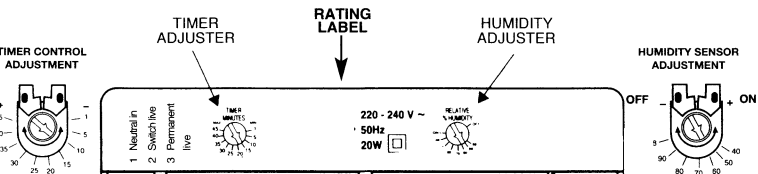

Humidity/ Timer Adjustment diagram for 150mm 6" models

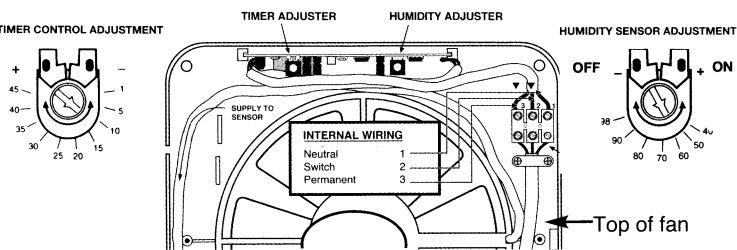

TIMER CONTROL ADJUSTMENT

- 1) Turn anti-clockwise to reduce time setting. Minimum time is 30 seconds.
- 2) Turn clockwise to increase time setting. Maximum time is 30 mins.

HUMIDITY SENSOR ADJUSTMENT

- 1) Turn anti-clockwise to increase sensitivity e.g. fan will stay on most of time (45-50%Rh)
- 2) Turn clockwise to reduce sensitivity e.g. fan will not switch on until humidity is very high (90-100%Rh)

Diagram 5

TOP VIEW

