

Thank you for purchasing a BNThermic product. Manufactured to a high standard, this product will, if used according to these instructions and properly maintained, give you years of trouble free performance.



REGISTER: PLEASE REGISTER THIS PRODUCT ONLINE TO ACTIVATE YOUR GUARANTEE AT
www.bnthermic.co.uk



IMPORTANT: PLEASE READ THESE INSTRUCTIONS, NOTE THE SAFE OPERATIONAL REQUIREMENTS, WARNINGS, AND CAUTIONS. USE THIS PRODUCT CORRECTLY, AND WITH CARE FOR THE PURPOSE FOR WHICH IT IS INTENDED. FAILURE TO DO SO MAY CAUSE DAMAGE AND/OR PERSONAL INJURY AND WILL INVALIDATE THE WARRANTY.

1. SAFETY INSTRUCTIONS

1.1 ELECTRICAL SAFETY

WARNING! It is the responsibility of the owner and the operator to read, understand and comply with the following:

You must check all electrical products, before use, to ensure that they are safe. You must inspect power cables, plugs, sockets and any other connectors for wear or damage. You must ensure that the risk of electric shock is minimised by the installation of appropriate safety devices. A Residual Current Circuit Breaker (RCCB) should be incorporated in the main distribution board. If in any doubt consult a qualified electrician.

You must also read and understand the following instructions concerning electrical safety.

- The Health & Safety at Work Act 1974 makes owners of electrical appliances responsible for the safe condition of those appliances and the safety of the appliance operators. If in any doubt about electrical safety, contact a qualified electrician.
- Installation should always be carried out by a qualified electrician or a competent person in accordance with current electrical regulation.
- Ensure that the insulation of all the cables on the appliance is undamaged and safe, before connecting it to the power supply.
- Ensure that the cables are always protected against short circuit and overload.
- Regularly inspect the power supply cables and plugs etc. for wear or damage and check all connections to ensure that none are loose.
- Important: Ensure that the voltage marked on the appliance matches the power supply to be used and that a correctly rated fuse is fitted.
- DO NOT use worn or damaged cables, plugs or connectors. Immediately have any faulty item repaired or replaced by a qualified electrician.
- The unit should be protected by a suitably rated isolator and fuse or MCB.
- This heater is IP20 rated and is suitable for indoor or under cover use only.
- Do not attach this heater to an extension cord it must be hard wired in position.

1.2 GENERAL SAFETY INSTRUCTIONS

- ✓ Remove all packaging and store it away from children, check the package and heater for visible damage or tampering.
- ✓ Familiarise yourself with the applications and limitations of the heater.
- ✓ Ensure the heater is in good order and condition both physically and electrically before use. If in any doubt, do not use the unit and contact your supplier.
- ✓ Only use recommended attachments and parts. To use unauthorised parts may be dangerous and will invalidate your warranty.
- ✓ Keep tools and other items away from the heater when it is in use.
- ✓ Keep children and unauthorised persons away from the heater, as it gets **hot**.
- ✓ Disconnect from mains and allow to cool before attempting any cleaning or maintenance.
- X **DO NOT** use in areas where hazardous gasses or dusts may be present.
- X **DO NOT** disassemble the heater for any reason. This heater must be checked by qualified personnel only.
- X **DO NOT** use this heater to perform a task for which it has not been designed.
- ❑ **WARNING!** This heater is not equipped with a built in device to control the room temperature. Do not use this heater in a small room if it is occupied by people not capable of leaving the room on their own, unless constant supervision is provided.
- ❑ **WARNING!** Ensure you observe the safety distances and mounting heights and there is no possibility of inflammable materials coming into contact.



2. INTRODUCTION & SPECIFICATION

This heater produces a totally dry heat, no condensation, no gas, no fumes. It reaches maximum heat output within a minute from being turned on. It is quick and easy to install reducing installation costs. Used with the CS-7 controller it can provide low / high heat or fan only settings.

Model	SMH-60
Power	6000W
Input supply	220-240V
Dimensions (W x D x H)	575 x 592 x 152mm
Weight	12.5kg
Recommended Mounting Height	2.4 - 3.0M
Safety Distance from Heater	1.5M
Optional Controller Model Number	CS-7



CS-7 Controller
(Optional Extra)



RST-TP Thermostat
(Optional Extra)

3. MOUNTING INSTALLATION

3.1 CEILING MOUNTING (Securing the heater directly to the ceiling)

IMPORTANT! Ensure that the ceiling is capable of taking the weight of the heater.

For optimum results, do not fit in ceilings higher than 3m. Air is taken in through the large centre grilles and discharged through the 2 x smaller outer grilles. The air intake and discharge areas must be kept completely clear for a minimum of 1.5m from the front of the heater. In an area using multiple units, heaters should be spread to provide an even heat distribution. You may well find it easier to connect the mains and control cables first although we do recommend you drill all the mounting holes first to ensure no load is taken on the power cables when installing. Remove the 12 screws on the front face guard ensuring you look after the screws as they are all needed after installation.

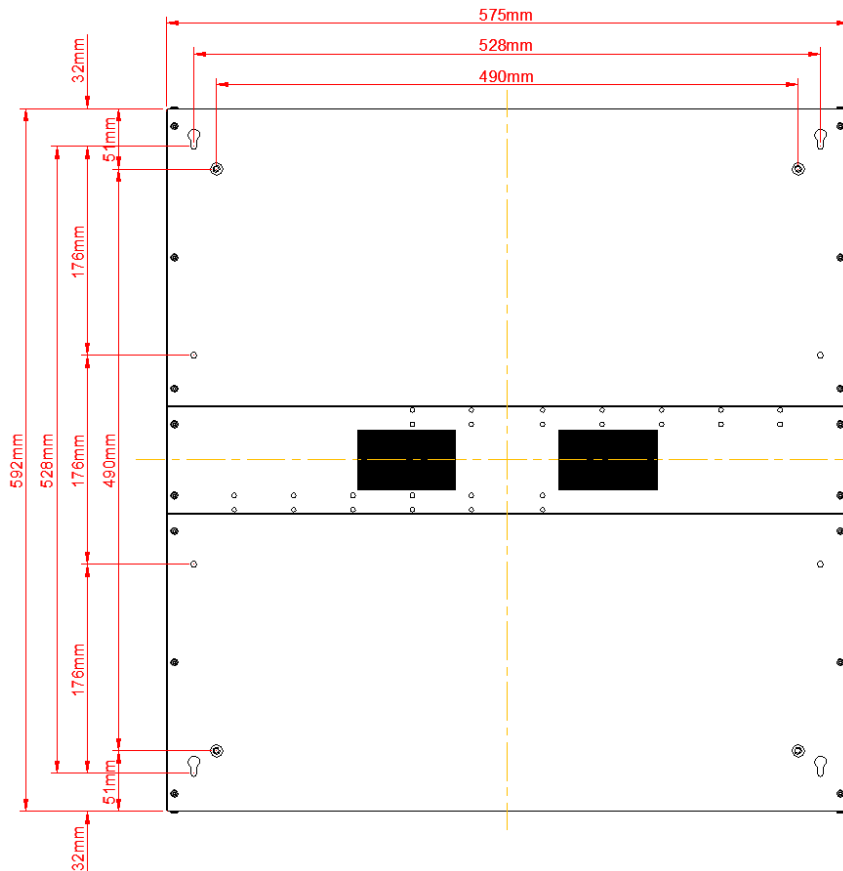

Using the drawing above mark out the holes required to secure the heater case to the ceiling. Use the 4 x keyhole slots and the additional 4 holes once installed to lock the heater in place. These additional 4 holes must be used to stop the possibility of the case sliding off its fixings. Secure to the ceiling using suitable fixings (not supplied).

3.2 DROP ROD MOUNTING

The heater has 4 x M6 threaded holes and 4 x M10 keyhole holes suitable for using M6 or M10 drop rod studding. If using the M6 threaded holes fully screw the studding into each hole and use a lock nut to stop it rotating and coming out. If using M10 studding a nut must be placed and tightened above and below the case on each of the 4 studs to hold the case securely to the M10 drop rods. Use the diagram above to determine the spacing of the drop rods. If you use drop rods you should be able to gain access to all the electrical connections once the heater is mounted to the ceiling.

3.3 CHAIN MOUNTING – USING SUPPLIED HANGING HOOKS

Place the nut onto each hook first then fully screw them into the heater, finally tighten the nuts against the heater body to stop them rotating.

4. ELECTRICAL CONNECTIONS

4.1 230V SINGLE PHASE – Without controls.

Please make sure you have read the Safety instructions and that you are a suitably qualified electrician before continuing.

Drawings show connections inside the black terminal box on the outside of the heater. **Do NOT use power tools to undo or do up terminal screws.**

Please Note:- Specified cable sizes are for typical installations, correction factors may need to be used when determining actual cable sizes.

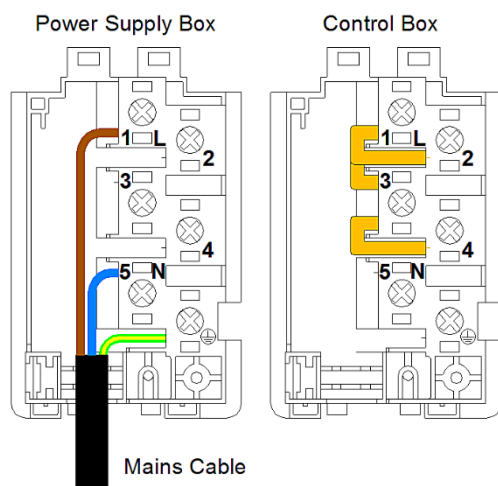

Standard Connection and Use

Use 4mm² 3 Core Mains Cable (see note above).

Connect Brown wire – Terminal 1 or L.

Connect Blue wire – Terminal 5 or N.

Connect Green / Yellow wire – Terminal E or

Ensure the 3 links are in position in the Control Box between terminals 1 and 2, 2 and 3, 3 and 4 as shown in drawing to the left.

If you wish to de-rate the heater from 6kW to 4kW remove the link between terminal 1 and terminal 2 in the Control Box. Ensure you tighten up the screws after removing the link. See drawing to the right.

PLEASE CHECK ALL CONNECTIONS BEFORE TURNING ON AS INCORRECT WIRING IS NOT COVERED BY THE GUARANTEE

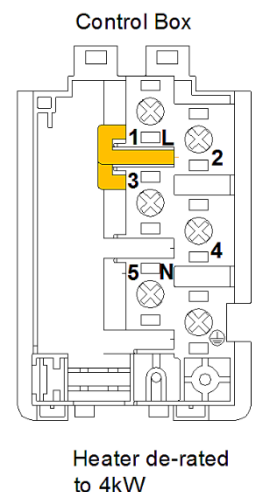

Heater de-rated to 4kW

4.2 230V SINGLE PHASE – With Thermostat (RST-TP).

Please make sure you have read the Safety instructions and that you are a suitably qualified electrician before continuing.

Drawings show connections inside the black terminal box on the outside of the heater and the inside of the RST-TP Thermostat. Other thermostats may be used BUT they must be suitable for a 10A load. **Do NOT use power tools to undo or do up terminal screws.**

Please Note:- Specified cable sizes are for typical installations, correction factors may need to be used when determining actual cable sizes.

Standard Connection using RST-TP Thermostat

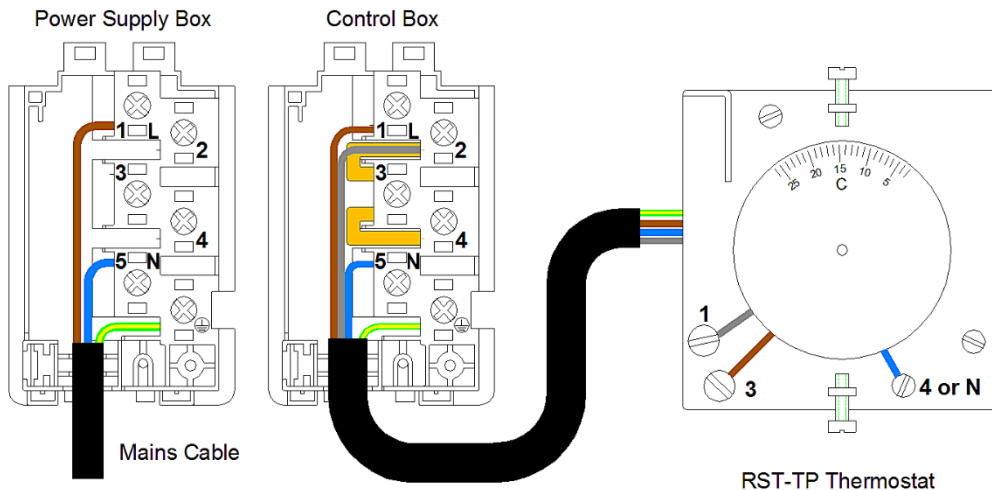

Use 4mm² 3 Core Mains Cable (see note above)

Use 1.5mm² 4 Core Cable to connect the heater (Control Box) to the thermostat (see note above).

Remove link  in heater control box between terminals 1 and 2.

Ensure the remaining 2 links are in position between terminals 2 and 3, 3 and 4 as shown in drawing to the left.

Mains Cable (Power Supply Box)

Connect Brown wire – Terminal 1 or L.
Connect Blue wire – Terminal 5 or N.
Connect Green / Yellow wire – Terminal E or 

Heater (Control Box) to Thermostat Cable – (Colours for reference only)

Connect Brown wire – Terminal 1 or L of heater and Terminal 3 of Thermostat.

Connect Grey wire – Terminal 2 of heater and Terminal 1 of Thermostat.

Connect Blue wire – Terminal 5 or N of heater and Terminal 4 or N of Thermostat.

Connect Green / Yellow wire – Terminal E or  of the heater and earth connection on Thermostat.

If you wish to de-rate the heater from 6kW to 4kW remove the link  between terminal 3 and terminal 4. Ensure you tighten up the screws after removing the link.

PLEASE CHECK ALL CONNECTIONS BEFORE TURNING ON AS INCORRECT WIRING IS NOT COVERED BY THE GUARANTEE

4.3 230V SINGLE PHASE – With CS-7 Controller (CS-7 Controller provides on / off / high heat / low heat / fan only settings).

Please make sure you have read the Safety instructions and that you are a suitably qualified electrician before continuing.

Drawings show connections inside the black terminal box on the outside of the heater and the inside of the CS-7 Controller.

Do NOT use power tools to undo or do up terminal screws.

Please Note:- Specified cable sizes are for typical installations, correction factors may need to be used when determining actual cable sizes.

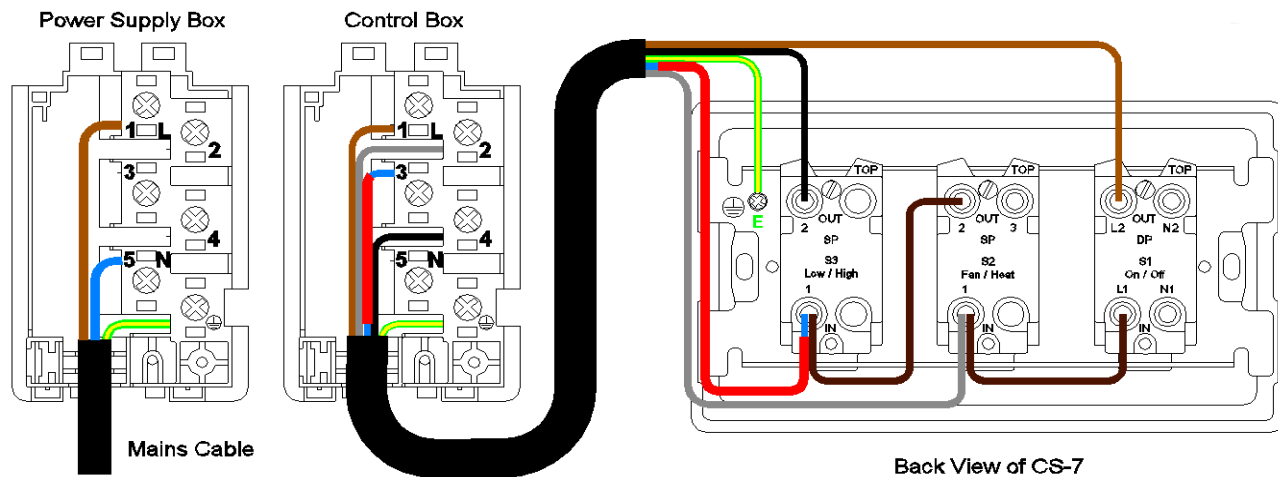

Standard Connection using CS-7 Controller

Use 4mm² 3 Core Mains Cable (see note above).

Use 1.5mm² 5 Core Cable to connect the heater (Control Box) to the CS-7 Controller (see note above).

Remove any links  that may be present in heater control box between terminals 1,2,3,4 or 5.

Mains Cable (Power Supply Box)

Connect Brown wire – Terminal 1 or L.

Connect Blue wire – Terminal 5 or N.

Connect Green / Yellow wire – Terminal E or 

Heater to CS-7 Controller Cable – (Colours for reference only)

Connect Brown wire – Terminal 1 or L of heater and Top Terminal L2 on right DP Switch of CS-7.

Connect Grey wire – Terminal 2 of heater and Centre switch Terminal 1 of CS-7.

Connect Blue wire (adding red or another suitable colour sleeve to both ends first) – Terminal 3 of heater and Terminal 1 on Left SP Switch of CS-7.

Connect Black wire – Terminal 4 of heater and Terminal 2 on left SP Switch of CS-7.

Connect Green / Yellow wire – Terminal E or  of heater and earth connection on CS-7.

PLEASE CHECK ALL CONNECTIONS BEFORE TURNING ON AS INCORRECT WIRING IS NOT COVERED BY THE GUARANTEE

4.4 230V SINGLE PHASE – With CS-7 Controller and RST-TP Thermostat.

Please make sure you have read the Safety instructions and that you are a suitably qualified electrician before continuing.

Drawings show connections inside the black terminal box on the outside of the heater and the inside of the CS-7 and RST-TP Thermostat Controllers. Other thermostats may be used BUT they must be suitable for a 3kW load. **Do NOT use power tools to undo or do up terminal screws.**

Please Note:- Specified cable sizes are for typical installations, correction factors may need to be used when determining actual cable sizes.

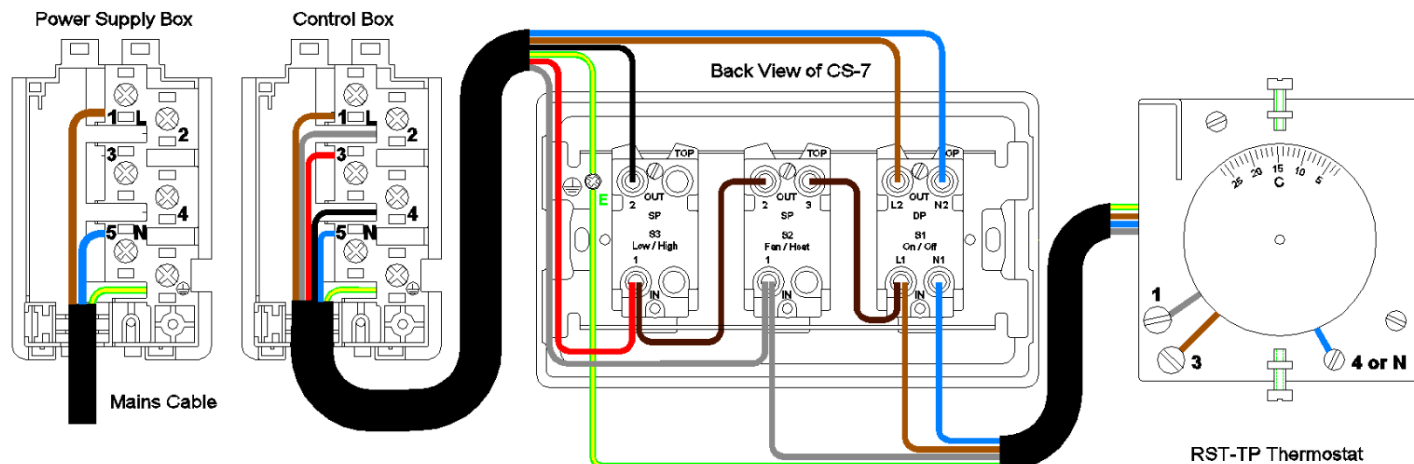

Standard Connection using CS-7 Controller and Thermostat

Use 4mm² 3 Core Mains Cable (see note above).

Use 1.5mm² 6 Core Cable to connect the heater (Control Box) to the CS-7 Controller (see note above).

Use 1.5mm² 4 Core Cable to connect the CS-7 Controller to Thermostat (see note above).

Remove any links  that may be present in heater control box between terminals 1,2,3,4 or 5.

Mains Cable (Power Supply Box)

Connect Brown wire – Terminal 1 or L.

Connect Blue wire – Terminal 5 or N.

Connect Green / Yellow wire – Terminal E or 

Heater (Control Box) to CS-7 Controller Cable – (Colours for reference only)

Move the Dark Brown link cable from the centre switch terminal 1 to the centre switch terminal 3 (shown above by dark brown wire).

Connect Brown wire – Terminal 1 or L of heater and Top Terminal L2 on right DP Switch of CS-7.

Connect Grey wire – Terminal 2 of heater and Centre Switch Terminal 1 of CS-7.

Connect Red wire – Terminal 3 of heater and Terminal 1 on Left SP Switch of CS-7.

Connect Black wire – Terminal 4 of heater and Terminal 2 on Left SP Switch of CS-7.

Connect Blue wire – Terminal 5 or N of heater and Top Terminal N2 on right DP Switch of CS-7.

Connect Green / Yellow wire – Terminal E or  of heater and earth connection on CS-7.

CS-7 Controller to Thermostat Cable – (Colours for reference only)

Connect Brown wire – Bottom Terminal L1 on right DP Switch of CS-7 and Terminal 3 of the Thermostat.

Connect Grey wire – Terminal 1 of middle Switch of CS-7 and Terminal 1 of the Thermostat.

Connect Blue wire – Bottom Terminal N1 on right DP Switch on CS-7 and Terminal 4 or N of the Thermostat.

Connect Green / Yellow wire – Terminal E or  of CS-7 and earth connection of the Thermostat.

PLEASE CHECK ALL CONNECTIONS BEFORE TURNING ON AS INCORRECT WIRING IS NOT COVERED BY THE GUARANTEE

5. MAINTENANCE

Note: Before examining or carrying out any maintenance ensure the heater has cooled down and is disconnected from the mains supply.

The heaters are intended to operate for many years, problem free. All moving parts are factory lubricated and therefore should require no service. Maintenance is limited to keeping both the inlet and outlet areas free from any accumulation of dust or any other foreign materials. This is especially important immediately before the heating season. Any dust build up can be loosened using a brush and a vacuum cleaner applied to the airways to ensure completed removal of any dust. When the heater is first turned on after cleaning an unusual odour may be noted this is due to the dust particles which inevitably will be disturbed and will be burnt off from the heating element.

If in any doubt always consult a qualified electrician for advice.

6. AUTO CUT OUT / FUSE REPLACEMENT

Each heater element is fitted with a semi-automatic safety device to prevent overheating. The device will isolate the heating element while the fan continues to operate. Should this occur, disconnect the heater from the mains supply for a minimum of 5 minutes, check and remove any foreign materials around the airways. If the element fails to operate or the safety cut out operates again, turn off the heater and contact a qualified electrician. This unit is fused and the fuse holder is located on the inside of the heater near the internal wire connection boxes. Should the fuse fail, ensure the heater has cooled down and is disconnected from the mains supply before replacing with another 10A fuse. If this replacement fuse fails seek professional help.

NOTE: It is our policy to continually improve products and as such we reserve the right to alter data, specifications and component parts without prior notice.



This product conforms to EU Directive 2002/96/EC.

This appliance bears the symbol of the crossed waste bin. This indicates that, at the end of its useful life, it must not be disposed of as domestic waste, but must be taken to a collection centre for waste electrical and electronic equipment. It is the user's responsibility to dispose of this appliance through the appropriate channels. Failure to do so may incur penalties established by laws governing waste disposal.

IMPORTANT: No liability is accepted for incorrect use of this product.

WARRANTY: Your BN Thermic product is guaranteed for one year from date of purchase. We will repair or replace at our discretion any part found to be defective. We cannot assume any consequential liability. This guarantee in no way prejudices your rights under common law and is offered as an addition to consumer liability rights.

REGISTER: Activate your warranty by registering online at www.bnthermic.co.uk and retain this installation data for future reference.

BN Thermic Ltd,
34 Stephenson Way,
Crawley, RH10 1TN
Tel: +44 (0) 1293 547361
Email: sales@bnthermic.co.uk
Web: www.bnthermic.co.uk