

CONTACTUM

DX016DC, DX025DC, DX032DC

Isolator DC-21B IP66 Rating 4 Pole 16-32A







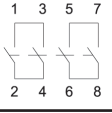
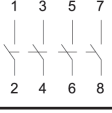
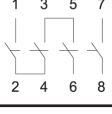
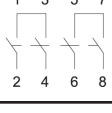
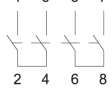

Technical Specification

Total Net Weight Excluding Packaging (g)	230 mm
Width (mm)	98 mm
Height (mm)	180 mm
Depth inc Switch (mm)	115.5 mm
Function	Isolation, Control
Standard	IEC60947-3, DC-21B
Number of Poles	4
Rated Voltage (Ue)	1200V DC
Rated Current (In)	16A, 25A, 32A
Rated Insulation Voltage (Ui)	1200V DC
Rated Impulse Voltage (Uimp)	8 kV
Mechanical Life	20000 Operations
Screw Torque (Nm)	1.2 Nm
Cable Size (mm ²)	4-16 mm ²
Protection Level	IP66
Ambient Operating Temperature	-25C +85C

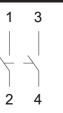
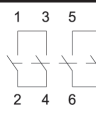
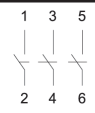
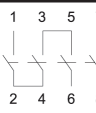
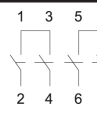
Contactum Ltd, Victoria Works, Edgware Road, London, NW2 6LF, United Kingdom. Company registration number: 06835712, VAT registration number: GB972 231 722

CONTACTUM

Wiring Diagram	DC21B/DC-PV1		Poles in Series	Number of Strings
	600V DC	1000V DC		
	29A	10A	2	1
	36A	11.5A	2	1
	55A	13A	2	1
	16A	10A	2	2
	25A	11.5A	2	2
	32A	13A	2	2
	16A	16A	4	1
	25A	25A	4	1
	32A	32A	4	1
	16A	16A	4	1
	25A	25A	4	1
	32A	32A	4	1
	16A	16A	4	1
	25A	25A	4	1
	32A	32A	4	1

Type	2-Pole	2+2 Pole 2 Poles in Series +2 Poles Parallel	4-Pole	4-Pole with Jumpers Input on Top Output on Bottom	4-Pole with Jumpers Input and Output on Bottom
Wiring Diagram					
Switching Example					

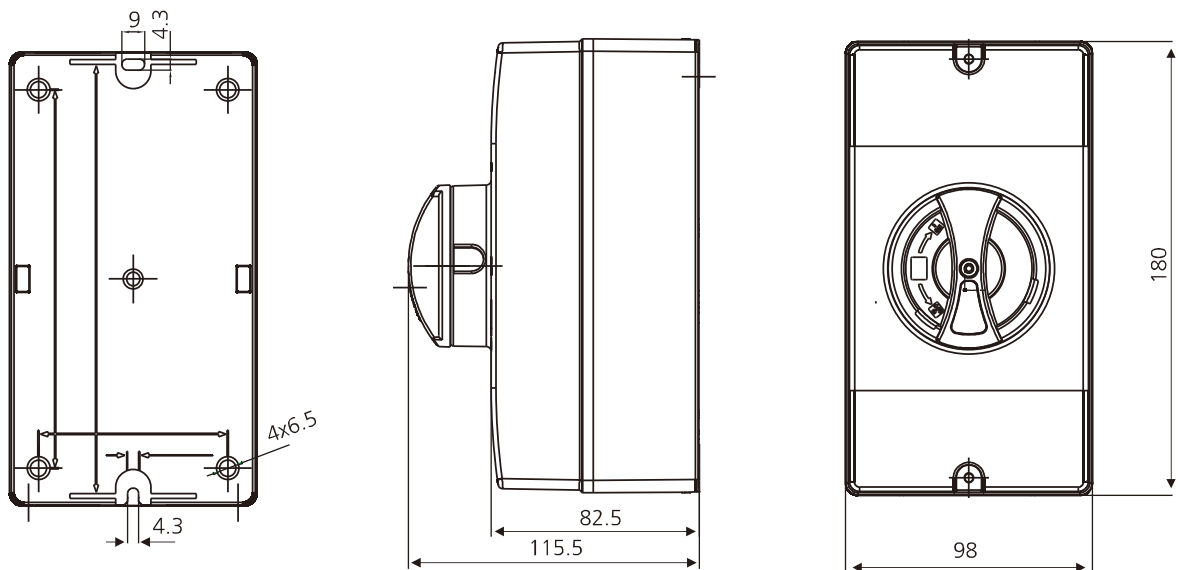

Contactum Ltd, Victoria House, 2 Blackmoor Lane, Watford, WD18 8GA, United Kingdom. Company registration number: 06835712, VAT registration number: GB972 231 722